

Hypertherm[®]

powermax45[®]

Plasma arc cutting system



Operator Manual – 805780
Revision 1

Register your new Hypertherm system

Register your product on-line at www.hypertherm.com/registration for easier technical and warranty support. You can also receive updates on new Hypertherm products and a free gift as a token of our appreciation.

For your records

Serial number: _____

Purchase date: _____

Distributor: _____

Maintenance notes:

powermax45

Operator Manual

(P/N 805780)

Revision 1 – October 2010

**Hypertherm, Inc.
Hanover, NH USA
www.hypertherm.com
email: info@hypertherm.com**

**© Copyright 2010 Hypertherm, Inc.
All Rights Reserved**

**Hypertherm and Powermax are trademarks of Hypertherm, Inc.
and may be registered in the United States and/or other countries.**

Hypertherm, Inc.

Etna Road, P.O. Box 5010
Hanover, NH 03755 USA
603-643-3441 Tel (Main Office)
603-643-5352 Fax (All Departments)
info@hypertherm.com (Main Office Email)
800-643-9878 Tel (Technical Service)
technical.service@hypertherm.com (Technical Service Email)
800-737-2978 Tel (Customer Service)
customer.service@hypertherm.com (Customer Service Email)

Hypertherm Automation

5 Technology Drive, Suite 300
West Lebanon, NH 03784 USA
603-298-7970 Tel
603-298-7977 Fax

Hypertherm Plasmatechnik GmbH

Technologiepark Hanau
Rodenbacher Chaussee 6
D-63457 Hanau-Wolfgang, Deutschland
49 6181 58 2100 Tel
49 6181 58 2134 Fax
49 6181 58 2123 (Technical Service)

Hypertherm (S) Pte Ltd.

82 Genting Lane
Media Centre
Annexe Block #A01-01
Singapore 349567, Republic of Singapore
65 6841 2489 Tel
65 6841 2490 Fax
65 6841 2489 (Technical Service)

Hypertherm (Shanghai) Trading Co., Ltd.

Unit A, 5th Floor, Careri Building
432 West Huai Hai Road
Shanghai, 200052
PR China
86-21 5258 3330/1 Tel
86-21 5258 3332 Fax

Hypertherm Europe B.V.

Vaartveld 9
4704 SE
Roosendaal, Nederland
31 165 596907 Tel
31 165 596901 Fax
31 165 596908 Tel (Marketing)
31 165 596900 Tel (Technical Service)
00 800 4973 7843 Tel (Technical Service)

Hypertherm Japan Ltd.

Level 9, Edobori Center Building
2-1-1 Edobori, Nishi-ku
Osaka 550-0002 Japan
81 6 6225 1183 Tel
81 6 6225 1184 Fax

Hypertherm Brasil Ltda.

Avenida Doutor Renato de
Andrade Maia 350
Parque Renato Maia
CEP 07114-000
Guarulhos, SP Brasil
55 11 2409 2636 Tel
55 11 2408 0462 Fax

Hypertherm México, S.A. de C.V.

Avenida Toluca No. 444, Anexo 1,
Colonia Olivar de los Padres
Delegación Álvaro Obregón
México, D.F. C.P. 01780
52 55 5681 8109 Tel
52 55 5683 2127 Fax

ELECTROMAGNETIC COMPATIBILITY (EMC)

Introduction

Hypertherm's CE-marked equipment is built in compliance with standard EN60974-10. The equipment should be installed and used in accordance with the information below to achieve electromagnetic compatibility.

The limits required by EN60974-10 may not be adequate to completely eliminate interference when the affected equipment is in close proximity or has a high degree of sensitivity. In such cases it may be necessary to use other measures to further reduce interference.

This cutting equipment is designed for use only in an industrial environment.

Installation and use

The user is responsible for installing and using the plasma equipment according to the manufacturer's instructions. If electromagnetic disturbances are detected then it shall be the responsibility of the user to resolve the situation with the technical assistance of the manufacturer. In some cases this remedial action may be as simple as earthing the cutting circuit, see *Earthing of Workpiece*. In other cases it could involve constructing an electromagnetic screen enclosing the power source and the work complete with associated input filters. In all cases electromagnetic disturbances must be reduced to the point where they are no longer troublesome.

Assessment of area

Before installing the equipment the user shall make an assessment of potential

electromagnetic problems in the surrounding area. The following shall be taken into account:

- a. Other supply cables, control cables, signalling and telephone cables; above, below and adjacent to the cutting equipment.
- b. Radio and television transmitters and receivers.
- c. Computer and other control equipment.
- d. Safety critical equipment, for example guarding of industrial equipment.
- e. Health of the people around, for example the use of pacemakers and hearing aids.
- f. Equipment used for calibration or measurement.
- g. Immunity of other equipment in the environment. User shall ensure that other equipment being used in the environment is compatible. This may require additional protection measures.
- h. Time of day that cutting or other activities are to be carried out.

The size of the surrounding area to be considered will depend on the structure of the building and other activities that are taking place. The surrounding area may extend beyond the boundaries of the premises.

Methods of reducing emissions

Mains supply

Cutting equipment must be connected to the mains supply according to the manufacturer's recommendations. If interference occurs, it may

be necessary to take additional precautions such as filtering of the mains supply. Consideration should be given to shielding the supply cable of permanently installed cutting equipment, in metallic conduit or equivalent. Shielding should be electrically continuous throughout its length. The shielding should be connected to the cutting mains supply so that good electrical contact is maintained between the conduit and the cutting power source enclosure.

Maintenance of cutting equipment

The cutting equipment must be routinely maintained according to the manufacturer's recommendations. All access and service doors and covers should be closed and properly fastened when the cutting equipment is in operation. The cutting equipment should not be modified in any way except as set forth in and in accordance with the manufacturer's written instructions. For example, the spark gaps of arc striking and stabilizing devices should be adjusted and maintained according to the manufacturer's recommendations.

Cutting cables

The cutting cables should be kept as short as possible and should be positioned close together, running at or close to the floor level.

Equipotential bonding

Bonding of all metallic components in the cutting installation and adjacent to it should be considered. However, metallic components bonded to the workpiece will increase the risk that the operator could receive a shock by touching these metallic components and the electrode (nozzle for laser heads) at the same time. The operator should be insulated from all such bonded metallic components.

Earthing of workpiece

Where the workpiece is not bonded to earth for electrical safety, nor connected to earth because of its size and position, for example, ship's hull or building steelwork, a connection bonding the workpiece to earth may reduce emissions in some, but not all instances. Care should be taken to prevent the earthing of the workpiece increasing the risk of injury to users, or damage to other electrical equipment. Where necessary, the connection of the workpiece to earth should be made by a direct connection to the workpiece, but in some countries where direct connection is not permitted, the bonding should be achieved by suitable capacitances selected according to national regulations.

Note: the cutting circuit may or may not be earthed for safety reasons. Changing the earthing arrangements should only be authorized by a person who is competent to assess whether the changes will increase the risk of injury, for example, by allowing parallel cutting current return paths which may damage the earth circuits of other equipment. Further guidance is provided in IEC 60974-9, Arc Welding Equipment, Part 9: Installation and Use.

Screening and shielding

Selective screening and shielding of other cables and equipment in the surrounding area may alleviate problems of interference. Screening of the entire plasma cutting installation may be considered for special applications.

Attention

Genuine Hypertherm parts are the factory-recommended replacement parts for your Hypertherm system. Any damage or injury caused by the use of other than genuine Hypertherm parts may not be covered by the Hypertherm warranty, and will constitute misuse of the Hypertherm Product.

You are solely responsible for the safe use of the Product. Hypertherm does not and cannot make any guarantee or warranty regarding the safe use of the product in your environment.

General

Hypertherm, Inc. warrants that its Products shall be free from defects in materials and workmanship for the specific periods of time set forth herein and as follows: if Hypertherm is notified of a defect (i) with respect to the power supply within a period of two (2) years from the date of its delivery to you, with the exception of Powermax brand power supplies, which shall be within a period of three (3) years from the date of delivery to you, and (ii) with respect to the torch and leads within a period of one (1) year from its date of delivery to you, and with respect to torch lifter assemblies within a period of one (1) year from its date of delivery to you, and with respect to laser heads within a period of one (1) year from its date of delivery to you, and with respect to Automation products one (1) year from its date of delivery to you, with the exception of the EDGE Pro CNC and ArcGlide THC, which shall be within a period of two (2) years from the date of delivery to you.

This warranty shall not apply to any Powermax brand power supplies that have been used with phase converters. In addition, Hypertherm does not warranty systems that have been damaged as a result of poor power quality, whether from phase converters or incoming line power. This warranty shall not apply to any Product which has been incorrectly installed, modified, or otherwise damaged.

Hypertherm provides repair, replacement or adjustment of the Product as the sole and exclusive remedy, if and only if the warranty set forth herein properly is invoked and applies. Hypertherm, at its sole option, shall repair, replace, or adjust, free of charge, any defective Products covered by this warranty which shall be returned with Hypertherm's prior authorization (which shall not be unreasonably withheld), properly packed, to Hypertherm's place of business in Hanover, New Hampshire, or to an authorized Hypertherm repair facility, all costs, insurance and freight pre paid by the customer. Hypertherm shall not be liable for any repairs, replacement, or adjustments of Products covered by this warranty, except those made pursuant to this paragraph and with Hypertherm's prior written consent.

The warranty set forth above is exclusive and is in lieu of all other warranties, express, implied, statutory, or otherwise with respect to the Products or as to the results which may be obtained therefrom, and all implied warranties or conditions of quality or of merchantability or fitness for a particular purpose or against infringement. The foregoing shall constitute the sole and exclusive remedy for any breach by Hypertherm of its warranty.

WARRANTY

Distributors/OEMs may offer different or additional warranties, but Distributors/OEMs are not authorized to give any additional warranty protection to you or make any representation to you purporting to be binding upon Hypertherm.

Distributors/OEMs may offer different or additional warranties, but Distributors/OEMs are not authorized to give any additional warranty protection to you or make any representation to you purporting to be binding upon Hypertherm.

Patent indemnity

Except only in cases of products not manufactured by Hypertherm or manufactured by a person other than Hypertherm not in strict conformity with Hypertherm's specifications and in cases of designs, processes, formulae, or combinations not developed or purported to be developed by Hypertherm, Hypertherm will have the right to defend or settle, at its own expense, any suit or proceeding brought against you alleging that the use of the Hypertherm product, alone and not in combination with any other product not supplied by Hypertherm, infringes any patent of any third party. You shall notify Hypertherm promptly upon learning of any action or threatened action in connection with any such alleged infringement (and in any event no longer than fourteen (14) days after learning of any action or threat of action), and Hypertherm's obligation to defend shall be conditioned upon Hypertherm's sole control of, and the indemnified party's cooperation and assistance in, the defense of the claim.

Limitation of liability

In no event shall Hypertherm be liable to any person or entity for any incidental, consequential direct, indirect, punitive or exemplary damages (including but not limited to lost profits) regardless of whether such liability is based on breach of contract, tort, strict liability, breach of warranty, failure of essential purpose, or otherwise, and even if advised of the possibility of such damages.

National and local codes

National and local codes governing plumbing and electrical installation shall take precedence over any instructions contained in this manual. In no event shall Hypertherm be liable for injury to persons or property damage by reason of any code violation or poor work practices.

Liability cap

In no event shall Hypertherm's liability, if any, whether such liability is based on breach of contract, tort, strict liability, breach of warranties, failure of essential purpose or otherwise, for any claim, action, suit or proceeding (whether in court, arbitration, regulatory proceeding or otherwise) arising out of or relating to the use of the Products exceed in the aggregate the amount paid for the Products that gave rise to such claim.

Insurance

At all times you will have and maintain insurance in such quantities and types, and with coverage sufficient and appropriate to defend and to hold Hypertherm harmless in the event of any cause of action arising from the use of the products.

Transfer of rights

You may transfer any remaining rights you may have hereunder only in connection with the sale of all or substantially all of your assets or capital stock to a successor in interest who agrees to be bound by all of the terms and conditions of this Warranty. Within thirty (30) days before any such transfer occurs, you agree to notify in writing Hypertherm, which reserves the right of approval. Should you fail timely to notify Hypertherm and seek its approval as set forth herein, the Warranty set forth herein shall be null and void and you will have no further recourse against Hypertherm under the Warranty or otherwise.



Safety information



Before operating any Hypertherm equipment, read the separate *Safety and Compliance Manual* (80669C) included with your product for important safety information.

Electromagnetic compatibility	EMC-1
Warranty.....	W-1

Section 1 SPECIFICATIONS

System description.....	1-2
Where to find information	1-2
Power supply dimensions and weights	1-3
Dimensions	1-3
Weights	1-3
Power supply ratings.....	1-4
T45v torch dimensions	1-5
T45m torch dimensions.....	1-5
T45v and T45m torch specifications.....	1-6
Symbols and markings.....	1-7
IEC symbols.....	1-8

Section 2 POWER SUPPLY SETUP

Unpack the Powermax45.....	2-2
Claims	2-2
Contents.....	2-2
Position the power supply.....	2-3
Prepare the electrical power	2-3
Voltage configurations.....	2-3
Install a line-disconnect switch	2-4
Requirements for grounding	2-4
Power cord considerations.....	2-5
Extension cord recommendations	2-5
Generator recommendations.....	2-7
Prepare the gas supply.....	2-7
Connect the gas supply.....	2-8
Additional gas filtration.....	2-8

Section 3 TORCH SETUP

Introduction	3-2
Consumable life.....	3-2
Hand torch setup	3-3
Choose the consumables.....	3-3
Install the consumables.....	3-5

TABLE OF CONTENTS

Machine torch setup.....	3-6
Mount the torch.....	3-6
Choose the consumables (cut charts).....	3-8
Align the torch.....	3-26
Connect the remote-start pendant.....	3-26
Connect a machine interface cable.....	3-27
Connect the torch lead.....	3-30

Section 4 OPERATION

Controls and indicators.....	4-2
Front controls and LEDs.....	4-2
Rear controls.....	4-3
Operate the Powermax45.....	4-4
Connect the electrical power and gas supply.....	4-4
Turn ON the system.....	4-4
Set the mode switch.....	4-5
Adjust the gas pressure.....	4-5
Check the indicator LEDs.....	4-6
Attach the work clamp.....	4-7
Understand duty-cycle limitations.....	4-7
How to use the hand torch.....	4-8
Operate the safety trigger.....	4-8
Hand torch cutting hints.....	4-9
Start a cut from the edge of the workpiece.....	4-10
Pierce a workpiece.....	4-11
Gouge a workpiece.....	4-12
Common hand-cutting faults.....	4-14
How to use the machine torch.....	4-15
Ensure the torch and table are set up correctly.....	4-15
Understand and optimize cut quality.....	4-15
To pierce a workpiece using the machine torch.....	4-17
Common machine-cutting faults.....	4-18

Section 5 MAINTENANCE AND REPAIR

Perform routine maintenance.....	5-2
Inspect the consumables.....	5-3
Basic troubleshooting.....	5-4
Repairs.....	5-8

Remove and replace the cover and Mylar® barrier..... 5-8
Replace the work lead (CSA and CE)5-10
Replace the gas filter element.....5-11

Section 6 PARTS

Power supply parts..... 6-2
T45v hand torch parts..... 6-5
 T45v hand torch consumables..... 6-6
 T30v (Powermax30) 30 A consumables 6-6
T45m machine torch parts..... 6-7
 T45m machine torch consumables..... 6-8
Accessory parts..... 6-8
Powermax45 labels 6-8

TABLE OF CONTENTS

Section 1

SPECIFICATIONS

In this section:

System description.....	1-2
Where to find information	1-2
Power supply dimensions and weights	1-3
Dimensions	1-3
Weights	1-3
Power supply ratings.....	1-4
T45v torch dimensions	1-5
T45m torch dimensions.....	1-5
T45v and T45m torch specifications.....	1-6
Symbols and markings.....	1-7
IEC symbols.....	1-8

System description

The Powermax45 is a highly portable, 45-amp, handheld and mechanized plasma cutting system appropriate for a wide range of applications. The Powermax45 uses air or nitrogen to cut electrically conductive metals, such as mild or stainless steel or aluminum. With it, you can cut thicknesses up to 1 inch (25.4 mm) and pierce thicknesses up to 3/8 inch (9.5 mm).

The standard Powermax45 system includes a complete set of the consumables needed for cutting (shield, retaining cap, swirl ring, nozzle, electrode), 2 spare electrodes, 2 spare nozzles, gouging consumables (handheld configurations only), a quick-disconnect air fitting (1/4 NPT on CSA units and 1/4 NPT x G-1/4 BSPP on CE units), a consumables box, a shoulder strap, an Operator Manual, a Quick Setup Card, and a Setup DVD. Mechanized configurations include a remote-start pendant as well.

You can order additional consumables and accessories – such as the plasma cutting guide – from any Hypertherm distributor. See Section 6, *Parts*, for a list of spare and optional parts.

The power cords on the CSA power supplies are shipped with a 50 A, 250 V plug (NEMA 6-50P) on the power cord. The CE units are shipped without a plug on the power cord. See *Prepare the electrical power* in Section 2 for more information.

Where to find information

System specifications such as size, weight, detailed electrical specifications, and cut speeds can be found in this section. For information on:

- Safety information — see the Safety and Compliance Manual for detailed safety information.
- Setup requirements, including power requirements, grounding, power cord configurations, extension cord requirements, and generator recommendations — see Section 2, *Power supply setup*.
- Handheld and machine torch consumables, cut charts, and torch setup information — see Section 3, *Torch setup*.
- Information about the controls and LEDs, steps for system operation, and hints for improving cut quality — see Section 4, *Operation*.
- Routine maintenance and repair — see Section 5, *Maintenance and repair*.
- Part numbers and ordering information for accessories, consumables, and replacement parts — see Section 6, *Parts*.

Power supply dimensions and weights

Dimensions

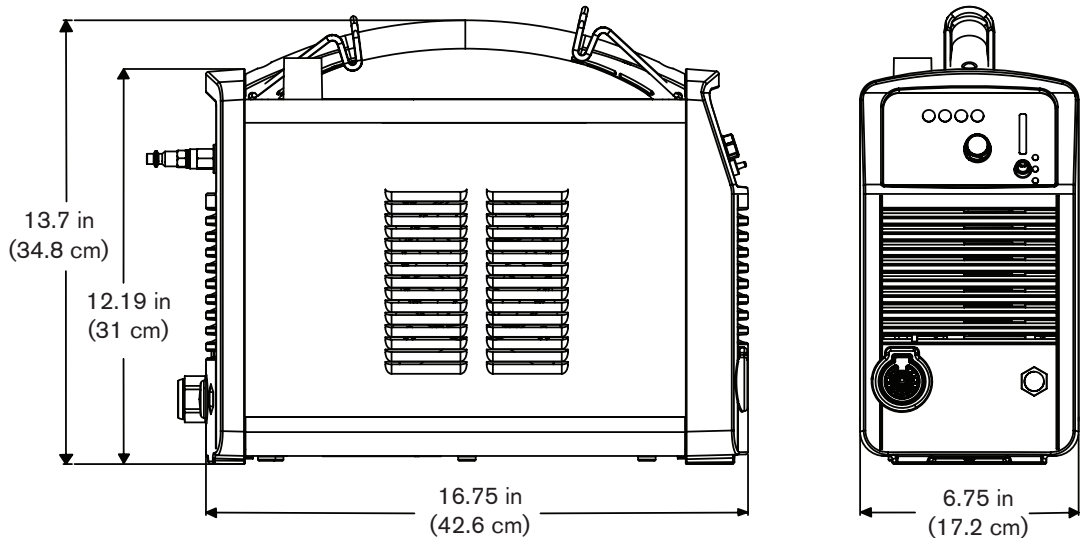

Weights

Power supply weights given below include the hand torch with 20 ft (6.1 m) lead, a 20 ft (6.1 m) work lead, and a 10 ft (3 m) power cord.

- CSA power supply: 37 lbs (16.8 kg)
- CE 230 V power supply: 36.5 lbs (16.6 kg)
- CE 400 V power supply: 35 lbs (15.9 kg)

SPECIFICATIONS

Power supply ratings

Rated open-circuit voltage (U_0) CSA/CE, single-phase CE, 3-phase	275 VDC	
Rated output current (I_2)	20 A to 45 A	
Rated output voltage (U_2)	132 VDC	
Duty cycle at 40° C (See data plate on power supply for more information on duty cycle.)	50 % ($I_2=45$ A, $U_2=132$ V) 60 % ($I_2=41$ A, $U_2=132$ V) 100 % ($I_2=32$ A, $U_2=132$ V)	
Operating temperature	14° to 104° F (-10° to 40° C)	
Storage temperature	-13° to 131° F (-25° to 55° C)	
Power factor 200–240 V CSA, 230 V CE, 1-phase 400 V, 3-phase CE	0.99 0.94	
Input voltage (U_1)/ Input current (I_1) at rated output ($U_{2\text{ MAX}}$, $I_{2\text{ MAX}}$) (See <i>Voltage configurations</i> in Section 3 for more information.)	200–240 VAC / 34–28 A (CSA) 230 VAC / 30 A (230 V CE)* 400 VAC 10 A (400 V CE)**	
Gas type	Air	Nitrogen
Gas quality	Clean, dry, oil-free per ISO 8573-1 Class 1.2.2	99.995 % pure
Recommended gas inlet flow and pressure	360 scfh @ 90 psi (170 l/min @ 6.2 bar)	

* Equipment complies with IEC 61000-3-12.

** Equipment complies with IEC 61000-3-12 provided that the short-circuit power S_{sc} is greater than or equal to 692 KVA at the interface point between the user's supply and the public system. It is the responsibility of the installer or user of the equipment to ensure, by consultation with the distribution network operator if necessary, that the equipment is connected only to a supply with a short-circuit power S_{sc} greater than or equal to 692 KVA.

T45v torch dimensions

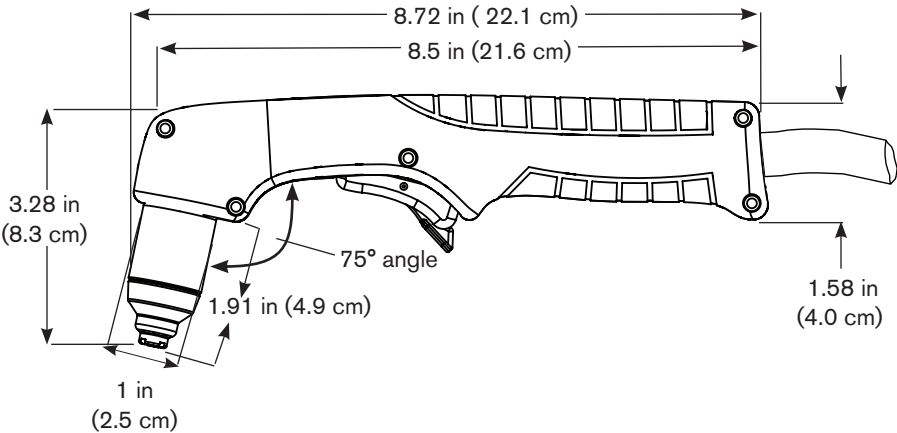

T45m torch dimensions

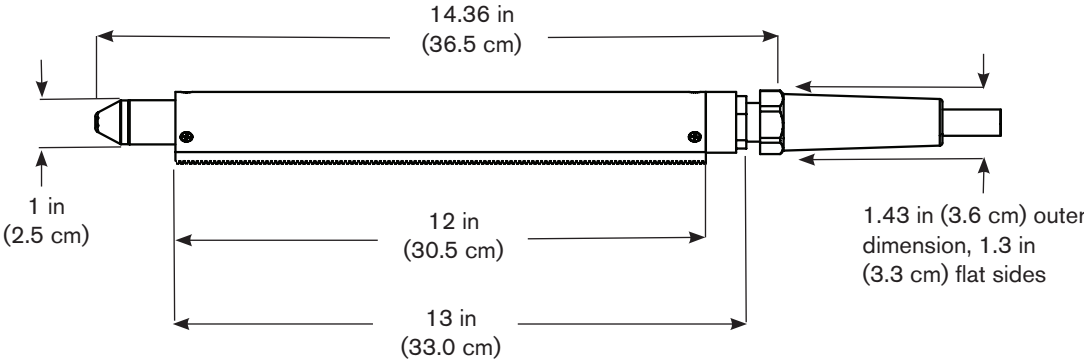

SPECIFICATIONS

T45v and T45m torch specifications

Handheld cut capacity (material thickness)	
Recommended cut capacity (hand cutting)	1/2 in (12.7 mm)
Maximum cut capacity (hand cutting or mechanized edge start)	3/4 in (19.1 mm)
Severance capacity (hand cutting or mechanized edge start)	1 in (25.4 mm)
Mechanized pierce capacity (material thickness)	
Pierce capacity (for edge starts, the capacities are the same as the handheld capacities)	3/8 in (9.5 mm)
Recommended cut speed (on mild steel)	
1/4 in (6.35 mm)	60 ipm (1524 mm/min)
3/8 in (9.53 mm)	32 ipm (813 mm/min)
1/2 in (12 mm)	20 ipm (508 mm/min)
3/4 in (18 mm)	8 ipm (203 mm/min)
1 in (24 mm)	4 ipm (102 mm/min)
Gouging capacity	
Metal removal rate on mild steel	6.2 lbs/hr (2.8 kg/hr)
Weight	
T45v torch only	0.6 lbs (0.27 kg)
T45v with 20 ft (6.1 m) lead	3.4 lbs (1.55 kg)
T45v with 50 ft (15.24 m) lead	7.8 lbs (3.54 kg)
T45m torch only	1.0 lbs (0.45 kg)
T45m with 25 ft (7.62 m) lead	5.0 lbs (2.27 kg)
T45m with 35 ft (10.7) lead	6.4 lbs (2.9 kg)
T45m with 50 ft (15.24) lead	8.5 lbs (3.85 kg)

Symbols and markings

Your Hypertherm product may have one or more of the following markings on or near the data plate. Due to differences and conflicts in national regulations, not all marks are applied to every version of a product.



S mark symbol

The S mark symbol indicates that the power supply and torch are suitable for operations carried out in environments with increased hazard of electrical shock per IEC 60974-1.



CSA mark

Hypertherm products with a CSA mark meet the United States and Canadian regulations for product safety. The products were evaluated, tested, and certified by CSA-International. Alternatively the product may have a mark by one of the other Nationally Recognized Testing Laboratories (NRTL) accredited in both the United States and Canada, such as Underwriters Laboratories, Incorporated (UL) or TÜV.



CE marking

The CE marking signifies the manufacturer's declaration of conformity to applicable European directives and standards. Only those versions of Hypertherm products with a CE marking located on or near the data plate have been tested for compliance with the European Low Voltage Directive and the European Electromagnetic Compatibility (EMC) Directive. EMC filters needed to comply with the European EMC Directive are incorporated within versions of the product with a CE marking.



GOST-R mark

CE versions of Hypertherm products that include a GOST-R mark of conformity meet the product safety and EMC requirements for export to the Russian Federation.



c-Tick mark

CE versions of Hypertherm products with a c-Tick mark comply with the EMC regulations required for sale in Australia and New Zealand.

















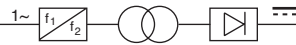



CCC mark

The China Compulsory Certification (CCC) mark indicates that the product has been tested and found compliant with product safety regulations required for sale in China.

SPECIFICATIONS

IEC symbols

The following symbols may appear on the power supply data plate, control labels, switches, and LEDs:

	Direct current (DC)		Power is ON
	Alternating current (AC)		Power is OFF
	Plasma torch cutting		An inverter-based power source, either 1-phase or 3-phase
	Plate metal cutting		
	Expanded metal cutting		Volt/amp curve, "drooping" characteristic
	Gouging		Power is ON (LED)
	AC input power connection		System fault (LED)
	The terminal for the external protective (earth) conductor		Inlet gas pressure (LED)
	Gas test mode		Missing or loose consumables (LED)
			Power supply is out of temperature range (LED)

Section 2

POWER SUPPLY SETUP

In this section:

Unpack the Powermax45.....	2-2
Claims	2-2
Contents.....	2-2
Position the power supply.....	2-3
Prepare the electrical power	2-3
Voltage configurations.....	2-3
Install a line-disconnect switch	2-4
Requirements for grounding	2-4
Power cord considerations.....	2-5
Extension cord recommendations	2-5
Generator recommendations.....	2-7
Prepare the gas supply.....	2-7
Connect the gas supply.....	2-8
Additional gas filtration.....	2-8

POWER SUPPLY SETUP

Unpack the Powermax45

1. Verify that all items on your order have been received in good condition. Contact your distributor if any parts are damaged or missing.
2. Inspect the power supply for damage that may have occurred during shipping. If there is evidence of damage, refer to *Claims*, below. All communications regarding this equipment must include the model number and the serial number located on the bottom of the power supply.
3. Before you set up and operate this Hypertherm system, read the Safety and Compliance Manual.

Claims

- **Claims for damage during shipment** – If your unit was damaged during shipment, you must file a claim with the carrier. Hypertherm will furnish you with a copy of the bill of lading upon request. If you need additional assistance, call the nearest Hypertherm office listed in the front of this manual.
- **Claims for defective or missing merchandise** – If any component is missing or defective, contact your Hypertherm distributor. If you need additional assistance, call the nearest Hypertherm office listed in the front of this manual.

Contents

Verify the items in the box against the illustration.

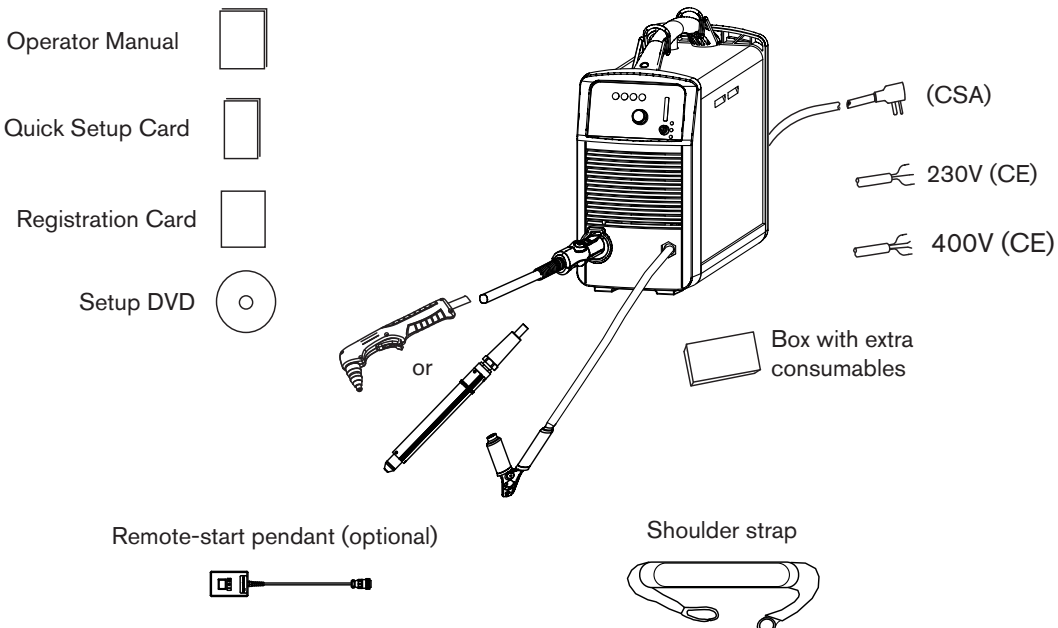

Position the power supply

Locate the Powermax45 near an appropriate 200–240 volt power receptacle for CSA or CE 1-phase power supplies, or a 400 volt receptacle for 3-phase CE power supplies. The Powermax45 has a 10-foot (3 m) power cord. Allow at least 10 inches (0.25 m) of space around the power supply for proper ventilation.

Prepare the electrical power

The maximum output voltage will vary based on your input voltage and the circuit's amperage. Because the current draw varies during startup, slow-blow fuses are recommended as shown in the chart below. Slow-blow fuses can withstand currents up to 10 times the rated value for short periods of time.

Voltage configurations

The following chart shows the maximum rated output for typical combinations of input voltage and amperage. Acceptable input voltages can be $\pm 10\%$ of the values given below.



Caution: Protect the circuit with appropriately sized time-delay (slow-blow) fuses and a line-disconnect switch.

Model	Input voltage	Phase	Rated output	Input current at 6 kw output	Input current during arc stretch	Recommended slow-blow fuse size
CSA	200 – 240 VAC	1	45 A, 132 V	34 – 28 A	55 – 45 A	50 A
	208 VAC	1	45 A, 132 V	33 A	54.5 A	50 A
CE	200 – 240 VAC	1	45 A, 132 V	34 – 28 A	55 – 45 A	35 or 50* A
	400 VAC	3	45 A, 132 V	10 A	15.5 A	15 or 20* A
CE/CCC	220 VAC	1	45 A, 132 V	31 A	53 A	35 or 50* A
	380 VAC	3	45 A, 132 V	11 A	14 A	15 A

* Use the higher amperage fuse for applications that require a long arc stretch.

Install a line-disconnect switch

Use a line-disconnect switch for each power supply so that the operator can turn off the incoming power quickly in an emergency. Locate the switch so that it is easily accessible to the operator. Installation must be performed by a licensed electrician according to national and local codes. The interrupt level of the switch must equal or exceed the continuous rating of the fuses. In addition, the switch should:

- Isolate the electrical equipment and disconnect all live conductors from the incoming supply voltage when in the OFF position.
- Have one OFF and one ON position that are clearly marked with O (OFF) and I (ON).
- Have an external operating handle that can be locked in the OFF position.
- Contain a power-operated mechanism that serves as an emergency stop.
- Have slow-blow fuses installed as recommended in the table on the previous page.

Requirements for grounding

To ensure personal safety, proper operation, and to reduce electromagnetic interference (EMI), the Powermax45 must be properly grounded:

- The power supply must be grounded through the power cord according to national and local electrical codes.
- Single-phase service must be of the 3-wire type with a green or green/yellow wire for the protective earth ground and must comply with national and local requirements. **Do not use a 2-wire service.**
- Three-phase service (CE only) must be of the 4-wire type with a green or green/yellow wire for the protective earth ground and must comply with national and local requirements.
- Refer to *Grounding safety* in the Safety and Compliance Manual for more information.

Power cord considerations

Powermax45 power supplies are shipped with CSA and CE power cord configurations.

The power cords on the CSA power supplies are shipped with a 50 A, 250 V plug (NEMA 6-50P) on the power cord.

The CE power supplies are shipped without a plug on the power cord. Obtain the correct plug for your unit (either 230 V or 400 V) and location have it installed by a licensed electrician.

Extension cord recommendations

Any extension cord must have an appropriate wire size for the cord length and system voltage. Use a cord that meets national and local codes.

The tables on the next page provides the recommended gauge size for various lengths and input voltages. The lengths in the tables are the length of the extension cord only; they do not include the power supply's power cord.

POWER SUPPLY SETUP

Extension cord recommendations

English

Input voltage	Phase	< 10 ft	10–25 ft	25–50 ft	50–100 ft	100–150 ft
208 VAC	1	8 AWG	8 AWG	8 AWG	6 AWG	4 AWG
220 VAC	1	8 AWG	8 AWG	8 AWG	6 AWG	4 AWG
200–240 VAC	1	8 AWG	8 AWG	8 AWG	6 AWG	4 AWG
380 VAC	3	12 AWG	12 AWG	12 AWG	10 AWG	10 AWG
400 VAC	3	12 AWG	12 AWG	12 AWG	10 AWG	10 AWG

Metric

Input voltage	Phase	< 3 m	3–7.5 m	7.5–15 m	15–30 m	30–45 m
208 VAC	1	10 mm ²	10 mm ²	10 mm ²	16 mm ²	25 mm ²
220 VAC	1	10 mm ²	10 mm ²	10 mm ²	16 mm ²	25 mm ²
200–240 VAC	1	10 mm ²	10 mm ²	10 mm ²	16 mm ²	25 mm ²
380 VAC	3	4 mm ²	4 mm ²	4 mm ²	6 mm ²	6 mm ²
400 VAC	3	4 mm ²	4 mm ²	4 mm ²	6 mm ²	6 mm ²

Generator recommendations

When using a generator with the Powermax45, it should produce 240 VAC nominal current.

Engine drive rating	Engine drive output current	Performance
8 KW	33 A	Good arc stretch at 45 A cutting current
6 KW	25 A	Limited arc stretch at 45 A cutting current Good arc stretch at 30 A cutting current

Notes: Based on the generator rating, age, and condition, adjust the cutting current as needed.

If a fault occurs while using a generator, turning the power switch quickly to OFF and then to ON again (sometimes called a “quick reset”) may not clear the fault. Instead, turn OFF the power supply and wait 30 to 45 seconds before turning to ON again.

Prepare the gas supply

The gas supply for the Powermax45 can be shop-compressed or cylinder-compressed. A high-pressure regulator must be used on either type of supply and must be capable of delivering gas to the filter on the power supply at 360 scfh @ 90 psi (170 l/min @ 6.2 bar).



WARNING

Do not allow the gas supply pressure to exceed 135 psi (9.3 bar). The filter bowl may explode if this pressure is exceeded.

If gas supply quality is poor, cut speeds decrease, cut quality deteriorates, cutting thickness capability decreases, and the life for consumables shortens. For optimum performance, the gas should have a maximum particle size of 0.1 micron at a maximum concentration of 0.1 mg/m³, a maximum dewpoint of -40° C (-40° F), and a maximum oil concentration of 0.1 mg/m³ (per ISO 8573-1 Class 1.2.2).

POWER SUPPLY SETUP

Connect the gas supply

Connect the gas supply to the power supply using an inert-gas hose with a 3/8 inch (9.5 mm) internal diameter and a 1/4 NPT quick-disconnect coupler, or a 1/4 NPT x G-1/4 BSPP (CE units) quick-disconnect coupler.

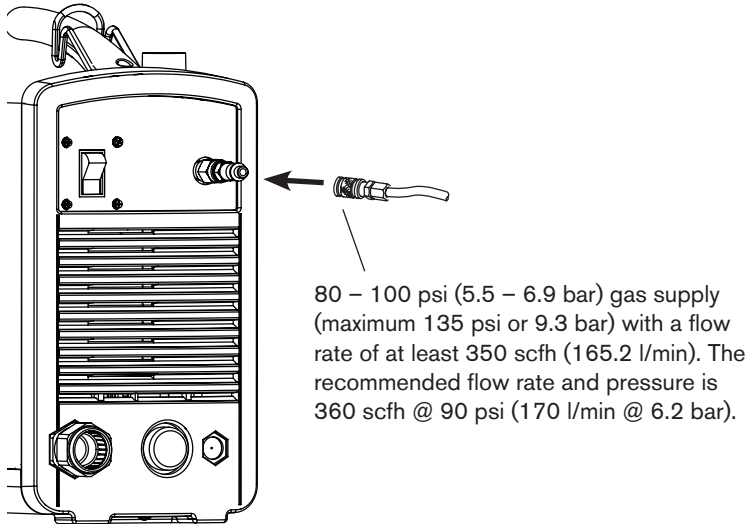

Additional gas filtration

When site conditions introduce moisture, oil, or other contaminants into the gas line, use a 3-stage coalescing filtration system, such as the Eliminer filter kit (part number 128647) available from Hypertherm distributors. A 3-stage filtering system works as shown below to clean contaminants from the gas supply.

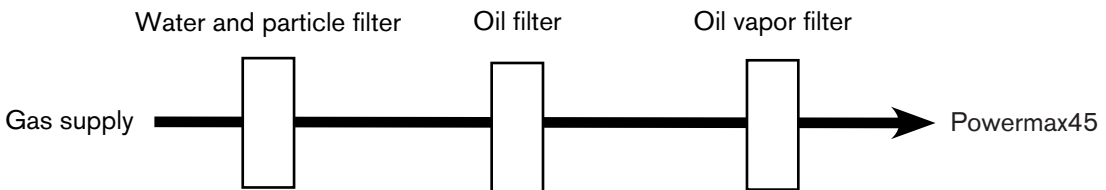

The filtering system should be installed between the quick-disconnect coupler and the power supply.

Section 3

Torch setup

In this section:

Introduction	3-2
Consumable life.....	3-2
Hand torch setup	3-3
Choose the consumables.....	3-3
Install the consumables.....	3-5
Machine torch setup.....	3-6
Mount the torch.....	3-6
Choose the consumables (cut charts).....	3-8
Align the torch.....	3-26
Connect the remote-start pendant.....	3-26
Connect a machine interface cable	3-27
Connect the torch lead.....	3-30

Introduction

Both T45v handheld torch and the T45m machine torch, are available for the Powermax45. The torch quick disconnect makes it easy to remove the torch for transport or to switch from one torch to the other if your applications require the use of both torches.

This section explains how to set up your torch and choose the appropriate consumables for the job.

Consumable life

How often you will need to change the consumables on your Powermax45 will depend on a number of factors:

- The thickness of the metal being cut.
- The length of the average cut.
- Whether you are doing machine or hand cutting.
- The air quality (presence of oil, moisture, or other contaminants).
- Whether you are piercing the metal or starting cuts from the edge.
- Proper torch-to-work distance when gouging or cutting with unshielded consumables.
- Proper pierce height.
- Which consumables you are using. The T30v (Powermax30) 30 A consumables will have a shorter life when used on the T45v. However, they provide optimum cut quality for certain applications.

Under normal conditions, the electrode will wear out first during machine cutting and the nozzle will wear out first when hand cutting.

A general rule is that a set of consumables lasts approximately 1 to 2 hours of actual “arc on” time for hand cutting, depending on these factors. For mechanized cutting, consumables should last about 3 to 5 hours.

You will find more information about proper cutting techniques in Section 4, *Operation*.

Hand torch setup

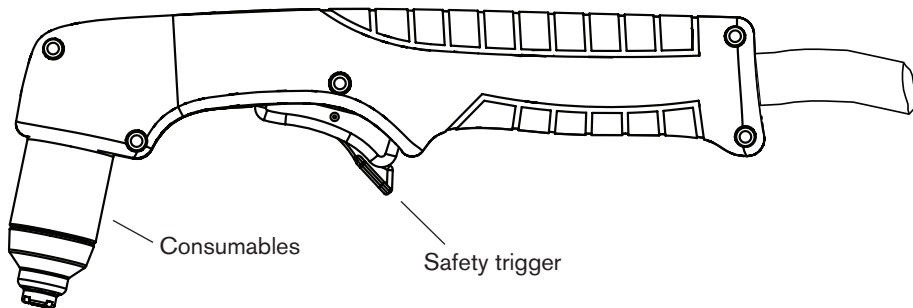

Choose the consumables

The Powermax45 with the T45v handheld torch comes with a full set of consumables for cutting installed on the torch, spare electrodes and nozzles in the consumables box, and consumables for gouging in the consumables box. In non-CE-regulated countries, you can also purchase unshielded consumables that are useful for certain applications.

With shielded consumables, you drag the torch tip along the metal to cut. With unshielded consumables, you must keep the torch a small distance, about .08 inch (2 mm), away from the metal. Unshielded consumables generally have a shorter life than shielded consumables; however, you may find that visibility and accessibility are better for some applications.

Consumables for hand cutting are shown on the next page. Notice that the retaining cap, swirl ring, and electrode are the same for shielded, unshielded, and gouging applications. Only the shield (deflector for unshielded consumables) and the nozzle are different.

For the best cut quality on thin stainless steel, you may prefer to reduce the amperage setting to 30 amps and use the T30v (Powermax30) 30 A consumables available from Hypertherm.

TORCH SETUP

T45v shielded consumables



220674
Shield

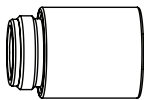

220713
Retaining cap

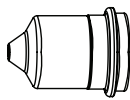

220671
Nozzle

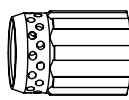

220670
Swirl ring

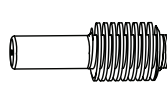

220669
Electrode

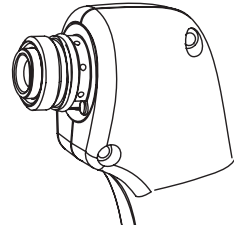

T45v gouging consumables

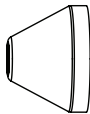

220675
Shield

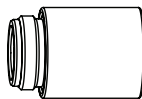

220713
Retaining cap



220672
Nozzle

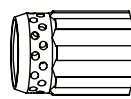

220670
Swirl ring

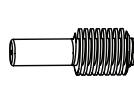

220669
Electrode

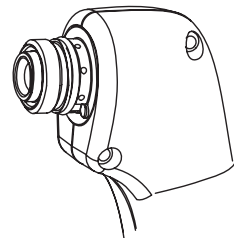

T45v unshielded consumables*



220717
Deflector

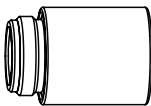

220713
Retaining cap

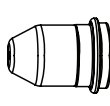

220718
Nozzle

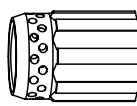

220670
Swirl ring

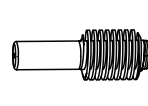

220669
Electrode

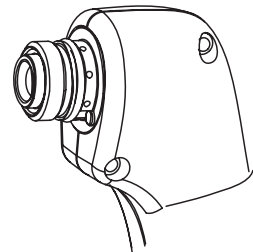

* Unshielded consumables are not available for use in CE-regulated countries.

T30v (Powermax30) 30 A consumables

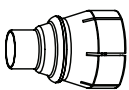

220569
Optional
deflector

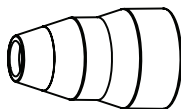

220483
Retaining cap

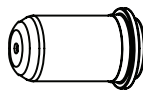

220480
Nozzle

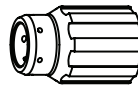

220479
Swirl ring

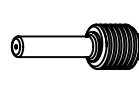

220478
Electrode

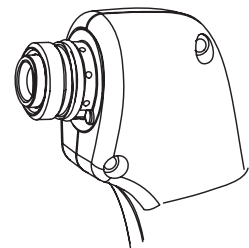

Install the consumables

		<p>WARNING INSTANT-ON TORCHES PLASMA ARC CAN CAUSE INJURY AND BURNS</p>
		<p>The plasma arc comes on immediately when the torch is activated. Make sure the power is OFF before changing the consumables.</p>

To operate the T45v torch, it must have a complete set of consumable parts installed: a shield or deflector, retaining cap, nozzle, swirl ring and electrode.

With the power switch in the OFF (O) position, verify that the torch consumables are installed as shown.

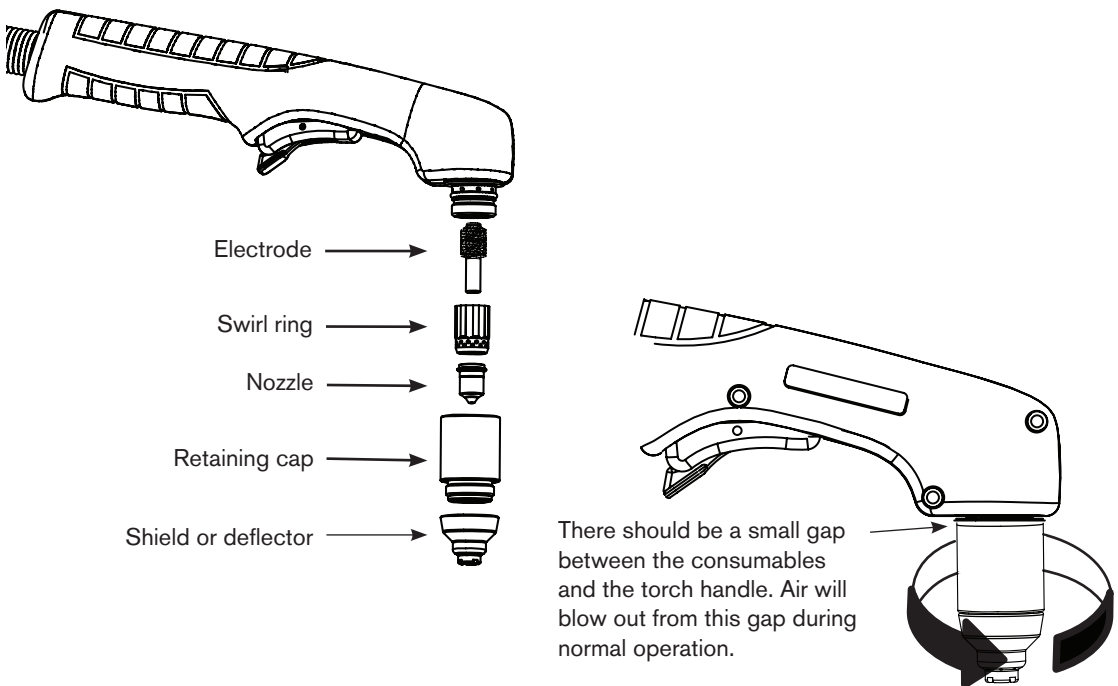

Note: Tighten only to finger-tight. Overtightening will cause the torch to misfire.

Machine torch setup

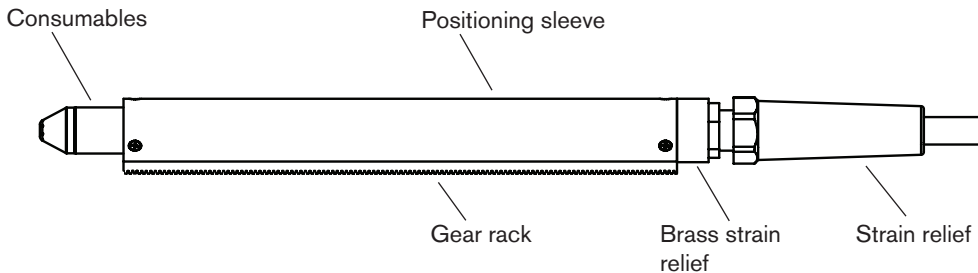

Before using the T45m, you must:

- Mount the torch on your cutting table or other equipment.
- Choose and install the consumables.
- Align the torch.
- Attach the torch lead to the power supply.
- Set up the power supply for remote starting with either the remote-start pendant or a machine interface cable.

Mount the torch

Depending on the type of cutting table you have, you may or may not need to disassemble the torch to route it through the track and mount it. If your cutting table's track is large enough for you to thread the torch through it without removing the torch body from the lead, do so and then attach the torch to the lifter per the manufacturer's instructions.

Note: The T45m can be mounted on a wide variety of X-Y tables, track burners, pipe bevelers, and other equipment. Install the torch per the manufacturer's instructions and following the instructions below for disassembly if necessary.

If you need to disassemble the torch, follow these steps:

1. Disconnect the torch lead from the power supply and remove the consumables from the torch.
2. Remove the gear rack from the positioning sleeve by removing the 2 black screws that secure it to the positioning sleeve. Remove the 6 screws (3 at each end) that secure the positioning sleeve to the brass strain relief and to the torch body. Slide the positioning sleeve off the torch.

3. Disconnect the wires for the cap-sensor switch at the connector in the middle.

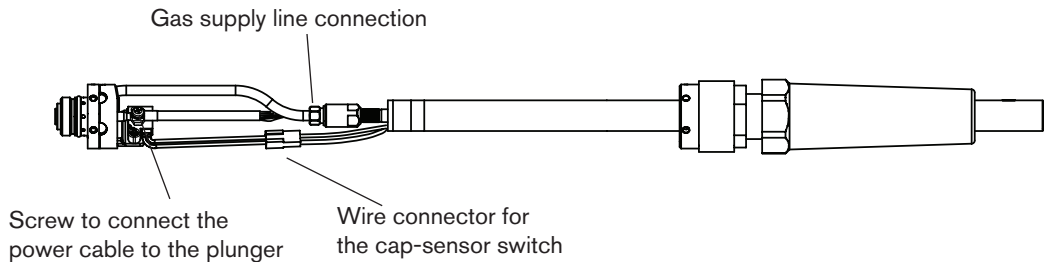





4. Use a #2 Phillips screwdriver and a 1/4-inch nut driver (or adjustable wrench) to remove the screw and nut that secure the torch's power cable to the plunger. (Turn the plunger if necessary to gain access to the screw.)
5. Use 5/16-inch (8 mm) and 3/8-inch (or adjustable) wrenches to loosen the nut that secures the gas supply line to the torch lead. Set the torch body aside.

Note: Cover the end of the gas line on the torch lead with tape to keep dirt and other contaminants from getting in the gas line when you route the lead through the track.
6. Route the torch lead through the cutting table's track.
7. Reattach the torch's power cable to the torch plunger using the screw and nut. Rotate the plunger so that the screw does not interfere with the cap-sensor switch.
8. Reconnect the gas line to the torch lead.
9. Press the two halves of the cap-sensor switch's wire connector together.
10. Slide the positioning sleeve over the torch body and check the alignment of the screw holes. Replace the three screws at each end.
11. If you will be using the gear rack, re-attach it with the 2 black screws you removed earlier.
12. Attach the torch to the lifter per the manufacturer's instructions.

TORCH SETUP

Choose the consumables (cut charts)

		WARNING INSTANT-ON TORCHES PLASMA ARC CAN CAUSE INJURY AND BURNS
		The plasma arc comes on immediately when the torch is activated. Make sure the power is OFF before changing the consumables.

A complete set of shielded consumables is shipped with the T45m machine torch. In addition, an ohmic-sensing retaining cap is available for use with the T45m shielded consumables. Unshielded consumables and the T30v (Powermax30) 30 A consumables are also available for use with the T45m.

How to use the cut charts

The following sections provide illustrations of the consumable sets and cut charts for each set. Maximum cut speeds are the fastest speeds possible to cut material without regard to cut quality. Recommended cut speeds are a good starting point for finding the best quality cut (best angle, least dross, and best cut-surface finish). You will need to adjust the speeds for your application and your table to obtain the desired cut quality.

T45m shielded consumables

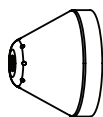

220673
Shield

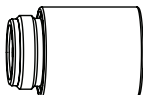

220713
Retaining cap

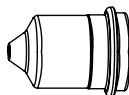

220671
Nozzle

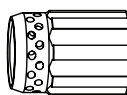

220670
Swirl ring

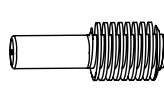

220669
Electrode

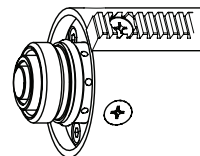

or

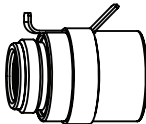

220719
Ohmic-sensing retaining cap

The cut charts for these consumables are shown on the next pages.

T45m shielded consumables

Mild steel
Metric

Air flowrate (lpm)	
Hot	151
Cold	165.2

					Recommended		Maximum					
Arc current (amps)	Material thickness (mm)	Torch-to-work distance (mm)	Initial pierce height		Pierce time delay (sec)	Cut Speed (mm/min)	Voltage (V)	Cut Speed (mm/min)	Voltage (V)			
30	0.5	1.5	3.8 mm	250%	0.0	9150	117	10160*	118			
	0.8					8650	116	10160*	117			
	0.9					8100	115	10160*	117			
	1.5				0.2	5650	111	7100	115			
45	0.9	1.5	3.8 mm	250%	0.0	9652	115	10160*	112			
	1.5					8890	116	10160*	115			
	1.9				0.1	7100	117	9144	115			
	2.7				0.3	4800	117	6096	115			
	3.4				0.4	3550	117	4445	115			
	4.8				0.5	2150	118	2794	115			
	6.4				0.6	1500	120	1905	116			
	9.5				0.9	810	122	1016	116			
	12.7				Edge start recommended				510	132	635	125
	15.9								280	138	356	127
	19.1								200	140	254	131
	25.4								100	146	127	142

*Maximum cut speed is limited by the test table's maximum speed (10160 mm/min).

TORCH SETUP

T45m shielded consumables

Mild Steel
English

Air flowrate (scfh)	
Hot	320
Cold	360

					Recommended		Maximum					
Arc current (amps)	Material thickness	Torch-to-work distance	Initial pierce height		Pierce time delay (sec)	Cut Speed (ipm)	Voltage (V)	Cut Speed (ipm)	Voltage (V)			
30	0.018 in (26 Ga)	0.06 in	0.15 in	250%	0.0	360	117	400*	118			
	0.030 in (22 Ga)					340	116	400*	117			
	0.036 in (20 Ga)					320	115	400*	117			
	0.060 in (16 Ga)				0.2	225	111	280	115			
45	0.036 in (20 Ga)	0.06 in	0.15 in	250%	0.0	380	115	400*	112			
	0.060 in (16 Ga)					350	116	400*	115			
	0.075 in (14 Ga)					0.1	280	117	360	115		
	0.105 in (12 Ga)					0.3	190	117	240	115		
	0.135 in (10 Ga)					0.4	140	117	175	115		
	0.188 in (3/16 in)					0.5	85	118	110	115		
	0.250 in (1/4 in)					0.6	60	120	75	116		
	0.375 in (3/8 in)					0.9	32	122	40	116		
	0.500 in (1/2 in)				Edge start recommended				20	132	25	125
	0.625 in (5/8 in)								11	138	14	127
	0.750 in (3/4 in)								8	140	10	131
	1.000 in (1 in)								4	146	5	142

*Maximum cut speed is limited by the test table's maximum speed (400 ipm).

T45m shielded consumables

Stainless steel
Metric

Air flowrate (lpm)	
Hot	151
Cold	165.2

					Recommended		Maximum				
Arc current (amps)	Material thickness (mm)	Torch-to-work distance (mm)	Initial pierce height		Pierce time delay (sec)	Cut Speed (mm/min)	Voltage (V)	Cut Speed (mm/min)	Voltage (V)		
30	0.5	1.5	3.8 mm	250%	0.0	9150	119	10160*	123		
	0.8					8650	117	10160*	121		
	0.9					8100	115	10160*	119		
	1.5				0.2	3750	113	4700	118		
45	0.9	1.5	3.8 mm	250%	0.0	7600	112	10160*	109		
	1.5					8100	112	10160*	125		
	1.9				0.1	7100	118	9144	115		
	2.7				0.3	4050	118	5080	116		
	3.4				0.4	3050	121	3810	118		
	4.8				0.5	1780	122	2159	118		
	6.4				0.6	1100	124	1397	120		
	9.5				0.8	760	126	813	121		
	12.7				Edge start recommended			350	132	457	128
	19.1							175	136	229	131

*Maximum cut speed is limited by the test able's maximum speed (10160 mm/min).

TORCH SETUP

T45m shielded consumables

Stainless steel
English

Air flowrate (scfh)	
Hot	320
Cold	360

					Recommended		Maximum				
Arc current (amps)	Material thickness	Torch-to-work distance (in)	Initial pierce height		Pierce time delay (sec)	Cut Speed (ipm)	Voltage (V)	Cut Speed (ipm)	Voltage (V)		
30	0.018 in (26 Ga)	0.06	0.15 in	250%	0.0	360	117	400*	123		
	0.030 in (22 Ga)					340	116	400*	121		
	0.036 in (20 Ga)					320	115	400*	119		
	0.060 in (16 Ga)				0.2	145	111	185	118		
45	0.036 in (20 Ga)	0.06	0.15 in	250%	0.0	300	115	400*	109		
	0.060 in (16 Ga)					320	116	400*	125		
	0.075 in (14 Ga)				0.1	280	117	360	115		
	0.105 in (12 Ga)				0.3	160	117	200	116		
	0.135 in (10 Ga)				0.4	120	117	150	118		
	0.188 in (3/16 in)				0.5	70	118	85	118		
	0.250 in (1/4 in)				0.6	44	120	55	120		
	0.375 in (3/8 in)				0.8	30	122	32	121		
	0.500 in (1/2 in)				Edge start recommended			14	132	18	128
	0.750 in (3/4 in)				Edge start recommended			7	140	9	131

*Maximum cut speed is limited by the test table's maximum speed (400 ipm).

T45m shielded consumables

Aluminum
Metric

Air flowrate (lpm)	
Hot	151
Cold	165.2

					Recommended		Maximum					
Arc current (amps)	Material thickness (mm)	Torch-to-work distance (mm)	Initial pierce height		Pierce time delay (sec)	Cut Speed (mm/min)	Voltage (V)	Cut Speed (mm/min)	Voltage (V)			
30	1.2	1.5	3.8 mm	250%	0.0	9150	117	10160*	120			
	0.2				8650	118	10160*	121				
					5450	118	6860	121				
45	1.5	1.5	3.8 mm	250%	0.0	9150	116	10160*	114			
	8650					117	10160	116				
	7100					120	9144	119				
					0.1	5600	122	7112	120			
					0.2	2550	123	3302	120			
					0.3	2050	123	2540	120			
					0.5	840	130	1067	125			
					Edge start recommended				510	134	635	130
									200	143	254	138

*Maximum cut speed is limited by the test table's maximum speed (10160 mm/min).

TORCH SETUP

T45m shielded consumables

Aluminum
English

Air flowrate (scfh)	
Hot	320
Cold	360

					Recommended		Maximum							
Arc current (amps)	Material thickness	Torch-to-work distance (in)	Initial pierce height		Pierce time delay (sec)	Cut Speed (ipm)	Voltage (V)	Cut Speed (ipm)	Voltage (V)					
30	0.018 in (26 Ga)	0.06	0.15 in	250%	0.0	360	117	400*	120					
	0.2				340	118	400*	121						
					215	118	270	121						
45	0.060 in (16 Ga)	0.06	0.15 in	250%	0.0	360	116	400*	114					
	340					117	400*	116						
	280					120	360	119						
	0.135 in (10 Ga)				0.06	0.15 in	250%	0.1	220	122	280	120		
	0.188 in (3/16 in)							0.2	100	123	130	120		
	0.250 in (1/4 in)							0.3	80	123	100	120		
	0.375 in (3/8 in)							0.5	33	130	42	125		
	0.500 in (1/2 in)							Edge start recommended			20	134	25	130
	0.750 in (3/4 in)							Edge start recommended			8	143	10	138

*Maximum cut speed is limited by the test table's maximum speed (400 ipm).

T45m unshielded consumables

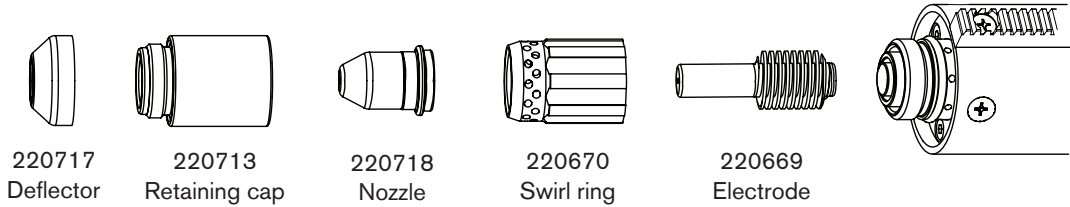

**Mild steel
Metric**

Air flowrate (lpm)	
Hot	151
Cold	165.2

					Recommended		Maximum					
Arc current (amps)	Material thickness (mm)	Torch-to-work distance (mm)	Initial pierce height		Pierce time delay (sec)	Cut Speed (mm/min)	Voltage (V)	Cut Speed (mm/min)	Voltage (V)			
30	0.5	2.0	5.0 mm	250%	0.0	9150	118	10160*	114			
	0.8					8650	118	10160*	116			
	0.9					8100	117	10160*	120			
	1.5				0.2	5800	113	7250	119			
45	0.9	2.0	5.0 mm	250%	0.0	9650	118	10160*	110			
	1.5					8900	114	10160*	113			
	1.9					6100	114	7620	114			
	2.7				0.3	4450	116	5588	114			
	3.4				0.4	3400	118	4318	116			
	4.8				0.4	2150	118	2794	116			
	6.4				0.5	1500	118	1905	118			
	9.5				0.7	810	120	1016	118			
	12.7				Edge start recommended				510	130	635	124
	15.9								280	132	356	126
	19.1								200	138	254	132
	25.4								100	145	127	140

*Maximum cut speed is limited by the test table's maximum speed (10160 mm/min).

TORCH SETUP

T45m unshielded consumables

Mild Steel
English

Air flowrate (scfh)	
Hot	320
Cold	360

					Recommended		Maximum					
Arc current (amps)	Material thickness	Torch-to-work distance (in)	Initial pierce height		Pierce time delay (sec)	Cut Speed (ipm)	Voltage (V)	Cut Speed (ipm)	Voltage (V)			
30	0.018 in (26 Ga)	0.08	0.2 in	250%	0.0	360	118	400*	114			
	0.030 in (22 Ga)					340	118	400*	116			
	0.036 in (20 Ga)					320	117	400*	120			
	0.060 in (16 Ga)				0.2	225	113	285	119			
45	0.036 in (20 Ga)	0.08	0.2 in	250%	0.0	380	118	400*	110			
	0.060 in (16 Ga)					350	114	400*	113			
	0.075 in (14 Ga)					240	114	300	114			
	0.105 in (12 Ga)				0.3	175	116	220	114			
	0.135 in (10 Ga)				0.4	135	118	170	116			
	0.188 in (3/16 in)				0.4	85	118	110	116			
	0.250 in (1/4 in)				0.5	60	118	75	118			
	0.375 in (3/8 in)				0.7	32	120	40	118			
	0.500 in (1/2 in)				Edge start recommended				20	130	25	124
	0.625 in (5/8 in)								11	132	14	126
	0.750 in (3/4 in)								8	138	10	132
	1.000 in (1 in)								4	145	5	140

*Maximum cut speed is limited by the test table's maximum speed (400 ipm).

T45m unshielded consumables

Stainless steel
Metric

Air flowrate (lpm)	
Hot	151
Cold	165.2

					Recommended		Maximum			
Arc current (amps)	Material thickness (mm)	Torch-to-work distance (mm)	Initial pierce height		Pierce time delay (sec)	Cut Speed (mm/min)	Voltage (V)	Cut Speed (mm/min)	Voltage (V)	
30	0.5	2.0	5.0 mm	250%	0.0	9144	113	10160*	125	
	0.8					8128	115	10160*	128	
	0.9					7000	114	9000	125	
	1.5				0.2	3650	112	4800	118	
45	0.9	2.0	5.0 mm	250%	0.0	8900	112	10160*	110	
	1.5					8100	115	10160*	113	
	1.9				0.1	7112	116	9144	114	
	2.7				0.3	4100	118	5080	116	
	3.4				0.4	2800	120	3556	118	
	4.8				0.5	1650	120	2032	118	
	6.4				0.6	1010	121	1270	118	
	9.5				0.8	610	125	762	120	
	12.7				Edge start recommended		355	130	457	126
	19.1						175	133	229	138

*Maximum cut speed is limited by the test table's maximum speed (10160 mm/min).

TORCH SETUP

T45m unshielded consumables

Stainless steel
English

Air flowrate (scfh)	
Hot	320
Cold	350

					Recommended		Maximum				
Arc current (amps)	Material thickness	Torch-to-work distance (in)	Initial pierce height		Pierce time delay (sec)	Cut Speed (ipm)	Voltage (V)	Cut Speed (ipm)	Voltage (V)		
30	0.018 in (26 Ga)	0.08	0.2 in	250%	0.0	360	113	400*	125		
	0.030 in (22 Ga)					320	115	400*	128		
	0.036 in (20 Ga)					275	114	345	125		
	0.060 in (16 Ga)				0.2	145	112	180	118		
45	0.036 in (20 Ga)	0.08	0.2 in	250%	0.0	350	112	400*	110		
	0.060 in (16 Ga)					320	115	400*	113		
	0.075 in (14 Ga)				0.1	280	116	360	114		
	0.105 in (12 Ga)				0.3	160	118	200	116		
	0.135 in (10 Ga)				0.4	110	120	140	118		
	0.188 in (3/16 in)				0.5	64	120	80	118		
	0.250 in (1/4 in)				0.6	40	121	50	118		
	0.375 in (3/8 in)				0.8	24	125	30	120		
	0.500 in (1/2 in)				Edge start recommended			14	130	18	126
	0.750 in (3/4 in)							7	133	9	138

*Maximum cut speed is limited by the test table's maximum speed (400 ipm).

T45m unshielded consumables

Aluminum
Metric

Air flowrate (lpm)	
Hot	151
Cold	165.2

					Recommended		Maximum			
Arc current (amps)	Material thickness (mm)	Torch-to-work distance (mm)	Initial pierce height		Pierce time delay (sec)	Cut Speed (mm/min)	Voltage (V)	Cut Speed (mm/min)	Voltage (V)	
30	1.2	2.0	5.0 mm	250%	0.0	8900	122	10160*	121	
	1.5				0.1	8100	120	10160*	118	
	1.9				0.2	5700	121	7100	119	
45	1.5	1.5	5.0 mm	250%	0.0	8900	120	10160*	116	
	1.9					8100	120	10160*	116	
	2.7					7200	122	9144	118	
	3.4				0.1	5500	123	6858	118	
	4.8				0.3	2540	123	3175	118	
	6.4				0.3	1820	128	2286	124	
	9.5				0.5	710	130	914	124	
	12.7				Edge start recommended		510	131	635	125
	19.1						200	148	254	143

*Maximum cut speed is limited by the test table's maximum speed (10160 mm/min).

TORCH SETUP

T45m unshielded consumables

Aluminum
English

Air flowrate (scfh)	
Hot	320
Cold	360

					Recommended		Maximum			
Arc current (amps)	Material thickness	Torch-to-work distance (in)	Initial pierce height		Pierce time delay (sec)	Cut Speed (ipm)	Voltage (V)	Cut Speed (ipm)	Voltage (V)	
30	0.018 in (26 Ga)	0.08	0.20 in	250%	0.0	350	122	400*	121	
	0.060 in (16 Ga)				0.1	320	120	400*	118	
	0.075 in (14 Ga)				0.2	225	121	280	119	
45	0.060 in (16 Ga)	0.08	0.20 in	250%	0.0	350	120	400*	116	
	0.075 in (14 Ga)					320	120	400*	116	
	0.105 in (12 Ga)					285	122	360	118	
	0.135 in (10 Ga)				0.1	215	123	270	118	
	0.188 in (3/16 in)				0.3	100	123	125	118	
	0.250 in (1/4 in)				0.3	72	128	90	124	
	0.375 in (3/8 in)				0.5	28	130	36	124	
	0.500 in (1/2 in)				Edge start recommended		20	131	25	125
	0.750 in (3/4 in)						8	148	10	143

*Maximum cut speed is limited by the test table's maximum speed (400 ipm or 10160 mm/min).

T30v (Powermax30) 30 A consumables

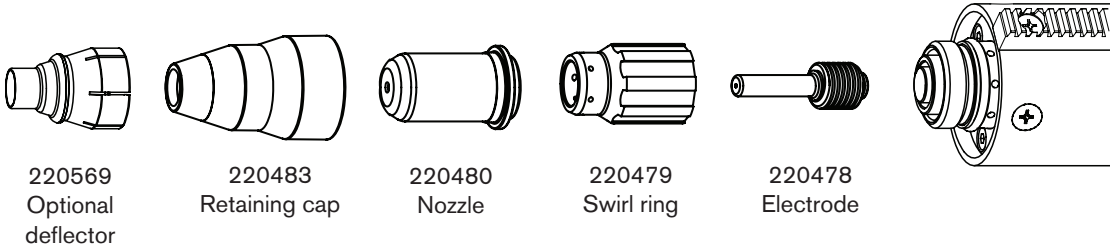

**Mild steel
Metric**

Air flowrate (lpm)	
Hot	131.2
Cold	146.3

Arc current (amps)	Material thickness (mm)	Torch-to-work distance (mm)	Initial pierce height		Pierce time delay (sec)	Recommended		Maximum		
						Cut Speed (mm/min)	Voltage (V)	Cut Speed (mm/min)	Voltage (V)	
30	0.5	0.5	2.5 mm	500%	0.0	8900	105	10160*	98	
	0.8					8100	102	10160*	103	
	0.9					7100	101	8900	100	
	1.5				0.2	4450	97	5600	100	
	1.9					0.4	3050	98	3800	97
	2.7						2050	96	2550	96
	3.4						1270	100	1650	101

*Maximum cut speed is limited by the test table's maximum speed (10160 mm/min).

TORCH SETUP

T30v (Powermax30) 30 A consumables

Mild steel

English

Air flowrate (scfh)	
Hot	280
Cold	310

Arc current (amps)	Material thickness (in)	Torch-to-work distance (in)	Initial pierce height		Pierce time delay (sec)	Recommended		Maximum				
						Cut Speed (ipm)	Voltage (V)	Cut Speed (ipm)	Voltage (V)			
30	0.018 (26 Ga)	0.02	0.1 in	500%	0.0	350	105	400*	98			
	0.030 (22 Ga)					320	102	400*	103			
	0.036 (20 Ga)					280	101	350	100			
	0.060 (16 Ga)				0.02	0.1 in	500%	0.2	175	97	220	100
	0.075 (14 Ga)							0.4	120	98	150	97
	0.105 (12 Ga)								80	96	100	96
	0.135 (10 Ga)								50	100	65	101

*Maximum cut speed is limited by the test table's maximum speed (400 ipm).

T30v (Powermax30) 30 A consumables

Stainless steel
Metric

Air flowrate (lpm)	
Hot	131.2
Cold	146.3

					Recommended		Maximum			
Arc current (amps)	Material thickness (mm)	Torch-to-work distance (mm)	Initial pierce height		Pierce time delay (sec)	Cut Speed (mm/min)	Voltage (V)	Cut Speed (mm/min)	Voltage (V)	
30	0.5	0.5	2.5 mm	500%	0.0	8900	103	10160*	102	
	0.8					8100	98	10160*	100	
	0.9					7600	97	6850	98	
	1.5				0.2	3800	99	4800	98	
	1.9					0.4	2800	101	3450	97
	2.7						1500	101	1900	98
	3.4						1150	102	1400	97

*Maximum cut speed is limited by the test table's maximum speed (10160 mm/min).

TORCH SETUP

T30v (Powermax30) 30 A consumables

Stainless steel
English

Air flowrate (scfh)	
Hot	280
Cold	310

					Recommended		Maximum					
Arc current (amps)	Material thickness (in)	Torch-to-work distance (in)	Initial pierce height		Pierce time delay (sec)	Cut Speed (ipm)	Voltage (V)	Cut Speed (ipm)	Voltage (V)			
30	0.018 (26 Ga)	0.02	0.1 in	500%	0.0	350	103	400*	102			
	0.030 (22 Ga)					320	98	400*	100			
	0.036 (20 Ga)					300	97	380	98			
	0.060 (16 Ga)				0.02	0.1 in	500%	0.2	150	99	190	98
	0.075 (14 Ga)							0.4	110	101	135	97
	0.105 (12 Ga)								60	101	75	98
	0.135 (10 Ga)								45	102	55	97

*Maximum cut speed is limited by the test table's maximum speed (400 ipm).

T30v (Powermax30) 30 A consumables

Aluminum
Metric

Air flowrate (lpm)	
Hot	131.2
Cold	146.3

					Recommended		Maximum		
Arc current (amps)	Material thickness (mm)	Torch-to-work distance (mm)	Initial pierce height		Pierce time delay (sec)	Cut Speed (mm/min)	Voltage (V)	Cut Speed (mm/min)	Voltage (V)
30	0.5	0.5	2.5 mm	500%	0.0	8100	107	10160*	105
	0.8					6100	104	7650	103
	0.9					4800	104	6100	103
	1.5				0.2	3700	103	4550	103
	1.9					2400	101	3050	101

Aluminum
English

Air flowrate (lpm)	
Hot	131.2
Cold	146.3

					Recommended		Maximum		
Arc current (amps)	Material thickness (in)	Torch-to-work distance (in)	Initial pierce height		Pierce time delay (sec)	Cut Speed (ipm)	Voltage (V)	Cut Speed (ipm)	Voltage (V)
30	0.036 (20 Ga)	0.02	0.10 in	500%	0.0	320	107	400*	105
	0.060 (16 Ga)					240	104	300	103
	0.075 (14 Ga)					190	104	240	103
	0.105 (12 Ga)				0.2	145	103	180	103
	0.135 (10 Ga)					95	101	120	101

*Maximum cut speed is limited by the test table's maximum speed (400 ipm or 10160 mm/min).

TORCH SETUP

Align the torch

Mount the machine torch perpendicular to the workpiece in order to get a vertical cut. Use a square to align the torch at 0° and 90°.

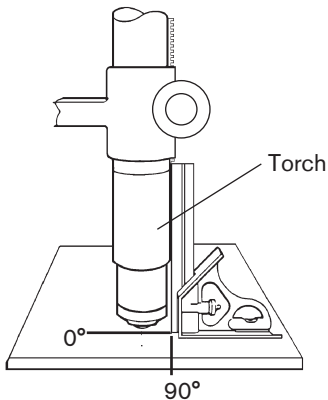

Connect the remote-start pendant

Configurations of a Powermax45 with a T45m also can include a 25-foot (7.62 m), 50-foot (15.24 m), or 75-foot (22.86 m) remote-start pendant. To use the Hypertherm remote-start pendant, plug it into the receptacle on the rear of the power supply.

Note: The remote-start pendant is for use only with a machine torch. It will not operate if a handheld torch is installed.

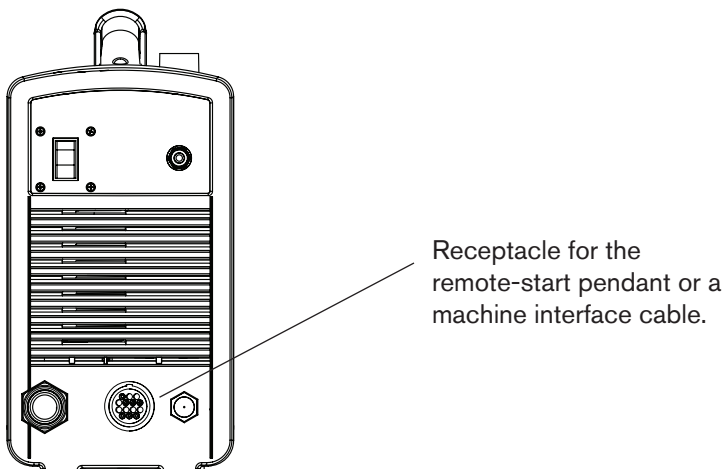

Connect a machine interface cable

The Powermax45 is equipped with a factory-installed voltage divider that is designed to be safely connected without tools. The built-in voltage divider provides a 50:1 arc voltage. A receptacle on the rear of the power supply provides access to the 50:1 arc voltage and signals for arc transfer and plasma start.

Caution: The factory-installed internal voltage divider provides a maximum of 7 V under open circuit conditions. This is an impedance-protected functional extra low voltage (ELV) output to prevent shock, energy, and fire under normal conditions at the machine interface receptacle and under single fault conditions with the machine interface wiring. The voltage divider is not fault tolerant and ELV outputs do not comply with safety extra low voltage (SELV) requirements for direct connection to computer products.



Hypertherm offers several choices of machine interface cables for the Powermax45:

- To use the built-in voltage divider that provides a 50:1 arc voltage in addition to signals for arc transfer and start plasma:
 - Use part number 228350 (25 ft, 7.62 m) or 228351 (50 ft, 15.24 m) for wires terminated with spade connectors (example shown below).
 - Use part number 123896 (50 ft, 15.24 m) for a cable terminated with a D-sub connector. (Compatible with Hypertherm's Edge Ti and Sensor PHC products.)
- To use signals for arc transfer and start plasma only, use either part number 023206 (25 ft, 7.63 m) or part number 023279 (50 ft, 15.24 m). These cables have spade connectors as shown here:

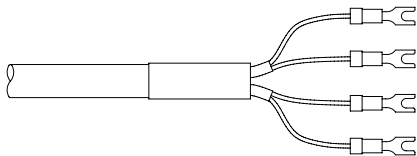

Note: The cover on the machine interface receptacle prevents dust and moisture from damaging the receptacle when not in use. This cover should be replaced if damaged or lost (part number 127204).

See Section 6, *Parts*, for more information.

TORCH SETUP

Installation of the machine interface cable must be performed by a qualified service technician. To install a machine interface cable:

1. Turn OFF the power and disconnect the power cord.
2. Remove the machine interface receptacle's cover from the rear of the power supply.
3. Connect the Hypertherm machine interface cable to the power supply.
4. If you are using a cable with a D-sub connector on the other end, plug it into the appropriate pin connector on the torch height controller or CNC. Secure it with the screws on the D-sub connector.

If you are using a cable with wires and spade connectors on the other end, terminate the machine interface cable inside the electrical enclosure of listed and certified torch height controllers or CNC controllers to prevent operator access to the connections after installation. Verify that the connections are correct and that all live parts are enclosed and protected before operating the equipment.

Note: The integration of Hypertherm equipment and customer-supplied equipment including interconnecting cords and cables, if not listed and certified as a system, is subject to inspection by local authorities at the final installation site.

The connector sockets for each type of signal available through the machine interface cable are shown below. The table on the next page provides details about each signal type.

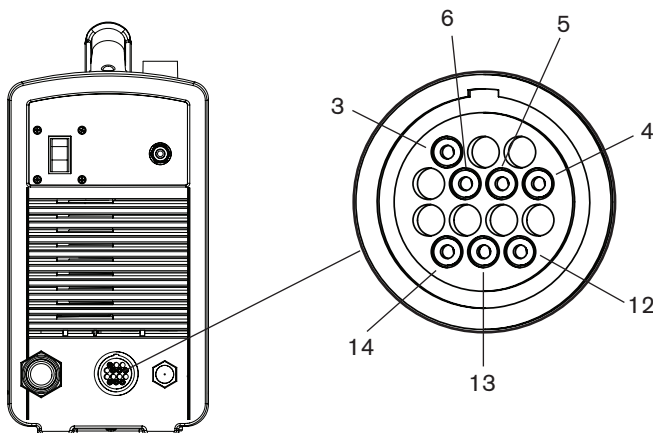



Refer to the following table when connecting the Powermax45 to a torch height controller or CNC controller with a machine interface cable.

Signal	Type	Notes	Connector sockets	Cable wires
Start (start plasma)	Input	Normally open. 18 VDC open circuit voltage at START terminals. Requires dry contact closure to activate.	3, 4	Green, black
Transfer (start machine motion)	Output	Normally open. Dry contact closure when the arc transfers. 120 VAC/1 A maximum at the machine interface relay or switching device (supplied by the customer).	12, 14	Red, black
Ground	Ground		13	
Voltage divider	Output	Divided arc signal of 20:1, 21.1:1, 30:1, 40:1, 50:1 (provides a maximum of 18 V).	5, 6	Black, white

Accessing raw arc voltage

If you should need to access raw arc voltage, contact your Hypertherm distributor or authorized Hypertherm repair facility for assistance.

		<p>WARNING: HIGH VOLTAGE AND CURRENT</p>
<p>Connecting directly to the plasma circuit for access to raw arc voltage increases the risk of shock hazard, energy hazard, and fire hazard in the event of a single fault. The output voltage and the output current of the circuit are specified on the data plate.</p>		

TORCH SETUP

Connect the torch lead

The Powermax45 is equipped with FastConnect™, a quick-disconnect system for connecting and disconnecting the handheld and machine torches. When connecting or disconnecting a torch, first turn OFF the system. To connect either torch, push the connector into the receptacle on the front of the power supply.

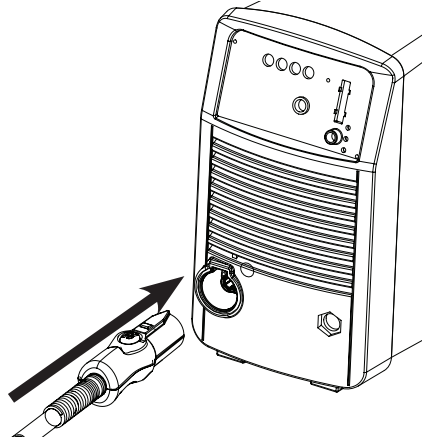

To remove the torch, press the red button on the connector and pull the connector out of the receptacle.

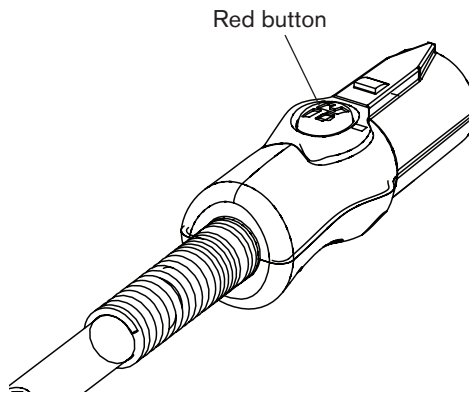

Section 4

Operation

In this section:

Controls and indicators	4-2
Front controls and LEDs	4-2
Rear controls	4-3
Operate the Powermax45	4-4
Connect the electrical power and gas supply	4-4
Turn ON the system	4-4
Set the mode switch	4-5
Adjust the gas pressure	4-5
Check the indicator LEDs	4-6
Attach the work clamp	4-7
Understand duty-cycle limitations	4-7
How to use the hand torch	4-8
Operate the safety trigger	4-8
Hand torch cutting hints	4-9
Start a cut from the edge of the workpiece	4-10
Pierce a workpiece	4-11
Gouge a workpiece	4-12
Common hand-cutting faults	4-14
How to use the machine torch	4-15
Ensure the torch and table are set up correctly	4-15
Understand and optimize cut quality	4-15
To pierce a workpiece using the machine torch	4-17
Common machine-cutting faults	4-18

Controls and indicators

The Powermax45 has an ON/OFF switch, an amperage adjustment knob, a pressure regulator knob, a mode switch, 4 indicator LEDs, and a gas pressure LED, which are described below.

Front controls and LEDs

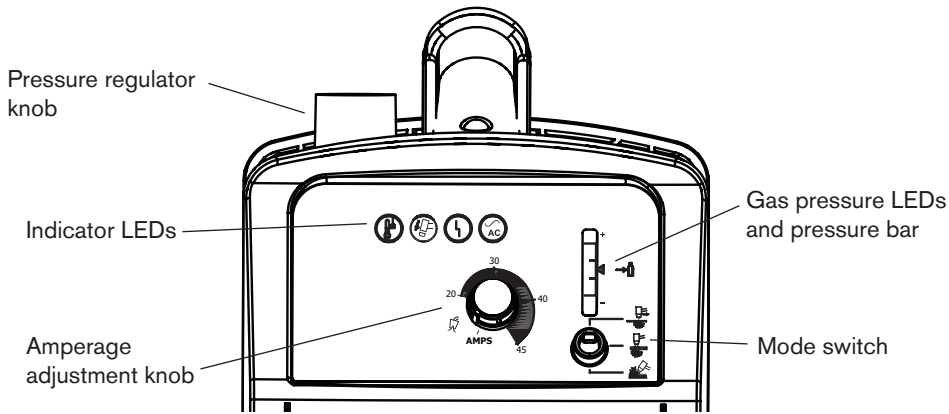

Temperature LED (yellow)

When illuminated, this LED indicates that the power supply's temperature is outside the acceptable range.



Torch cap sensor LED (yellow)

When illuminated, this LED indicates that the consumables are loose, improperly installed, or missing. For information on the possible fault conditions, see *Basic troubleshooting* in Section 5. If this LED illuminates, the power must be turned OFF, the consumables installed properly, and the system turned ON again to reset the LED.



Fault LED (yellow)

When illuminated, this LED indicates that there is a fault with the power supply. Some fault conditions will cause one or more of the LEDs to blink. For information on what these fault conditions are and how to correct them, see *Basic troubleshooting* in Section 5.



Power ON LED (green)

When illuminated, this LED indicates that the power switch has been set to I (ON) and that the safety interlocks are satisfied.

Gas pressure LED and pressure bar (green or yellow)

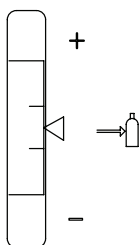

When the LED indicator in the pressure bar illuminates green and is centered in the vertical bar, the gas pressure is set correctly for the mode of cutting selected with the mode switch. If the pressure is too high for the selected mode, the indicator in the pressure bar will be above the mid-point of the bar. If it is too low, the indicator will be below the mid-point. At the highest and lowest points on the bar, the indicator will illuminate yellow.

If the indicator is at the lowest part of the bar and flashes, then the gas pressure is less than the minimum required pressure.

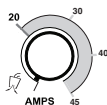

Amperage adjustment knob

Set this knob to the gas-test position (fully counter-clockwise) before adjusting the gas pressure with the pressure regulator knob on the top of the power supply. Once the gas pressure is set, turn the knob clockwise to set the output amperage. The torch will not fire when the knob is in the gas-test position.

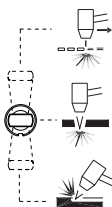

Mode switch and LEDs

The mode switch can be set in one of three positions:

- Continuous pilot arc to cut expanded metal or grate (top).
- Non-continuous pilot arc to cut metal plate (middle).
- Gouging (bottom).

After you change the mode switch, verify that the gas pressure is still set correctly. Different modes of cutting require different pressure settings.

Rear controls

CSA/230 V CE



400 V CE

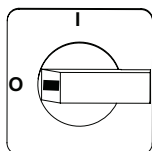

ON (I)/OFF (O) power switch

Activates the power supply and its control circuits.

OPERATION

Operate the Powermax45

Follow the steps below to begin cutting or gouging with the Powermax45.

Connect the electrical power and gas supply

Plug in the power cord and connect the gas supply line. For more information about the electrical requirements and the gas supply requirements of the Powermax45, see Section 2, *Power supply setup*.

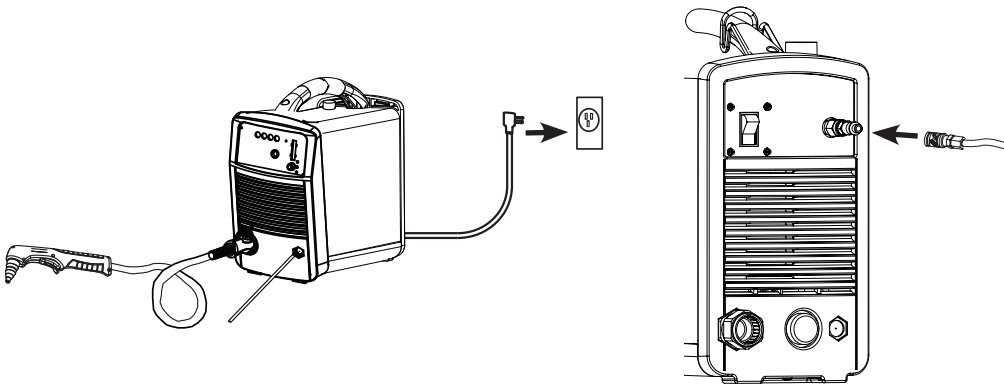

Turn ON the system

Set the ON/OFF switch to the ON (I) position.

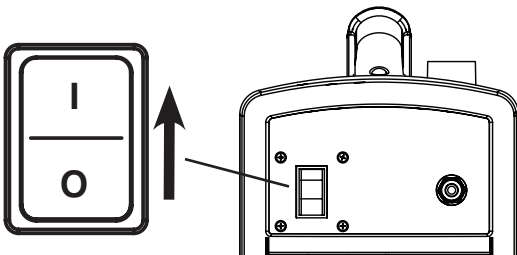

CSA/230 V CE

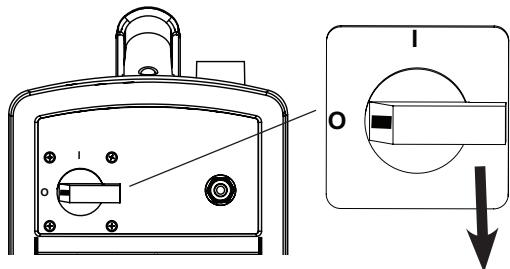

400 V CE

Set the mode switch

Use the mode switch to select the type of work you will be doing:

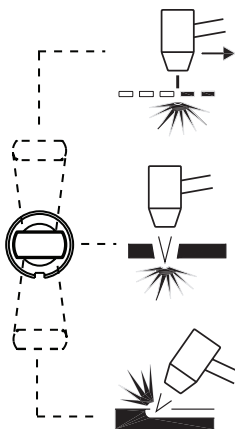

To cut expanded metal or grate cutting (top position). Use this setting to cut metal with holes in it or for any job that requires a continuous pilot arc. Leaving the mode switch on this setting to cut standard metal plate will reduce consumable life.

To cut metal plate (middle position). Use this setting to cut metal up to 1-inch (25.4 mm) thick or pierce metal up to 1/2-inch (12.7 mm) thick.

Gouging (bottom position). Use this setting to gouge metal. Leaving the mode switch on this setting while cutting results in poor cut quality.

Adjust the gas pressure

Look at the gas pressure LED. If it illuminates green in the center of the pressure bar, the incoming gas pressure is correct for the mode you have selected. If the LED illuminates yellow, either above or below the center, the gas pressure needs to be adjusted.

To adjust the pressure:

1. Turn the amperage knob counter-clockwise to the gas-test position as show below.

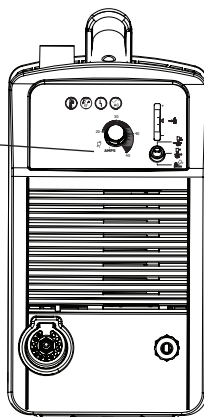
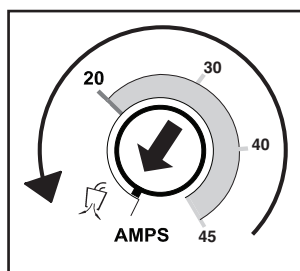

OPERATION

2. With the amperage knob in the gas test position, pull up on the pressure regulator knob on top of the system to unlock it.

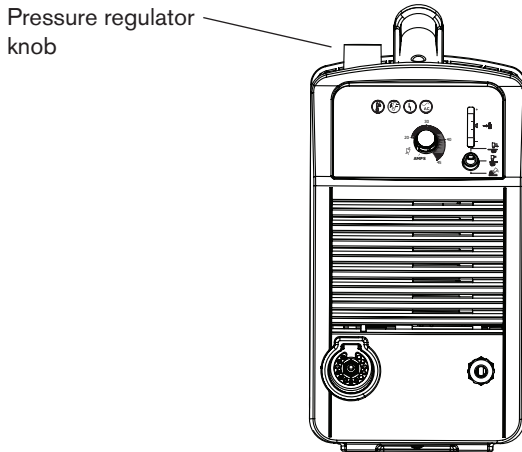

3. Turn the pressure regulator knob until the gas pressure LED illuminates a green in the center of the pressure bar.
4. Press down on the pressure regulator knob to lock it in position.
5. Turn the amperage knob to the cutting current appropriate for your application. If you are using T30v (Powermax30) 30 A consumables, do not set the amperage knob above 30 A.

Check the indicator LEDs

Verify that the green power ON LED on the front of the power supply is illuminated, that the gas pressure LED shows a green bar in the center of the gauge, and that none of the other LEDs are illuminated or blinking. If the temperature, torch cap sensor, or fault LEDs are illuminated or blinking, or if the power ON LED blinks, correct the fault condition before continuing. See *Basic troubleshooting*, in Section 5, for more information.

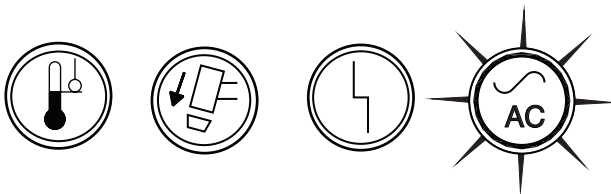

Attach the work clamp

The work clamp must be attached to the workpiece while you are cutting.

Note: If you are using the Powermax45 with a cutting table, you can ground it through the table instead of using the work clamp. See your table manufacturer's instructions for more information.

- Ensure that the work clamp and the workpiece make good metal-to-metal contact.
- For the best cut quality, attach the work clamp as close as possible to the area being cut.
- **Do not attach the work clamp to the portion of the workpiece to be cut away.**

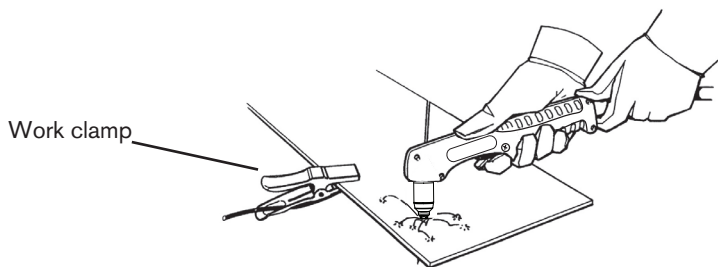

When the power ON LED is illuminated, none of the other LEDs are illuminated or blinking, the gas pressure LED indicates pressure is in the correct range, the amperage knob is set, and the work clamp is attached, then the system is ready for use.

Understand duty-cycle limitations



The duty cycle is the amount of time, in minutes, that a plasma arc can remain on within a 10-minute period when operating at an ambient temperature of 104° F (40° C). With a Powermax45:

- At 45 A, the arc can remain on for 5 minutes out of 10 minutes without causing the unit to overheat (50% duty cycle).
- At 41 A, the arc can remain on for 6 minutes out of 10 (60%)
- At 32 A, the arc can remain on for 10 minutes out of 10 (100%).

If the power supply overheats because the duty cycle is exceeded, the temperature LED will illuminate, the arc will shut off, and the cooling fan will continue to run. Wait for the temperature LED to extinguish before you resume cutting.

The next section explains how to operate the hand torch. To operate the machine torch, see *Use the machine torch*, later in this section.

How to use the hand torch

		WARNING INSTANT-ON TORCHES PLASMA ARC CAN CAUSE INJURY AND BURNS
<p>Plasma arc comes on immediately when the torch trigger is activated. The plasma arc will cut quickly through gloves and skin.</p> <ul style="list-style-type: none">▪ Keep away from the torch tip.▪ Do not hold the workpiece and keep your hands clear of the cutting path.▪ Never point the torch toward yourself or others.		

Operate the safety trigger

The T45v is equipped with a safety trigger to prevent accidental firings. When you are ready to use the torch, flip the yellow safety trigger forward (toward the torch head) and press the red torch trigger as show below.

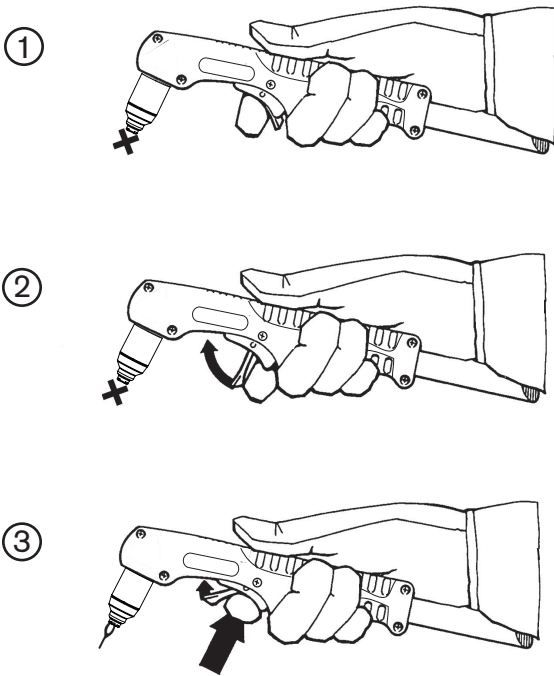

Hand torch cutting hints

- With shielded consumables, drag the nozzle lightly along the workpiece to maintain a steady cut. With unshielded consumables, maintain an approximate .08-inch (2 mm) distance between the tip of the torch and the workpiece. (This is between a 1/16th and 1/8th of an inch).
- While cutting, make sure that sparks exit from the bottom of the workpiece. The sparks should lag slightly behind the torch as you cut (15° — 30° angle from vertical).
- If sparks spray up from the workpiece, move the torch more slowly, or set the output current higher.

- Hold the torch nozzle perpendicular to the workpiece so that the nozzle is at a 90° angle to the cutting surface and watch the arc as it cuts along the line.

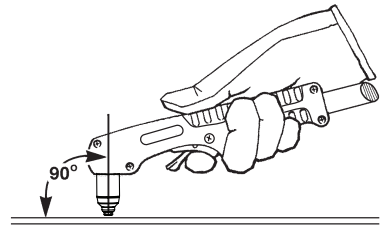

- If you fire the torch unnecessarily, you will shorten the life of the nozzle and electrode.
- Pulling, or dragging, the torch along the cut is easier than pushing it.
- For straight-line cuts, use a straight edge as a guide. To cut circles, use a template or a radius cutter attachment (a circle cutting guide). See Section 6, *Parts*, for part numbers for the Hypertherm plasma cutting guides for cutting circles and making bevel cuts.



OPERATION

Start a cut from the edge of the workpiece

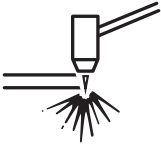

1. With the work clamp attached to the workpiece, hold the torch nozzle perpendicular (90°) to the edge of the workpiece. If you are using the shielded consumables, no torch-to-workpiece standoff is needed. With unshielded consumables, maintain an approximate .08-inch (2 mm) standoff.

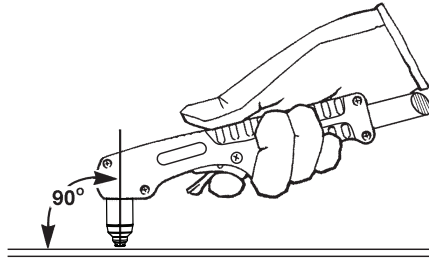

2. Press the torch's trigger to start the arc. Pause at the edge until the arc has cut completely through the workpiece.

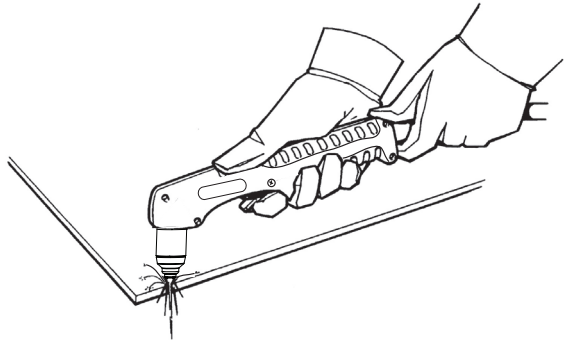

3. Drag the nozzle lightly across the workpiece to proceed with the cut. Maintain a steady, even pace.

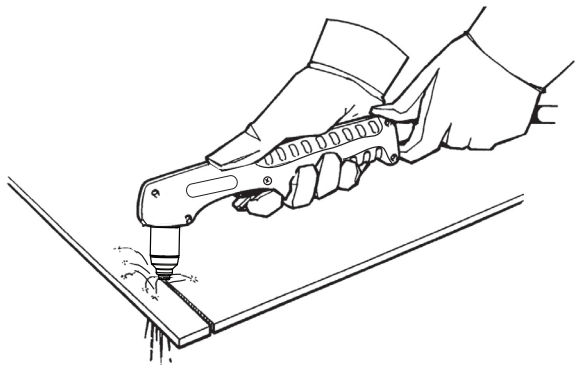

Pierce a workpiece

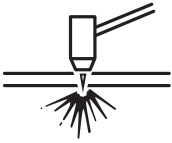
**WARNING**

SPARKS AND HOT METAL CAN INJURE EYES AND BURN SKIN.
When firing the torch at an angle, sparks and hot metal will spray out from the nozzle. Point the torch away from yourself and others.

1. With the work clamp attached to the workpiece, hold the torch at an approximate 30° angle to the workpiece with the nozzle within 1/16 inch (1.5 mm) of it before firing the torch.

2. Fire the torch while still at an angle to the workpiece, then slowly rotate the torch to a perpendicular (90°) position.

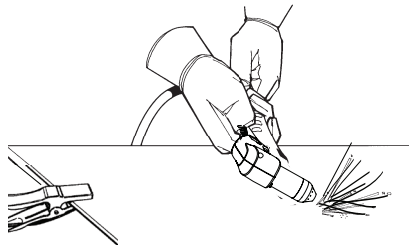

3. Hold the torch in place while continuing to press the trigger. When sparks exit below the workpiece, the arc has pierced the material.

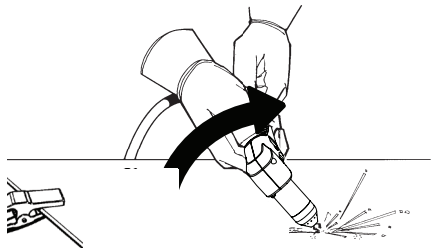

4. When the pierce is complete, drag the nozzle lightly along the workpiece to proceed with the cut.

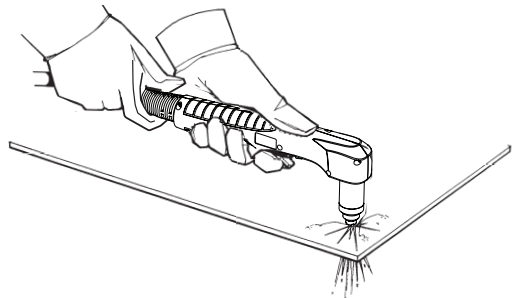

Gouge a workpiece



		WARNING
SPARKS AND HOT METAL CAN INJURE EYES AND BURN SKIN. When firing the torch at an angle, sparks and hot metal will spray out from the nozzle. Point the torch away from yourself and others.		

1. Hold the torch so that the nozzle is within 1/16 inch (1.5 mm) from the workpiece before firing the torch.

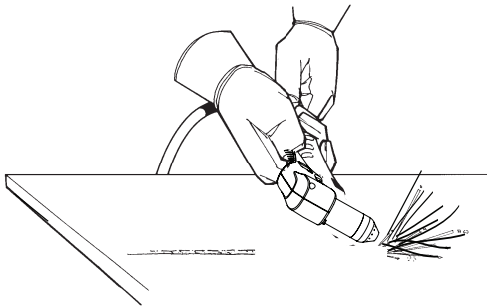

2. Hold the torch at a 45° angle to the workpiece with a small gap between the torch tip and the workpiece. Press the trigger to obtain a pilot arc. Transfer the arc to the work piece. Transfer the arc to the work piece.

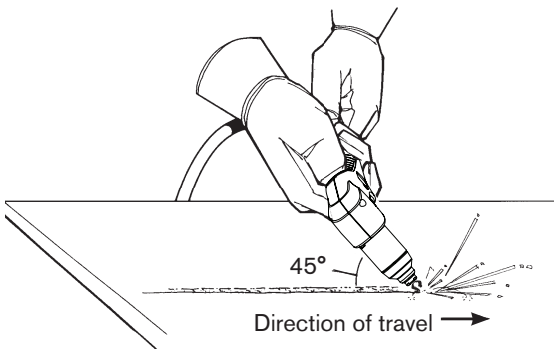

3. Maintain an approximate 45° angle to the workpiece as you feed into the gouge.

In other words, push the plasma arc in the direction of the gouge you want to create. Keep a small distance between the torch tip and the molten metal to avoid reducing consumable life or damaging the torch.

Changing the torch's angle changes the dimensions of the gouge.

Note: A heat shield is available for added hand and torch protection (part number 220049).

You can vary the depth of the gouge by varying the angle of the torch to the workpiece. The following tables show the gouging profile at 45° and 60° on mild steel and stainless steel.

Mild steel gouging profile

Torch angle	Speed	Width	Depth
45°	10 ipm (254 mm/min)	0.3051 in (7.75 mm)	0.0415 in (1.05 mm)
	20 ipm (508 mm/min)	0.2550 in (6.50 mm)	0.1158 in (2.94 mm)
	30 ipm (762 mm/min)	0.2267 in (5.76 mm)	0.0735 in (1.87 mm)
	40 ipm (1016 mm/min)	0.2087 in (5.30 mm)	0.0517 in (1.31 mm)
	50 ipm (1270 mm/min)	0.1863 in (4.73 mm)	0.0406 in (1.03 mm)
60°	10 ipm (254 mm/min)	0.3173 in (8.06 mm)	0.1645 in (4.18 mm)
	20 ipm (508 mm/min)	0.2423 in (6.15 mm)	0.0941 in (2.39 mm)
	30 ipm (762 mm/min)	0.2351 in (6.00 mm)	0.0546 in (1.39 mm)
	40 ipm (1016 mm/min)	0.2281 in (5.80 mm)	0.0476 in (1.21 mm)
	50 ipm (1270 mm/min)	0.1816 in (4.61 mm)	0.0289 in (0.73 mm)

Stainless steel gouging profile

Torch angle	Speed	Width	Depth
45°	10 ipm (254 mm/min)	0.2508 in (6.37 mm)	0.1200 in (3.05 mm)
	20 ipm (508 mm/min)	0.2258 in (5.74 mm)	0.0772 in (1.96 mm)
	30 ipm (762 mm/min)	0.2077 in (5.28 mm)	0.0428 in (1.09 mm)
	40 ipm (1016 mm/min)	0.1901 in (4.83 mm)	0.0680 in (1.73 mm)
	50 ipm (1270 mm/min)	0.1739 in (4.42 mm)	0.0580 in (1.47 mm)
60°	10 ipm (254 mm/min)	0.2580 in (6.55 mm)	0.2330 in (5.92 mm)
	20 ipm (508 mm/min)	0.2526 in (6.42 mm)	0.0792 in (2.01 mm)
	30 ipm (762 mm/min)	0.2329 in (5.92 mm)	0.0569 in (1.45 mm)
	40 ipm (1016 mm/min)	0.2110 in (5.36 mm)	0.0432 in (1.10 mm)
	50 ipm (1270 mm/min)	0.2003 in (5.09 mm)	0.0322 in (0.82 mm)

Common hand-cutting faults

The torch sputters and hisses, but does not produce an arc. The cause can be:

- The consumables are too tight. Loosen the consumables about 1/8th of a turn and try again. The consumables should be just finger-tight.

The torch does not cut completely through the workpiece. The causes can be:

- The cut speed is too fast.
- The consumables are worn.
- The metal being cut is too thick.
- Gouging consumables are installed instead of cutting consumables.
- The work clamp is not attached properly to the workpiece.
- The gas pressure or gas flow rate is too low.

Cut quality is poor. The causes can be:

- The metal being cut is too thick.
- The wrong consumables are being used (gouging consumables are installed instead of cutting consumables, for example).
- You are moving the torch too quickly or too slowly.

The arc sputters and consumables life is shorter than expected. The cause can be:

- Moisture in the gas supply.
- The gas pressure is too low.

How to use the machine torch

Since the Powermax45 and the T45m can be used with a wide variety of cutting tables, track burners, pipe bevelers, and so on, you will need to refer to the manufacturer's instructions for specifics on operating the machine torch in your configuration. However, the information in the following sections will help you optimize cut quality and maximize consumable life.

Ensure the torch and table are set up correctly

- Use a square to align the torch at right angles to the workpiece.
- The torch may travel more smoothly if you clean, check and “tune” the cutting table's rails and drive system. Unsteady machine motion can cause a regular, wavy pattern on the cut surface.
- Ensure that the torch does not touch the workpiece during cutting. Contact with the workpiece can damage the shield and nozzle and affect the cut surface.

Understand and optimize cut quality

There are several factors to consider in cut quality:

- Cut angle — The degree of angularity of the cut edge.
- Dross — The molten material that solidifies on the top or bottom of the workpiece.
- Straightness of the cut surface — The cut surface can be concave or convex.

The following sections explain how these factors can affect cut quality.

Cut or bevel angle

- A positive cut angle, or bevel, results when more material is removed from the top of the cut than from the bottom.
- A negative cut angle results when more material is removed from the bottom of the cut.

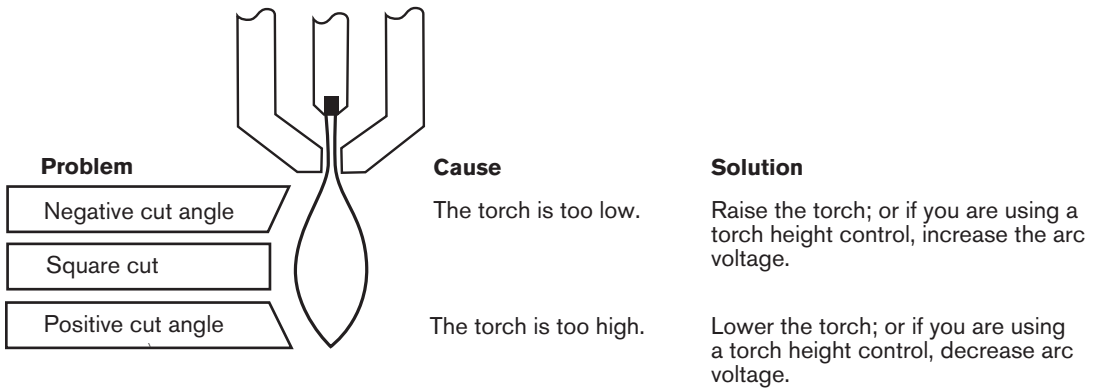

Notes: The squarest cut angle will be on the right side with respect to the forward motion of the torch. The left side will always have some degree of bevel.

To determine whether a cut-angle problem is being caused by the plasma system or the drive system, make a test cut and measure the angle of each side. Next, rotate the torch 90° in its holder and repeat the process. If the angles are the same in both tests, the problem is in the drive system.

If a cut-angle problem persists after “mechanical causes” have been eliminated (see the previous page, *Ensure the torch and table are set up correctly*), check the torch-to-work distance, especially if the cut angles are all positive or all negative. Also consider the material being cut: if the metal is magnetized or hardened, you are more likely to experience cut angle problems.

Dross

Some amount of dross will always be present when cutting with air plasma. However, you can minimize the amount and type of dross by adjusting your system correctly for your application.

Dross appears on the top edge of both pieces of the plate when the the torch is too low (or voltage is too high, if using a torch height control). Adjust the torch or the voltage in small increments (5 volts or less) until the dross is reduced.

Low-speed dross forms when the torch’s cutting speed is too slow and the arc shoots ahead. It forms as a heavy, bubbly deposit at the bottom of the cut and can be removed easily. Increase the speed to reduce this type of dross.

High-speed dross forms when the cutting speed is too fast and the arc lags behind. It forms as a thin, linear bead of solid metal attached very close to the cut. It is welded to the bottom of the cut and is difficult to remove. To reduce high-speed dross:

- Decrease the cutting speed.
- Decrease the torch-to-work distance.

Notes: Dross is more likely to form on warm or hot metal than on cool metal. For example, the first cut in a series of cuts usually produces the least dross. As the workpiece heats up, more dross may form on subsequent cuts.

Dross is more likely to form on mild steel than on stainless steel or aluminum.

Worn or damaged consumables may produce intermittent dross.

Straightness of the cut surface



A typical plasma cut surface is slightly concave.

The cut surface may become more concave, or convex. Correct torch height is required to keep the cut surface acceptably close to straight. Worn consumables also affect the straightness of the cut.



A strongly concave cut surface occurs when the torch-to-work distance is too low. Increase the torch-to-work distance to straighten the cut surface.



A convex cut surface occurs when the torch-to-work distance is too great or the cutting current is too high. First, try lowering the torch, then reduce the cutting current.

To pierce a workpiece using the machine torch

As with the hand torch, you can start a cut with the machine torch at the edge of the workpiece or by piercing the workpiece. Piercing will result in a shorter consumable life than with edge starts.

The cut charts include a column for the recommended torch height when starting a pierce. For the Powermax45, the pierce height is generally 2.5 times the cutting height. Refer to the cut charts for specifics.

The pierce delay must be sufficiently long that the arc can pierce the material before the torch moves, but not so long that the arc “wanders” while trying to find the edge of a large hole.

When piercing maximum thicknesses, the ring of dross that forms during the pierce may become high enough to contact the torch when the torch begins to move after the pierce is complete.

Common machine-cutting faults

The torch's pilot arc will initiate, but will not transfer. Causes can be:

- The work cable's connection on the cutting table is not making good contact or the table is not properly grounded.
- The torch-to-work distance is too large.

The workpiece is not totally penetrated, and there is excessive sparking on the top of the workpiece. Causes can be:

- The work cable's connection on the cutting table is not making good contact or the table is not properly grounded.
- The amperage is set too low. See the cut charts in Section 3 for more information.
- The cut speed is too high. See the cut charts in Section 3 for more information.
- The consumables are worn and need to be replaced.
- The metal being cut exceeds the maximum capacity. See *T45v and T45m specifications* in Section 1.

Dross forms on the bottom of the cut. Causes can be:

- The cutting speed is not correct. See the cut charts in Section 3 for more information.
- The amperage is set too low. See the cut charts in Section 3 for more information.
- The consumables are worn and need to be replaced.

The cut angle is not square. Causes can be:

- The direction of the torch travel is incorrect. The high-quality cut is always on the right with respect to the forward motion of the torch.
- The distance between the torch and the workpiece is not correct.
- The cutting speed is not correct. See the cut charts in Section 3 for more information.
- The consumables are worn and need to be replaced.

The consumables' life is shortened. Causes can be:

- The arc current, arc voltage, travel speed, and other variables are not set as specified in the cut charts.
- Firing the arc in the air (beginning or ending the cut off of the plate surface). Starting at the edge is acceptable as long as the arc makes contact with the workpiece when started.
- Starting a pierce with an incorrect torch height. For the Powermax45, the pierce height is generally 2.5 times the cutting height. Refer to the cut charts for specifics.



Section 5

MAINTENANCE AND REPAIR

In this section:

Perform routine maintenance	5-2
Inspect the consumables	5-3
Basic troubleshooting	5-4
Repairs	5-8
Remove and replace the cover and Mylar® barrier.....	5-8
Replace the work lead (CSA and CE)	5-10
Replace the gas filter element.....	5-11

Perform routine maintenance

		DANGER ELECTRIC SHOCK CAN KILL
	Disconnect the electrical power before you perform any maintenance. All work that requires removal of the power supply cover must be performed by a qualified technician.	

Every use:

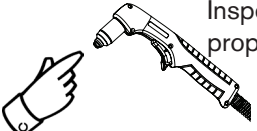

Check the indicator lights and correct any fault conditions.

 Inspect the consumables for proper installation and wear.

Every 3 months:

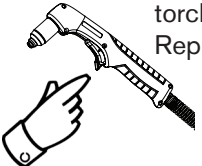

Replace any damaged labels.

 Inspect the trigger for damage. Inspect the torch body for cracks and exposed wires. Replace any damaged parts.



Inspect the power cord and plug. Replace if damaged.

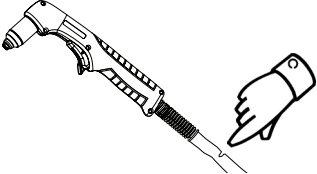



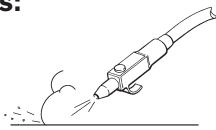
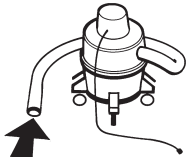

Inspect the torch lead. Replace if damaged.

Every 6 months:

 or 

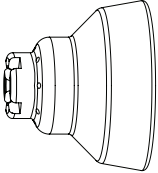
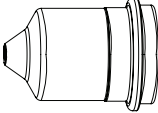
Clean the inside of the power supply with compressed air or a vacuum.

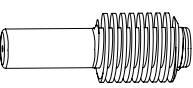
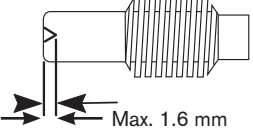
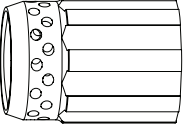
Inspect the consumables

Part	Inspect	Action
	<p>Shield or deflector</p>	<p>The center hole for roundness.</p> <p>The gap between the shield and the nozzle for accumulated debris.</p>
	<p>Nozzle</p> <div style="display: flex; justify-content: space-around; align-items: center;"> <div style="text-align: center;">  Good </div> <div style="text-align: center;">  Worn </div> </div>	<p>Replace if the center hole is not round. Replace the nozzle and the electrode together.</p>
	<p>Electrode</p> <div style="text-align: center;">  Max. 1.6 mm </div>	<p>Replace if the surface is worn or the pit depth is greater than 1/16 inch (1.6 mm) deep. Replace the nozzle and the electrode together.</p>
	<p>Swirl ring</p>	<p>Replace if the surface is damaged or worn or any of the gas holes are blocked.</p>
	<p>Torch o-ring</p>	<p>If the o-ring is dry, lubricate it and the threads with a thin layer of silicone lubricant. If the o-ring is cracked or worn, replace it.</p>





Basic troubleshooting

The following table provides an overview of the most common problems that may arise when using the Powermax45 and explains how to solve them.

If you are unable to fix the problem by following this basic troubleshooting guide or if you need further assistance:

1. Call your Hypertherm distributor or authorized Hypertherm repair facility.
2. Call the nearest Hypertherm office listed in the front of this manual.

Problem	Solutions
The ON/OFF power switch is set to ON (I), but the power ON LED is not illuminated.	<ul style="list-style-type: none"> ▪ Verify that the power cord is plugged into the receptacle. ▪ Verify that the power is ON at the main power panel or at the line-disconnect switch box. * Verify that the line voltage is not too low (more than 15% below the rated voltage).
The power ON LED is illuminated and the gas pressure LED is illuminated yellow and is above or below the center of the pressure bar.	<ul style="list-style-type: none"> ▪ Turn the amperage knob to the gas test position, then unlock the pressure regulator by pulling up on the knob. Turn it to adjust the pressure, then push it down to lock it. ▪ Verify that the gas supply line is connected to the power supply and the gas is turned on. ▪ Inspect the gas supply line for leaks and verify the incoming gas pressure.
The power ON LED is blinking. 	<ul style="list-style-type: none"> ▪ The input line voltage is either too high or too low (a variance greater than $\pm 15\%$ of the rated voltage). Have an electrical technician check the incoming power. See Section 1, <i>Specifications</i>, and <i>Prepare the electrical power</i> in Section 2 for more information.

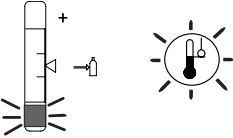
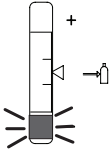

Problem	Solutions
<p>The power ON LED is illuminated and the yellow temperature LED is illuminated.</p> 	<ul style="list-style-type: none"> ▪ Leave the power supply on to allow the fan to cool the power supply. ▪ If the internal temperature of the power supply approaches -22° F (-30° C), the temperature LED may illuminate. Move the power supply to a warmer location.
<p>The power ON LED is illuminated and the torch cap LED is illuminated.</p> 	<ul style="list-style-type: none"> ▪ Turn OFF the power supply. Verify that there are consumables installed. See <i>Install the consumables</i> in Section 3. ▪ If you have just installed the consumables, verify that the consumables are only finger-tight. Loosen them 1/8th of a turn and then restart the power supply. ▪ If the consumables appear to be installed correctly, the torch may be damaged. Contact your Hypertherm distributor or authorized repair facility.
<p>The power ON LED is illuminated and the torch cap LED blinks.</p> 	<p>This indicates either a “torch stuck open” or a “torch stuck closed” situation.</p> <ul style="list-style-type: none"> ▪ If the consumables became loose or were removed while the power supply is ON, turn OFF the power supply, correct the problem and then turn ON the power supply to clear this fault. See <i>Install the consumables</i> in Section 3. ▪ If the consumables appear to be installed correctly, the torch may be damaged. Contact your Hypertherm distributor or authorized repair facility.
<p>The fault LED blinks.</p> 	<ul style="list-style-type: none"> ▪ A blinking fault LED indicates a major fault with the system. A qualified service technician must service the system. Contact your distributor or authorized repair facility.

MAINTENANCE AND REPAIR

Problem	Solutions
<p>The gas pressure bar's LED and the temperature LED alternately blink when the system is turned on.</p> 	<p>This situation indicates that the power supply is receiving a start signal. It is sometimes referred to as a “stuck start.”</p> <ul style="list-style-type: none"> ▪ If the power supply is turned on while the torch trigger is pressed, the system will be disabled. Release the trigger and restart the power supply.
<p>The gas pressure bar's LED illuminates yellow at the bottom of the gauge, and blinks.</p> 	<ul style="list-style-type: none"> ▪ Inlet gas supply pressure is lower than the minimum acceptable level. The LED continues to blink for 10 seconds after the gas pressure is restored to the acceptable range.
<p>The arc does not transfer to the workpiece.</p>	<ul style="list-style-type: none"> ▪ Clean the area where the work clamp contacts the workpiece, to ensure a good metal-to-metal connection. ▪ Inspect the work clamp for damage, and repair it if necessary. ▪ The torch-to-work distance may be too large. Move the torch closer to the workpiece and fire the torch again. See Section 4, <i>Operation</i>.
<p>The arc blows out, but re-ignites when the torch trigger is pressed again.</p>	<ul style="list-style-type: none"> ▪ Inspect the consumable parts and replace them if they are worn or damaged. See <i>Inspect the consumables</i> in this section. ▪ Replace the gas filter element if it is contaminated. See <i>Replace the gas filter element</i> in this section.

Problem	Solutions
The arc sputters and hisses.	<ul style="list-style-type: none">▪ The gas filter element is contaminated. Replace the element – See <i>Replace the gas filter element</i> in this section.▪ Inspect the gas line for moisture. If necessary, install or repair the gas filtration to the power supply. See <i>Prepare the gas supply</i> in Section 2.
The cut quality is poor.	<ul style="list-style-type: none">▪ Verify that the torch is being used correctly. See Section 4, <i>Operation</i>.▪ Inspect the consumables for wear and replace as necessary. See <i>Inspect the consumables</i> in this section.

Repairs

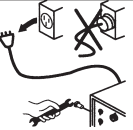
		DANGER ELECTRIC SHOCK CAN KILL
	Disconnect electrical power before performing any maintenance. All work requiring removal of the power supply cover must be performed by a qualified technician.	

Remove and replace the cover and Mylar® barrier

The first step in most maintenance and repair procedures for the Powermax45 is removing the cover and the Mylar barrier. To protect your power supply, it is important to replace both items properly when the maintenance is complete.

Removal

1. Turn OFF the power, disconnect the power cord, and disconnect the gas supply.
2. Use a #2 Phillips screwdriver to remove the 2 screws from the handle on the top of the power supply. Gently pull on the end panel nearest the screw you are removing to keep pressure on the screw. When the screw is almost out, tilt the screwdriver slightly to help pull the screw out of the recessed hole.
3. Tip the end panels back slightly so that you can get the edges of the handle out from underneath them. Set the handle and screws aside. Continue to tilt the end panels outward to release the fan side of the cover from its track. Then lift the cover off the power supply.
4. Remove the Mylar barrier from the power-board side of the power supply.

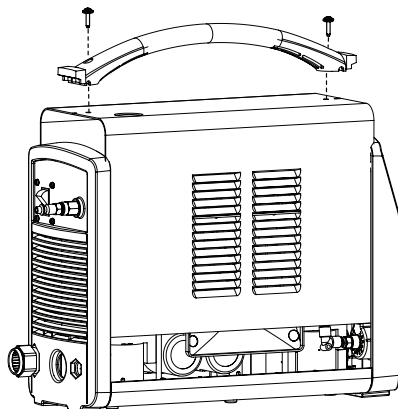

Replacement

1. Hold the Mylar barrier so that the edge with the 3 notches is on the left and the edge with 4 notches is on the right.
2. There is a perforation across the top, about 1.75 inches (4.45 cm) down from the top edge. If you are replacing the Mylar barrier with a new one, you will need to fold it along this perforation so that the top edge bends away from you.
3. Position the barrier so that the folded section will cover the top of the power board. Slide the barrier into place with the bottom edge between the ribs on the base and the power board. The notches on each side of the barrier should align with the ribs on the inside of the endcaps.
4. Being careful not to pinch any of the wires, slide the cover back onto the power supply. Make sure that the bottom edges are in the tracks and that the slot in the top of the cover is aligned with the tab on the front endcap so that the louvers in the cover are in front of the fan. Position the handle over the holes in the top of the cover, then secure the cover with the 2 screws.

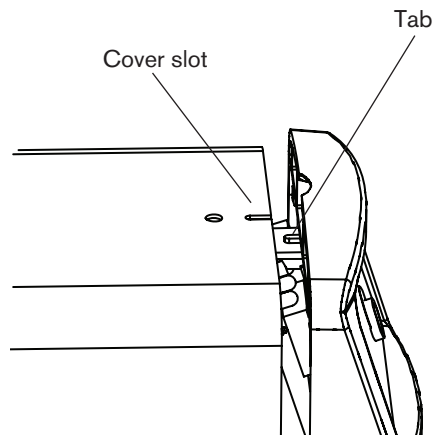
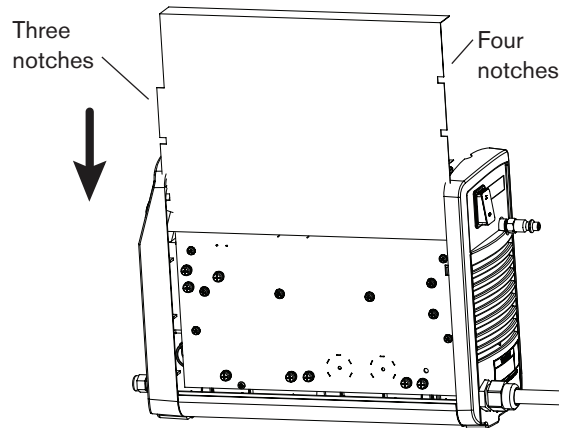

Replace the work lead (CSA and CE)

1. Turn OFF the power, disconnect the power cord, and disconnect the gas supply.
2. Remove the cover from the power supply and remove the Mylar barrier from in front of the power board.
3. Remove the screw from J21 (also labeled “work lead”) on the power board that attaches the lead to the board. Set the screw aside.

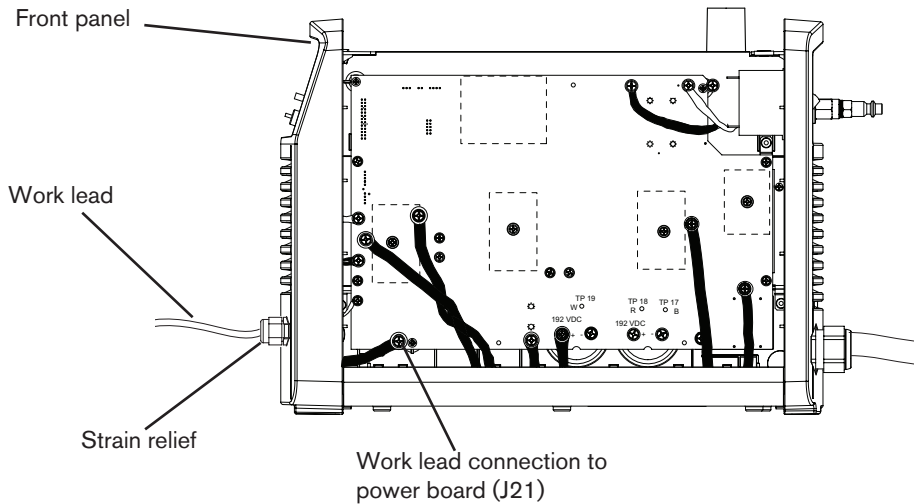

4. Gently tilt the front panel away from the power supply. From the inside of the panel, unscrew the nut that secures the strain relief to the endcap.
5. Thread the connector end of the new work lead through the front panel and fit the strain relief into the hole in the panel.
6. Slide the nut over the work lead's connector. Gently tilt the front panel away from the power supply and screw the nut onto the strain relief.
7. Attach the work lead to the power board at J21 using the screw that you removed earlier. The torque setting for this connection is 20 inch-pounds (23.4 kg cm)
8. Realign the front panel.

9. Replace the Mylar barrier and slide the cover back onto the power supply. Position the handle over the holes in the top of the cover, then secure the cover with the 2 screws.
10. Reconnect the electrical power and the gas supply.

Replace the gas filter element

1. Turn OFF the power, disconnect the power cord, and disconnect the gas supply.
2. Remove the cover from the power supply.
3. Remove the drain hose from the drain in the bottom of the power supply's base.
4. Compress the hose fitting's collar on the gas supply hose and pull the gas hose from the fitting.
5. Unscrew the nut that holds the filter in the bracket. Tip the bottom of the filter away from the power supply.
6. Unscrew the filter bowl from the body and remove it.

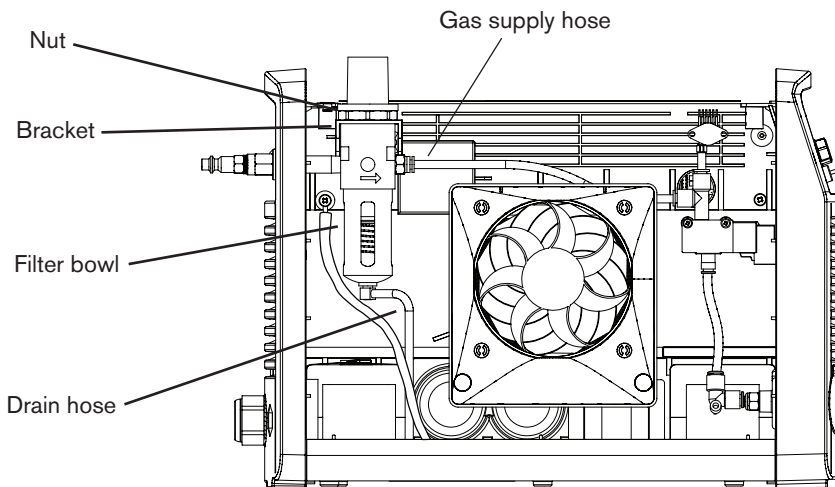

7. Unscrew the element from the filter body while being careful not to allow the element to rotate.
8. Screw the new element to the filter body.

MAINTENANCE AND REPAIR

9. Reattach the filter bowl.
10. Reposition the filter assembly in the bracket and replace its retainer nut.
11. Reconnect the gas supply hose and press the drain hose onto the drain in the bottom of the power supply.
12. Reconnect the gas supply and check for leaks.
13. Slide the cover back onto the power supply. Position the handle over the holes in the top of the cover, then use the 2 screws to secure the cover.
14. Reconnect the electrical power and the gas supply.

Section 6

PARTS

In this section:

Power supply parts.....	6-2
T45v hand torch parts.....	6-5
T45v hand torch consumables.....	6-6
T30v (Powermax30) 30 A consumables	6-6
T45m machine torch parts.....	6-7
T45m machine torch consumables.....	6-8
Accessory parts.....	6-8
Powermax45 labels	6-8

Power supply parts

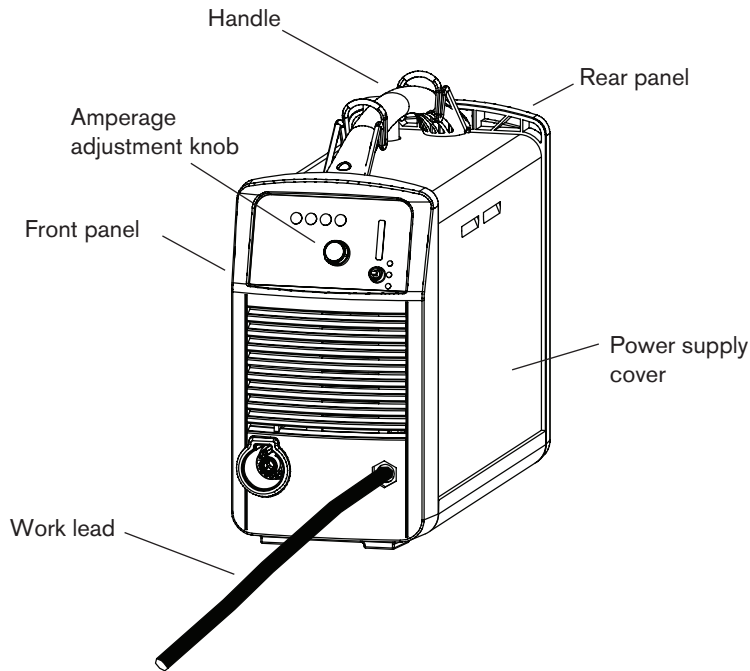

Part number	Description
228269	Kit: Powermax45 front panel
228268	Kit: Powermax45 rear panel
228270	Kit: Cover screws
228267	Kit: Handle and screws
228281	Kit: Power supply cover, CSA
228283	Kit: Power supply cover, CE
228300	Kit: Work lead with clamp, 20 ft (6.1 m)
228307	Kit: Work lead with clamp, 50 ft (15.24 m)
228561	Kit: Ground clamp (not shown)
108616	Amperage adjustment knob

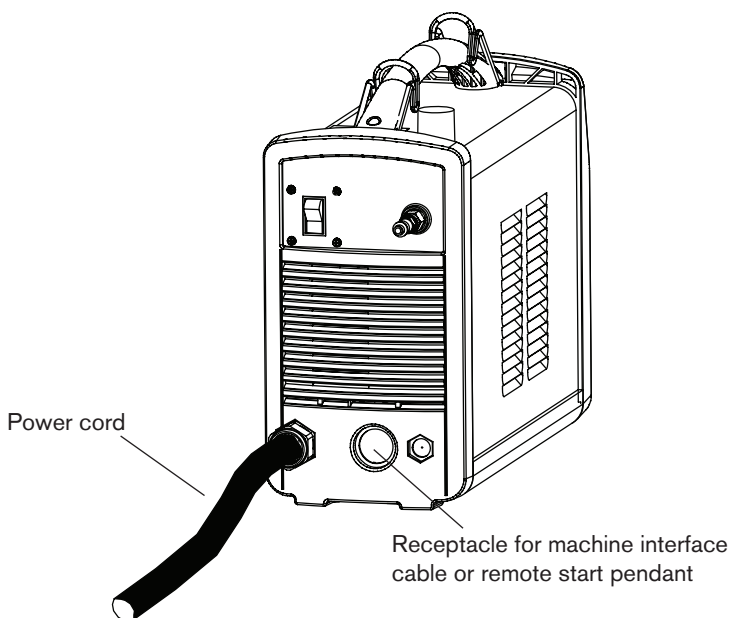

Part number	Description
228278	Kit: Powermax45 power cord, CSA 200-240 V
228277	Kit: Powermax45 power cord, CE 230 V
228276	Kit: Powermax45 power cord, CE 400 V
128650	Remote start pendant for machine torch, 25 ft (7.63 m)
128651	Remote start pendant for machine torch, 50 ft (15.24 m)
128652	Remote start pendant for machine torch, 75 ft (22.86 m)
023206	Machine interface cable (start plasma, arc transfer, and ground), 25 ft (7.63 m)
023279	Machine interface cable (start plasma, arc transfer, and ground), 50 ft (15.24 m)
123966	Powermax45 machine interface cable (start plasma, arc transfer, 50:1 voltage divider, and ground), 25 ft (7.62 m), spade connectors
123967	Powermax45 machine interface cable (start plasma, arc transfer, 50:1 voltage divider, and ground), 50 ft (15.24 m), spade connectors
123896	Machine interface cable (start plasma, arc transfer, 5:1 voltage divider, and ground), 50 ft (15.24 m), D-sub connector with screws

PARTS

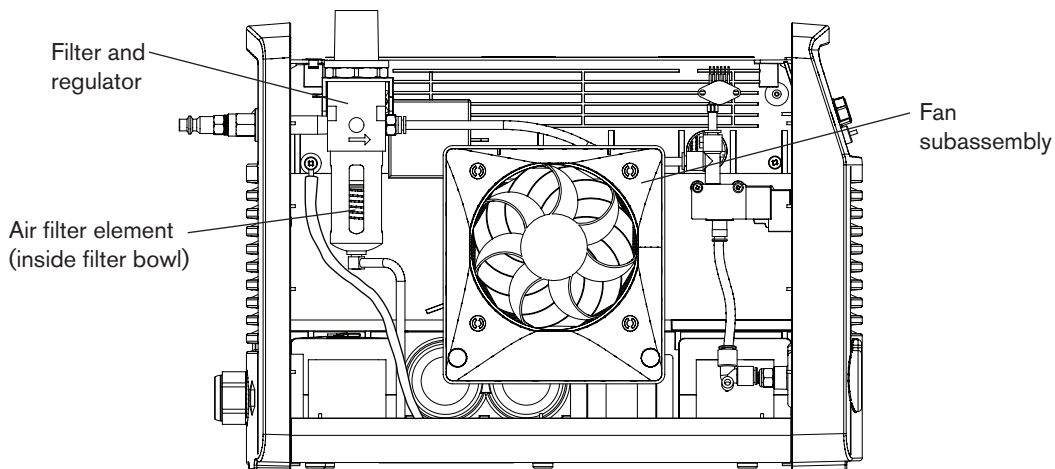

Part number

228286

228287

228302

Description

Kit: Fan subassembly

Kit: Filter and regulator

Kit: Air filter element

T45v hand torch parts

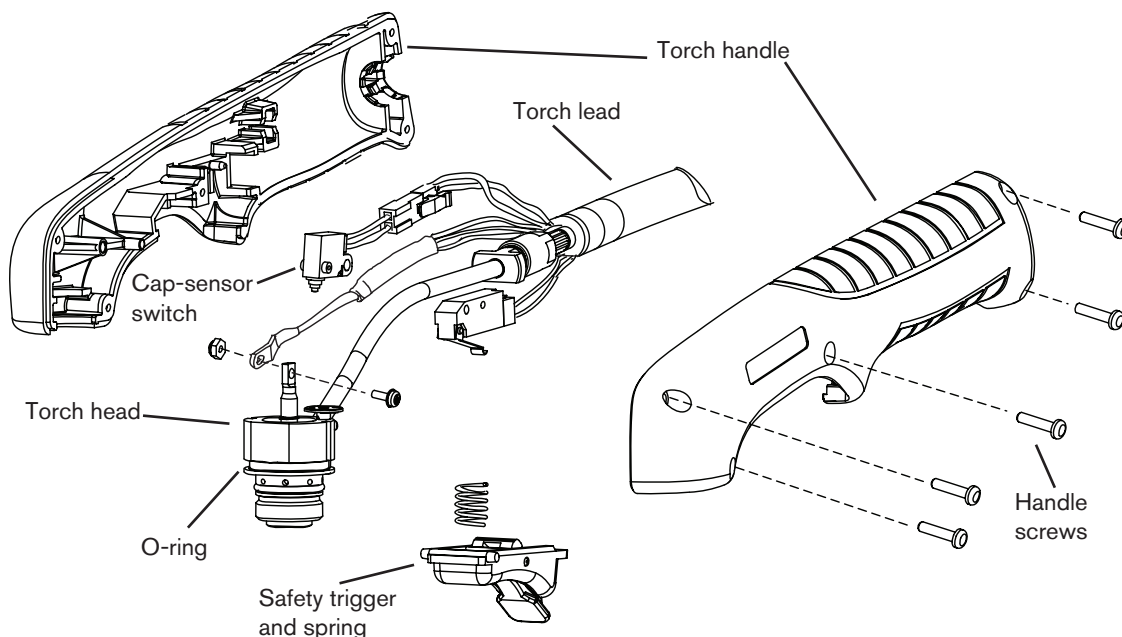

The entire hand torch and lead assembly can be replaced, or individual component parts can be replaced. Part numbers starting with 088 indicate complete torch and lead assemblies.

Part number	Description
088008*	T45v hand torch assembly with 20 ft (6.1 m) lead
088009*	T45v hand torch assembly with 50 ft (15.24 m) lead
228313	Kit: Handle
075714	Screws, #4 x 1/2 SLTD Torx PAN, S/B
002294	Safety trigger and spring replacement
228346	Kit: Torch head replacement
058503	O-ring: Viton 0.626 x 0.070
228109	Kit: Cap-sensor switch replacement
228315	Kit: Torch lead replacement, 20 ft (6.1 m)
228316	Kit: Torch lead replacement, 50 ft (15.24 m)

* The torch assembly also includes one set of the consumables listed on the next page.

PARTS

T45v hand torch consumables

Part number	Description
Shielded	
220669	Electrode
220670	Swirl ring
220713	Retaining cap
220671	Nozzle
220674	Shield
Gouging*	
220675	Shield
220672	Nozzle
Unshielded*	
220717	Deflector
220718	Nozzle

*The swirl ring, retaining cap, and electrode for these applications are the same as those for the shielded application. Unshielded consumables for the hand torch are not available in CE-regulated countries.

T30v (Powermax30) 30 A consumables

Part number	Description
220569	Deflector
220483	Retaining cap
220480	Nozzle
220479	Swirl ring
220478	Electrode

T45m machine torch parts

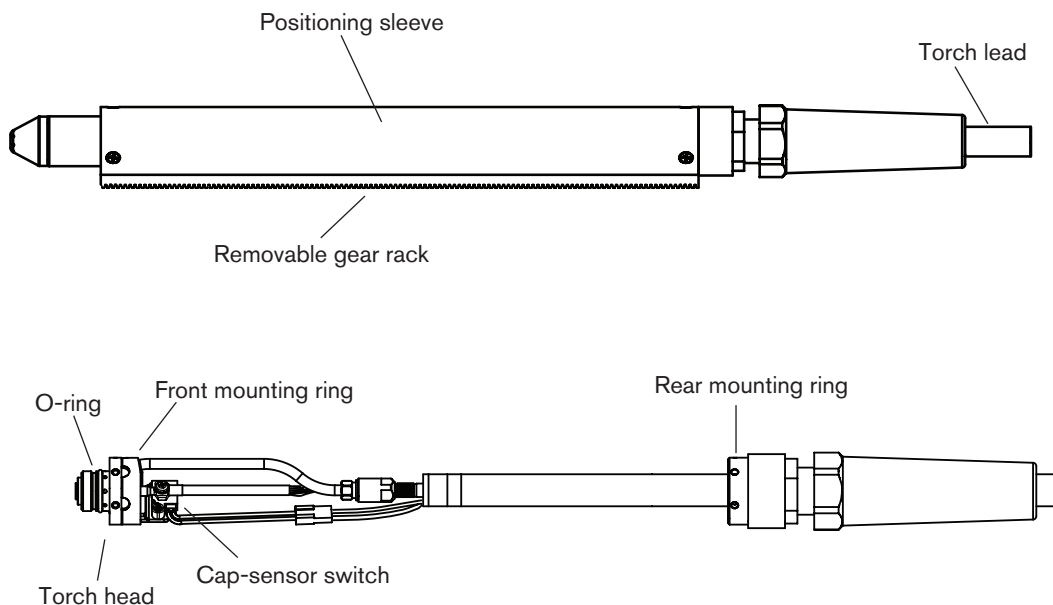

The entire machine torch and lead assembly can be replaced, or individual component parts can be replaced. Part numbers starting with 088 indicate complete torch and lead assemblies.

Part number	Description
088010*	T45m machine torch assembly with 25 ft (7.6 m) lead
088011*	T45m machine torch assembly with 35 ft (10.67 m) lead
088012*	T45m machine torch assembly with 50 ft (15.24 m) lead
228228	Kit: T45m positioning sleeve
228229	Kit: T45m removable gear rack
228322	Kit: Front mounting ring
228323	Kit: Rear mounting ring
228320	Kit: T45m torch head replacement
228321	Kit: T45m cap-sensor switch replacement
058503	O-ring
228317	T45m torch lead replacement, 25 ft (7.6 m)
228318	T45m torch lead replacement, 35 ft (10.67 m)
228319	T45m torch lead replacement, 50 ft (15.24 m)

* The torch assembly also includes one set of the consumables listed on the next page.

PARTS

T45m machine torch consumables

Part number	Description
Shielded	
220669	Electrode
220670	Swirl ring
220713	Retaining cap
220719	Ohmic sensing retaining cap
220671	Nozzle
220673	Shield

Unshielded*

220717	Deflector
220718	Nozzle

*The swirl ring, retaining cap, and electrode for the unshielded application are the same as those for the shielded application.

The T30v (Powermax30) 30 A consumables can be used on the T45m as well. The part numbers are listed on page 6-6.

Accessory parts

Part number	Description
024548	Leather torch sheathing, 25 ft (7.5 m)
128658	Gouging heat shield
127102	Basic plasma (circle) cutting guide
027668	Deluxe plasma (circle) cutting guide
127219	Powermax45 dust cover
127217	Powermax45 shoulder strap
128647	Kit: Eliminator air filtration

Powermax45 labels

Part number	Description
228272	Kit: Powermax45 labels, CE
228264	Kit: Powermax45 labels, CSA

The label kits include the consumable label, appropriate safety labels, as well as front and side decals. The consumable and safety labels are pictured on the next page.

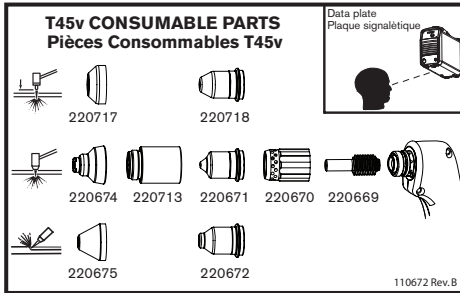

Consumable label



CE safety label

WARNING		AVERTISSEMENT	
<p>Read and follow these instructions, employer safety practices, and material safety data sheets. Refer to ANSI Z49.1 - "Safety in Welding, Cutting and Allied Processes" from American Welding Society (http://www.aws.org) and OSHA Safety and Health Standards, 29 CFR 1910 (http://www.osha.gov).</p>		<p>Plasma cutting can be injurious to operator and persons in the work area. Consult manual before operating. Failure to follow all these safety instructions can result in death.</p>	
<p>1. Cutting sparks can cause explosion or fire. 1.1 Do not cut near flammables. 1.2 Have a fire extinguisher ready and ready to use. 1.3 Do not use a drum or other closed container as a cutting table.</p>		<p>1. Les étincelles de coupage peuvent provoquer une explosion ou un incendie. 1.1 Ne pas couper près des matières inflammables. 1.2 Un extincteur doit être à portée et prêt à être utilisé. 1.3 Ne pas utiliser un fût ou un autre contenant fermé comme table de coupage.</p>	
<p>2. Plasma arc can injure and burn; point the nozzle away from yourself. Arc starts instantly when triggered. 2.1 Turn off power before disconnecting torch. 2.2 Do not grip the workpiece near the cutting path. 2.3 Wear complete body protection.</p>		<p>2. L'arc plasma peut blesser et brûler; diriger la buse de soi. Il s'allume instantanément quand on l'active. 2.1 Couper l'alimentation avant de démonter la torche. 2.2 Ne pas saisir la pièce à couper de la trajectoire de coupage. 2.3 Se protéger entièrement le corps.</p>	
<p>3. Hazardous voltage. Risk of electric shock or burn. 3.1 Wear insulating gloves. Replace gloves when wet or damaged. 3.2 Protect from shock by insulating yourself from work and ground. 3.3 Disconnect power before servicing. Do not touch live parts.</p>		<p>3. Tension dangereuse. Risque de choc électrique ou de brûlure. 3.1 Porter des gants isolants. Remplacer les gants quand ils sont humides ou endommagés. 3.2 Se protéger contre les chocs en s'isolant de la pièce et de la terre. 3.3 Couper l'alimentation avant l'entretien. Ne pas toucher les pièces sous tension.</p>	
<p>4. Plasma fumes can be hazardous. 4.1 Do not inhale fumes. 4.2 Use forced ventilation or local exhaust to remove the fumes. 4.3 Do not operate in closed spaces. Remove fumes with ventilation.</p>		<p>4. Les fumées plasma peuvent être dangereuses. 4.1 Ne pas inhaler les fumées. 4.2 Utiliser une ventilation forcée ou un extracteur local pour dégager les fumées. 4.3 Ne pas couper dans des espaces clos. Chasser les fumées par ventilation.</p>	
<p>5. Arc rays can burn eyes and injure skin. 5.1 Wear correct and appropriate protective equipment to protect head, eyes, ears, hands, and body. Shutout shirt collar. Putout ears from noise. Use welding helmet with the correct shade of filter.</p>		<p>5. Les rayons d'arc peuvent brûler les yeux et blesser la peau. 5.1 Porter un bon équipement de protection pour se protéger la tête, les yeux, les oreilles, les mains et le corps. Boutonner le col de la chemise. Protéger les oreilles contre le bruit. Utilisez un masque de soudage avec un filtre de nuance appropriée.</p>	
<p>6. Become trained. Only qualified personnel should operate this equipment. Use torches specified in the manual. Keep non-qualified personnel and children away. 7. Do not remove, destroy, or cover this label. Replace if it is missing, damaged, or worn. (PN) 110673 Rev.D</p>		<p>6. Suivre une formation. Seul le personnel qualifié a le droit de faire fonctionner cet équipement. Utilisez uniquement les torches indiquées dans le manuel. Le personnel non qualifié et les enfants doivent se tenir à l'écart. 7. Ne pas enlever, détruire ni couvrir cette étiquette. La remplacer si elle est absente, endommagée ou usée. (PN) 110673 Rev.D</p>	

CSA safety label



Maximum pressure label

