



OM-290023C

2023-03

Processes



TIG (GTAW) Welding



Stick (SMAW) Welding

Description



120-480 Volt Models w/Autoline® Arc Welding Power Source

Dynasty® 210

CE And Non-CE Models

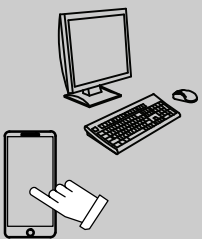
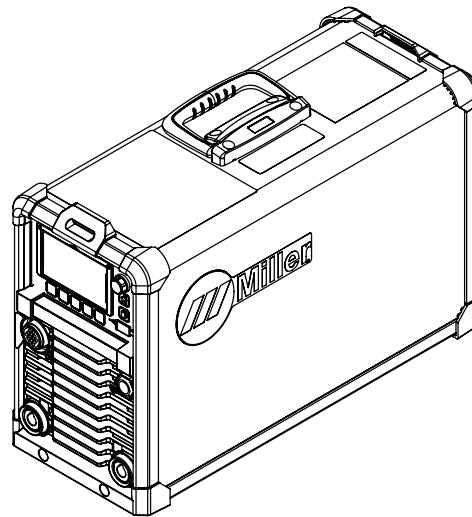

For product information,
Owner's Manual translations,
and more, visit

www.MillerWelds.com

OWNER'S MANUAL

From Miller to You

Thank you and congratulations on choosing Miller. Now you can get the job done and get it done right. We know you don't have time to do it any other way.

That's why when Niels Miller first started building arc welders in 1929, he made sure his products offered long-lasting value and superior quality. Like you, his customers couldn't afford anything less. Miller products had to be more than the best they could be. They had to be the best you could buy.

Today, the people that build and sell Miller products continue the tradition. They're just as committed to providing equipment and service that meets the high standards of quality and value established in 1929.

This Owner's Manual is designed to help you get the most out of your Miller products. Please take time to read the Safety Precautions. They will help you protect yourself against potential hazards on the worksite. We've made installation and operation quick and easy. With Miller, you can count on years of reliable service with proper maintenance. And if for some reason the unit needs repair, there's a Troubleshooting section that will help you figure out what the problem is, and our extensive service network is there to help fix the problem. Warranty and maintenance information for your particular model are also provided.

Miller Electric manufactures a full line of welders and welding-related equipment. For information on other quality Miller products, contact your local Miller distributor to receive the latest full line catalog or individual specification sheets. **To locate your nearest distributor or service agency call**

1-800-4-A-Miller, or visit us at www.MillerWelds.com on the web.



Working as hard as you do – every power source from Miller is backed by the most hassle-free warranty in the business.



ISO 9001
Quality

Miller is the first welding equipment manufacturer in the U.S.A. to be registered to the ISO 9001 Quality System Standard.



TABLE OF CONTENTS

SECTION 1 – SAFETY PRECAUTIONS – READ BEFORE USING	1
1-1 Symbol Usage	1
1-2 Arc Welding Hazards	1
1-3 Additional Hazards For Installation, Operation, And Maintenance	3
1-4 California Proposition 65 Warnings	4
1-5 Principal Safety Standards	4
1-6 EMF Information	4
SECTION 2 – CONSIGNES DE SÉCURITÉ - LIRE AVANT UTILISATION	5
2-1 Symboles utilisés	5
2-2 Dangers relatifs au soudage à l'arc	5
2-3 Symboles de dangers supplémentaires en relation avec l'installation, le fonctionnement et la maintenance	7
2-4 Proposition californienne 65 Avertissements	8
2-5 Principales normes de sécurité	8
2-6 Informations relatives aux CEM	9
SECTION 3 – DEFINITIONS	10
3-1 Additional Safety Symbol Definitions	10
3-2 Miscellaneous Symbols And Definitions	12
SECTION 4 – SPECIFICATIONS	14
4-1 Serial Number And Rating Label Location	14
4-2 Software Licensing Agreement	14
4-3 Information About Default Weld Parameters And Settings	14
4-4 Specifications	14
4-5 Dimensions, Weights, And Mounting Options	15
4-6 Static Characteristics	17
4-7 Environmental Specifications	17
4-8 Duty Cycle And Overheating	19
SECTION 5 – INSTALLATION	20
5-1 Selecting A Location	20
5-2 Selecting Cable Sizes ¹	21
5-3 Connections	21
5-4 Cooler Connections	22
5-5 Arranging Weld Cables To Reduce Welding Circuit Inductance	23
5-6 Electrical Service Guide (1-Phase)	24
5-7 Electrical Service Guide (3-Phase)	25
5-8 Connecting 1-Phase Input Power	26
5-9 Connecting 3-Phase Input Power	27
5-10 Remote 14 Receptacle Information	28
5-11 Simple Automation Application	28
5-12 Software Updates	29
SECTION 6 – OPERATION	30
6-1 Home Screen - Primary	30
6-2 Process Selection	31
6-3 Trigger Selection	32
6-4 Pulser Selections	33
6-5 AC Waveform Selection	35
6-6 Tungsten Selection	36
6-7 Parameter Adjustment (AC Frequency)	37
6-8 Home Screen - Sequencer - 2T Slope And Timers	38
6-9 Tech Menu	39
6-10 Locks And Limits Screen	40
6-11 Programs/Memories	41
6-12 USB Menu	42
SECTION 7 – MAINTENANCE AND TROUBLESHOOTING	43
7-1 Routine Maintenance	43
7-2 Blowing Out Inside Of Unit	44
7-3 Coolant Maintenance	44
7-4 Coolant Specifications	45
7-5 Troubleshooting Table	46
SECTION 8 – PARTS LIST	47
8-1 Recommended Spare Parts	47
SECTION 9 – ELECTRICAL DIAGRAMS	48
SECTION 10 – HIGH FREQUENCY	49

TABLE OF CONTENTS

10-1	Welding Processes Requiring High Frequency	49
10-2	Installation Showing Possible Sources Of HF Interference	49
10-3	Recommended Installation To Reduce HF Interference	50
SECTION 11 – TIG PROCEDURES		51
11-1	Lift-Arc And HF TIG Start Procedures	51
SECTION 12 – SELECTING AND PREPARING A TUNGSTEN FOR DC OR AC WELDING WITH INVERTER MACHINES.....		52
12-1	Selecting Tungsten Electrode	52
12-2	Preparing Tungsten Electrode For DC Electrode Negative (DCEN) Welding Or AC Welding With Inverter Machines.....	53
SECTION 13 – STICK WELDING (SMAW) GUIDELINES		54
13-1	Electrode And Amperage Selection Chart.....	54



DECLARATION OF CONFORMITY

for European Community (CE marked) products.

MILLER Electric Mfg. LLC, 1635 Spencer Street, Appleton, WI 54914 U.S.A. declares that the product(s) identified in this declaration conform to the essential requirements and provisions of the stated Council Directive(s), Commission Regulation(s) and Standard(s).

Product/Apparatus Identification:

Product	Stock Number
DYNASTY 210 (AUTO-LINE 120-480) CPS, CE	907816003

Council Directives and Commission Regulations:

- 2014/35/EU Low voltage
- 2014/30/EU Electromagnetic compatibility
- 2009/125/EC and regulation 2019/1784 Ecodesign requirements for energy-related products
- 2011/65/EU and amendment 2015/863 Restriction of the use of certain hazardous substances in electrical and electronic equipment

Standards:

- EN IEC 60974-1:2018/A1:2019 Arc welding equipment – Part 1: Welding power sources
- EN IEC 60974-3:2019 Arc welding equipment – Part 3: Arc striking and stabilizing devices
- EN 60974-10:2014/A1:2015 Arc welding equipment – Part 10: Electromagnetic compatibility requirements
- EN IEC 63000:2018 – Technical documentation for the assessment of electrical and electronic products with respect to the restriction of hazardous substances

Signatory:

July 19, 2022

David A. Werba
MANAGER, PRODUCT DESIGN COMPLIANCE

Date of Declaration



DECLARATION OF CONFORMITY

for European Community (CE marked) products.

MILLER Electric Mfg. LLC, 1635 Spencer Street, Appleton, WI 54914 U.S.A. declares that the product(s) identified in this declaration conform to the essential requirements and provisions of the stated Council Directive(s), Commission Regulation(s) and Standard(s).

Product/Apparatus Identification:

Product	Stock Number
DYNASTY 210 TIGRUNNER, CE	907816004

Council Directives and Commission Regulations:

- 2014/35/EU Low voltage
- 2014/30/EU Electromagnetic compatibility
- 2009/125/EC and regulation 2019/1784 Ecodesign requirements for energy-related products
- 2011/65/EU and amendment 2015/863 Restriction of the use of certain hazardous substances in electrical and electronic equipment

Standards:

- EN IEC 60974-1:2018/A1:2019 Arc welding equipment – Part 1: Welding power sources
- EN IEC 60974-2:2019 Arc welding equipment – Part 2 Liquid cooling systems
- EN IEC 60974-3:2019 Arc welding equipment – Part 3: Arc striking and stabilizing devices
- EN 60974-10:2014/A1:2015 Arc welding equipment – Part 10: Electromagnetic compatibility requirements
- EN IEC 63000:2018 – Technical documentation for the assessment of electrical and electronic products with respect to the restriction of hazardous substances

Signatory:

July 14, 2022

David A. Werba
MANAGER, PRODUCT DESIGN COMPLIANCE

Date of Declaration

291844A



DECLARATION OF CONFORMITY

For United Kingdom (UKCA marked) products.

MILLER Electric Mfg. LLC, 1635 West Spencer Street, Appleton, WI 54914 U.S.A. declares that the product(s) identified in this declaration conform to the essential requirements and provisions of the stated Regulation(s) and Standard(s).

Product/Apparatus Identification:

Product	Stock Number
DYNASTY 210 (AUTO-LINE 120-480) CPS, CE	907816003

Regulations:

- S.I. 2016/1101 Electrical Equipment (Safety) Regulations 2016
- S.I. 2016/1091 Electromagnetic Compatibility Regulations 2016
- S.I. 2009/125/EC and regulation 2019/1784 Ecodesign requirements for energy-related products
- S.I. 2012/3032 Restriction of the Use of Certain Hazardous Substances in Electrical and Electronic Equipment Regulations 2012

Standards:

- EN IEC 60974-1:2018/A1:2019 Arc welding equipment – Part 1 Welding power sources
- EN IEC 60974-3:2013 Arc welding equipment – Part 3: Arc striking and stabilizing devices
- EN 60974-10:2014/A1:2015 Arc welding equipment – Part 10: Electromagnetic compatibility requirements
- EN IEC 63000:2018 Technical documentation for the assessment of electrical and electronic products with respect to the restriction of hazardous substances

Signatory:

July 14, 2022

David A. Werba
MANAGER, PRODUCT DESIGN COMPLIANCE

Date of Declaration

291843A



DECLARATION OF CONFORMITY

For United Kingdom (UKCA marked) products.

MILLER Electric Mfg. LLC, 1635 West Spencer Street, Appleton, WI 54914 U.S.A. declares that the product(s) identified in this declaration conform to the essential requirements and provisions of the stated Regulation(s) and Standard(s).

Product/Apparatus Identification:

Product	Stock Number
DYNASTY 210 TIGRUNNER, CE	907816004

Regulations:

- S.I. 2016/1101 Electrical Equipment (Safety) Regulations 2016
- S.I. 2016/1091 Electromagnetic Compatibility Regulations 2016
- S.I. 2021/745 Ecodesign for Energy-Related Products and Energy Regulations 2021
- S.I. 2012/3032 Restriction of the Use of Certain Hazardous Substances in Electrical and Electronic Equipment Regulations 2012

Standards:

- EN IEC 60974-1:2018/A1:2019 Arc welding equipment – Part 1 Welding power sources
- EN IEC 60974-2:2019 Arc welding equipment – Part 2: Liquid cooling systems
- EN IEC 60974-3:2013 Arc welding equipment – Part 3: Arc striking and stabilizing devices
- EN 60974-10:2014/A1:2015 Arc welding equipment – Part 10: Electromagnetic compatibility requirements
- EN IEC 63000:2018 Technical documentation for the assessment of electrical and electronic products with respect to the restriction of hazardous substances

Signatory:

July 14, 2022

David A. Werba
MANAGER, PRODUCT DESIGN COMPLIANCE

Date of Declaration

291842A

EMF DATA SHEET FOR ARC WELDING POWER SOURCE



Product/Apparatus Identification

Product	Stock Number
DYNASTY 210 DX (AUTO-LINE 120-480 V) CPS (CE)	907686003
DYNASTY 210 (AUTO-LINE 120-480) CPS, CE	907816003
DYNASTY 210 TIGRUNNER, CE	907816004

Compliance Information Summary

Applicable regulation Directive 2014/35/EU

Reference limits Directive 2013/35/EU, Recommendation 1999/519/EC

Applicable standards IEC 62822-1:2016, IEC 62822-2:2016

Intended use for occupational use for use by laymen

Non-thermal effects need to be considered for workplace assessment YES NO

Thermal effects need to be considered for workplace assessment YES NO

Data is based on maximum power source capability (valid unless firmware/hardware is changed)

Data is based on worst case setting/program (only valid until setting options/welding programs are changed)

Data is based on multiple settings/programs (only valid until setting options/welding programs are changed)

Occupational exposure is below the Exposure Limit Values (ELVs) for health effects at the standardized configurations YES NO
(if NO, specific required minimum distances apply)

Occupational exposure is below the Exposure Limit Values (ELVs) for sensory effects at the standardized configurations n.a YES NO
(if applicable and NO, specific measures are needed)

Occupational exposure is below the Action Levels (ALs) at the standardized configurations n.a YES NO
(if applicable and NO, specific signage is needed)

EMF Data for Non-thermal Effects

Exposure Indices (EIs) and distances to welding circuit (for each operation mode, as applicable)

	Head		Trunk	Limb (hand)	Limb (thigh)
	Sensory Effects	Health Effects			
Standardized distance	10 cm	10 cm	10 cm	3 cm	3 cm
ELV EI @ standardized distance	0.13	0.12	0.20	0.11	0.26
Required minimum distance	1 cm	1 cm	1 cm	1 cm	1 cm

Distance where all occupational ELV Exposure Indices fall below 0.20 (20%) 10 cm

Distance where all general public ELV Exposure Indices fall below 1.00 (100%) 120 cm

Tested by: Tony Samimi Date tested: 2016-02-18

275605-B

SECTION 1 – SAFETY PRECAUTIONS – READ BEFORE USING

 Protect yourself and others from injury—read, follow, and save these important safety precautions and operating instructions.

1-1. Symbol Usage

 **DANGER!** – Indicates a hazardous situation which, if not avoided, will result in death or serious injury. The possible hazards are shown in the adjoining symbols or explained in the text.

 Indicates a hazardous situation which, if not avoided, could result in death or serious injury. The possible hazards are shown in the adjoining symbols or explained in the text.

NOTICE – Indicates statements not related to personal injury.

 Indicates special instructions.



This group of symbols means Warning! Watch Out! ELECTRIC SHOCK, MOVING PARTS, and HOT PARTS hazards. Consult symbols and related instructions below for necessary actions to avoid these hazards.

1-2. Arc Welding Hazards

 The symbols shown below are used throughout this manual to call attention to and identify possible hazards. When you see the symbol, watch out, and follow the related instructions to avoid the hazard. The safety information given below is only a summary of the more complete safety information found in the Principal Safety Standards. Read and follow all Safety Standards.

 Only qualified persons should install, operate, maintain, and repair this equipment. A qualified person is defined as one who, by possession of a recognized degree, certificate, or professional standing, or who by extensive knowledge, training and experience, has successfully demonstrated the ability to solve or resolve problems relating to the subject matter, the work, or the project and has received safety training to recognize and avoid the hazards involved.

 During operation, keep everybody, especially children, away.



ELECTRIC SHOCK can kill.

Touching live electrical parts can cause fatal shocks or severe burns. The electrode and work circuit is electrically live whenever the output is on.

The input power circuit and machine internal circuits are also live when power is on. In semiautomatic or automatic wire welding, the wire, wire reel, drive roll housing, and all metal parts touching the welding wire are electrically live. Incorrectly installed or improperly grounded equipment is a hazard.

- Do not touch live electrical parts.
- Wear dry, hole-free insulating gloves and body protection.
- Insulate yourself from work and ground using dry insulating mats or covers big enough to prevent any physical contact with the work or ground.
- Do not use AC weld output in damp, wet, or confined spaces, or if there is a danger of falling.
- Use AC output ONLY if required for the welding process.
- If AC output is required, use remote output control if present on unit.
- Additional safety precautions are required when any of the following electrically hazardous conditions are present: in damp locations or while wearing wet clothing; on metal structures such as floors, gratings, or scaffolds; when in cramped positions such as sitting, kneeling, or lying; or when there is a high risk of unavoidable or accidental contact with the workpiece or ground. For these conditions, use the following equipment in order presented: 1) a semiautomatic DC constant voltage (wire) welder, 2) a DC manual

(stick) welder, or 3) an AC welder with reduced open-circuit voltage. In most situations, use of a DC, constant voltage wire welder is recommended. And, do not work alone!

- Disconnect input power or stop engine before installing or servicing this equipment. Lockout/tagout input power according to OSHA 29 CFR 1910.147 (see Safety Standards).
- Properly install, ground, and operate this equipment according to its Owner's Manual and national, state, and local codes.
- Always verify the supply ground—check and be sure that input power cord ground wire is properly connected to ground terminal in disconnect box or that cord plug is connected to a properly grounded receptacle outlet.
- When making input connections, attach proper grounding conductor first—double-check connections.
- Keep cords dry, free of oil and grease, and protected from hot metal and sparks.
- Frequently inspect input power cord and ground conductor for damage or bare wiring—replace immediately if damaged—bare wiring can kill.
- Turn off all equipment when not in use.
- Do not use worn, damaged, undersized, or repaired cables.
- Do not drape cables over your body.
- If earth grounding of the workpiece is required, ground it directly with a separate cable.
- Do not touch electrode if you are in contact with the work, ground, or another electrode from a different machine.
- Use only well-maintained equipment. Repair or replace damaged parts at once. Maintain unit according to manual.
- Do not touch electrode holders connected to two welding machines at the same time since double open-circuit voltage will be present.
- Wear a safety harness if working above floor level.
- Keep all panels and covers securely in place.
- Clamp work cable with good metal-to-metal contact to workpiece or worktable as near the weld as practical.
- Insulate work clamp when not connected to workpiece to prevent contact with any metal object.
- Do not connect more than one electrode or work cable to any single weld output terminal. Disconnect cable for process not in use.
- Use GFCI protection when operating auxiliary equipment in damp or wet locations.



HOT PARTS can burn.

- Do not touch hot parts bare handed.
- Allow cooling period before working on equipment.
- To handle hot parts, use proper tools and/or wear heavy, insulated welding gloves and clothing to

prevent burns.

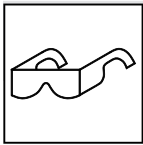

FLYING METAL OR DIRT can injure eyes.

- Welding, chipping, wire brushing, and grinding cause sparks and flying metal. As welds cool, they can throw off slag.
- Wear approved safety glasses with side shields even under your welding helmet.



FUMES AND GASES can be hazardous.

Welding produces fumes and gases. Breathing these fumes and gases can be hazardous to your health.

- Keep your head out of the fumes. Do not breathe the fumes.
- Ventilate the work area and/or use local forced ventilation at the arc to remove welding fumes and gases. The recommended way to determine adequate ventilation is to sample for the composition and quantity of fumes and gases to which personnel are exposed.
- If ventilation is poor, wear an approved air-supplied respirator.
- Read and understand the Safety Data Sheets (SDSs) and the manufacturer's instructions for adhesives, coatings, cleaners, consumables, coolants, degreasers, fluxes, and metals.
- Work in a confined space only if it is well ventilated, or while wearing an air-supplied respirator. Always have a trained watchperson nearby. Welding fumes and gases can displace air and lower the oxygen level causing injury or death. Be sure the breathing air is safe.
- Do not weld in locations near degreasing, cleaning, or spraying operations. The heat and rays of the arc can react with vapors to form highly toxic and irritating gases.
- Do not weld on coated metals, such as galvanized, lead, or cadmium plated steel, unless the coating is removed from the weld area, the area is well ventilated, and while wearing an air-supplied respirator. The coatings and any metals containing these elements can give off toxic fumes if welded.



BUILDUP OF GAS can injure or kill.

- Shut off compressed gas supply when not in use.
- Always ventilate confined spaces or use approved air-supplied respirator.



ARC RAYS can burn eyes and skin.

Arc rays from the welding process produce intense visible and invisible (ultraviolet and infrared) rays that can burn eyes and skin. Sparks fly off from the weld.

- Wear an approved welding helmet fitted with a proper shade of filter lenses to protect your face and eyes from arc rays and sparks when welding or watching (see ANSI Z49.1 and Z87.1 listed in Safety Standards).
- Wear approved safety glasses with side shields under your helmet.
- Use protective screens or barriers to protect others from flash, glare, and sparks; warn others not to watch the arc.
- Wear body protection made from leather or flame-resistant clothing (FRC). Body protection includes oil-free clothing such as leather gloves, heavy shirt, cuffless trousers, high shoes, and a cap.



WELDING can cause fire or explosion.

Welding on closed containers, such as tanks, drums, or pipes, can cause them to blow up. Sparks can fly off from the welding arc. The flying sparks, hot workpiece, and hot equipment can cause fires and burns. Accidental contact of electrode to metal objects can cause sparks, explosion, overheating, or fire. Check and be sure the area is safe before doing any welding.

- Remove all flammables within 35 ft (10.7 m) of the welding arc. If this is not possible, tightly cover them with approved covers.
- Do not weld where flying sparks can strike flammable material.
- Protect yourself and others from flying sparks and hot metal.
- Be alert that welding sparks and hot materials from welding can easily go through small cracks and openings to adjacent areas.
- Watch for fire, and keep a fire extinguisher nearby.
- Be aware that welding on a ceiling, floor, bulkhead, or partition can cause fire on the hidden side.
- Do not cut or weld on tire rims or wheels. Tires can explode if heated. Repaired rims and wheels can fail. See OSHA 29 CFR 1910.177 listed in Safety Standards.
- Do not weld on containers that have held combustibles, or on closed containers such as tanks, drums, or pipes unless they are properly prepared according to AWS F4.1 (see Safety Standards).
- Do not weld where the atmosphere can contain flammable dust, gas, or liquid vapors (such as gasoline).
- Connect work cable to the work as close to the welding area as practical to prevent welding current from traveling long, possibly unknown paths and causing electric shock, sparks, and fire hazards.
- Do not use welder to thaw frozen pipes.
- Remove stick electrode from holder or cut off welding wire at contact tip when not in use.
- Wear body protection made from leather or flame-resistant clothing (FRC). Body protection includes oil-free clothing such as leather gloves, heavy shirt, cuffless trousers, high shoes, and a cap.
- Remove any combustibles, such as a butane lighter or matches, from your person before doing any welding.
- After completion of work, inspect area to ensure it is free of sparks, glowing embers, and flames.
- Use only correct fuses or circuit breakers. Do not oversize or bypass them.
- Follow requirements in OSHA 1910.252 (a) (2) (iv) and NFPA 51B for hot work and have a fire watcher and extinguisher nearby.
- Read and understand the Safety Data Sheets (SDSs) and the manufacturer's instructions for adhesives, coatings, cleaners, consumables, coolants, degreasers, fluxes, and metals.

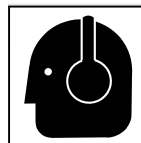

NOISE can damage hearing.

Noise from some processes or equipment can damage hearing.

- Wear approved ear protection if noise level is high.



ELECTRIC AND MAGNETIC FIELDS (EMF) can affect Implanted Medical Devices.

- Wearers of Pacemakers and other Implanted Medical Devices should keep away.
- Implanted Medical Device wearers should consult their doctor and the device manufacturer before going near arc welding, spot welding, gouging, plasma arc cutting, or induction heating operations.



CYLINDERS can explode if damaged.

Compressed gas cylinders contain gas under high pressure. If damaged, a cylinder can explode. Since gas cylinders are normally part of the welding process, be sure to treat them carefully.

- Protect compressed gas cylinders from excessive heat, mechanical shocks, physical damage, slag, open flames, sparks, and arcs.
- Install cylinders in an upright position by securing to a stationary support or cylinder rack to prevent falling or tipping.
- Keep cylinders away from any welding or other electrical circuits.
- Never drape a welding torch over a gas cylinder.
- Never allow a welding electrode to touch any cylinder.

- Never weld on a pressurized cylinder—explosion will result.
- Use only correct compressed gas cylinders, regulators, hoses, and fittings designed for the specific application; maintain them and associated parts in good condition.
- Turn face away from valve outlet when opening cylinder valve. Do not stand in front of or behind the regulator when opening the valve.
- Keep protective cap in place over valve except when cylinder is in use or connected for use.
- Use the proper equipment, correct procedures, and sufficient number of persons to lift, move, and transport cylinders.
- Read and follow instructions on compressed gas cylinders, associated equipment, and Compressed Gas Association (CGA) publication P-1 listed in Safety Standards.

1-3. Additional Hazards For Installation, Operation, And Maintenance



FIRE OR EXPLOSION hazard.

- Do not install or place unit on, over, or near combustible surfaces.
- Do not install unit near flammables.
- Do not overload building wiring—be sure power supply system is properly sized, rated, and protected to handle this unit.



FALLING EQUIPMENT can injure.

- Use lifting eye to lift unit only, NOT running gear, gas cylinders, or any other accessories.
- Use correct procedures and equipment of adequate capacity to lift and support unit.
- If using lift forks to move unit, be sure forks are long enough to extend beyond opposite side of unit.
- Keep equipment (cables and cords) away from moving vehicles when working from an aerial location.
- Follow the guidelines in the Applications Manual for the Revised NIOSH Lifting Equation (Publication No. 94-110) when manually lifting heavy parts or equipment.

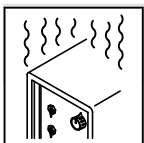

OVERUSE can cause OVERHEATING.

- Allow cooling period; follow rated duty cycle.
- Reduce current or reduce duty cycle before starting to weld again.
- Do not block or filter airflow to unit.

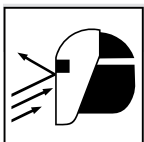

FLYING SPARKS can injure.

- Wear a face shield to protect eyes and face.
- Shape tungsten electrode only on grinder with proper guards in a safe location wearing proper face, hand, and body protection.
- Sparks can cause fires—keep flammables away.

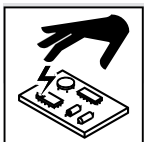

STATIC (ESD) can damage PC boards.

- Put on grounded wrist strap BEFORE handling boards or parts.
- Use proper static-proof bags and boxes to store, move, or ship PC boards.



MOVING PARTS can injure.

- Keep away from moving parts.
- Keep away from pinch points such as drive rolls.



WELDING WIRE can injure.

- Do not press gun trigger until instructed to do so.
- Do not point gun toward any part of the body, other people, or any metal when threading welding wire.

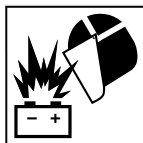

BATTERY EXPLOSION can injure.

- Do not use welder to charge batteries or jump start vehicles unless it has a battery charging feature designed for this purpose.



MOVING PARTS can injure.

- Keep away from moving parts such as fans.
- Keep all doors, panels, covers, and guards closed and securely in place.
- Have only qualified persons remove doors, panels, covers, or guards for maintenance and troubleshooting as necessary.
- Reinstall doors, panels, covers, or guards when maintenance is finished and before reconnecting input power.

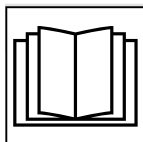

READ INSTRUCTIONS.

- Read and follow all labels and the Owner's Manual carefully before installing, operating, or servicing unit. Read the safety information at the beginning of the manual and in each section.
- Use only genuine replacement parts from the manufacturer.
- Perform installation, maintenance, and service according to the Owner's Manuals, industry standards, and national, state, and local codes.



H.F. RADIATION can cause interference.

- High-frequency (H.F.) can interfere with radio navigation, safety services, computers, and communications equipment.
- Have only qualified persons familiar with electronic equipment perform this installation.
- The user is responsible for having a qualified electrician promptly correct any interference problem resulting from the installation.
- If notified by the FCC about interference, stop using the equipment at once.
- Have the installation regularly checked and maintained.
- Keep high-frequency source doors and panels tightly shut, keep spark gaps at correct setting, and use grounding and shielding to minimize the possibility of interference.



ARC WELDING can cause interference.

- Electromagnetic energy can interfere with sensitive electronic equipment such as microprocessors, computers, and computer-driven equipment such as robots.
- Be sure all equipment in the welding area is electromagnetically compatible.

- To reduce possible interference, keep weld cables as short as possible, close together, and down low, such as on the floor.
- Locate welding operation 100 meters from any sensitive electronic equipment.
- Be sure this welding machine is installed and grounded according to this manual.
- If interference still occurs, the user must take extra measures such as moving the welding machine, using shielded cables, using line filters, or shielding the work area.

1-4. California Proposition 65 Warnings

⚠ WARNING – This product can expose you to chemicals including lead, which are known to the state of California to cause cancer and birth defects or other reproductive harm.

For more information, go to www.P65Warnings.ca.gov.

1-5. Principal Safety Standards

Safety in Welding, Cutting, and Allied Processes, American Welding Society standard ANSI Standard Z49.1. Website: <http://www.aws.org>.

Safe Practice For Occupational And Educational Eye And Face Protection, ANSI Standard Z87.1, from American National Standards Institute. Website: www.ansi.org.

Safe Practices for the Preparation of Containers and Piping for Welding and Cutting, American Welding Society Standard AWS F4.1. Website: <http://www.aws.org>.

National Electrical Code, NFPA Standard 70 from National Fire Protection Association. Website: www.nfpa.org.

Safe Handling of Compressed Gases in Cylinders, CGA Pamphlet P-1 from Compressed Gas Association. Website: www.cganet.com.

Safety in Welding, Cutting, and Allied Processes, CSA Standard W117.2 from Canadian Standards Association. Website: www.csagroup.org.

Standard for Fire Prevention During Welding, Cutting, and Other Hot Work, NFPA Standard 51B from National Fire Protection Association. Website: www.nfpa.org.

OSHA, Occupational Safety and Health Standards for General Industry, Title 29, Code of Federal Regulations (CFR), Part 1910.177 Subpart N, Part 1910 Subpart Q, and Part 1926, Subpart J. Website: www.osha.gov.

OSHA *Important Note Regarding the ACGIH TLV, Policy Statement on the Uses of TLVs and BEIs*. Website: www.osha.gov.

Applications Manual for the Revised NIOSH Lifting Equation from the National Institute for Occupational Safety and Health (NIOSH). Website: www.cdc.gov/NIOSH.

SOM 2022-01

1-6. EMF Information

Electric current flowing through any conductor causes localized electric and magnetic fields (EMF). The current from arc welding (and allied processes including spot welding, gouging, plasma arc cutting, and induction heating operations) creates an EMF field around the welding circuit. EMF fields can interfere with some medical implants, e.g. pacemakers. Protective measures for persons wearing medical implants have to be taken. For example, restrict access for passers –by or conduct individual risk assessment for welders. All welders should use the following procedures in order to minimize exposure to EMF fields from the welding circuit:

1. Keep cables close together by twisting or taping them, or using a cable cover.
2. Do not place your body between welding cables. Arrange cables to one side and away from the operator.
3. Do not coil or drape cables around your body.

4. Keep head and trunk as far away from the equipment in the welding circuit as possible.
5. Connect work clamp to workpiece as close to the weld as possible.
6. Do not work next to, sit or lean on the welding power source.
7. Do not weld whilst carrying the welding power source or wire feeder.

About Implanted Medical Devices:

Implanted Medical Device wearers should consult their doctor and the device manufacturer before performing or going near arc welding, spot welding, gouging, plasma arc cutting, or induction heating operations. If cleared by your doctor, then following the above procedures is recommended.

SECTION 2 – CONSIGNES DE SÉCURITÉ - LIRE AVANT UTILISATION

⚠ Pour écarter les risques de blessure pour vous-même et pour autrui — lire, appliquer et ranger en lieu sûr ces consignes relatives aux précautions de sécurité et au mode opératoire.

2-1. Symboles utilisés

⚠ **DANGER!** – Indique une situation dangereuse qui si on l'évite pas peut donner la mort ou des blessures graves. Les dangers possibles sont montrés par les symboles joints ou sont expliqués dans le texte.

⚠ Indique une situation dangereuse qui si on l'évite pas peut donner la mort ou des blessures graves. Les dangers possibles sont montrés par les symboles joints ou sont expliqués dans le texte.

AVIS – Indique des déclarations pas en relation avec des blessures personnelles.

 Indique des instructions spécifiques.



Ce groupe de symboles veut dire Avertissement! Attention! DANGER DE CHOC ELECTRIQUE, PIECES EN MOUVEMENT, et PIECES CHAUDES. Reportez-vous aux symboles et aux directives ci-dessous afin de connaître les mesures à prendre pour éviter tout danger.

2-2. Dangers relatifs au soudage à l'arc

⚠ Les symboles représentés ci-dessous sont utilisés dans ce manuel pour attirer l'attention et identifier les dangers possibles. En présence de ce symbole, prendre garde et suivre les instructions afférentes pour éviter tout risque. Les consignes de sécurité présentées ci-après ne font que résumer l'information contenue dans les Normes de sécurité principales. Lire et suivre toutes les Normes de sécurité.

⚠ L'installation, l'utilisation, l'entretien et les réparations ne doivent être confiés qu'à des personnes qualifiées. Une personne qualifiée est définie comme celle qui, par la possession d'un diplôme reconnu, d'un certificat ou d'un statut professionnel, ou qui, par une connaissance, une formation et une expérience approfondies, a démontré avec succès sa capacité à résoudre les problèmes liés à la tâche, le travail ou le projet et a reçu une formation en sécurité afin de reconnaître et d'éviter les risques inhérents.

⚠ Au cours de l'utilisation, tenir toute personne à l'écart et plus particulièrement les enfants.



UNE DÉCHARGE ÉLECTRIQUE peut entraîner la mort.

Le contact d'organes électriques sous tension peut provoquer des accidents mortels ou des brûlures graves. Le circuit de l'électrode et de la pièce est sous tension lorsque le courant est délivré à la sortie. Le circuit d'alimentation et les circuits internes de la machine sont également sous tension lorsque l'alimentation est sur Marche. Dans le mode de soudage avec du fil, le fil, le dérouleur, le bloc de commande du rouleau et toutes les parties métalliques en contact avec le fil sont sous tension électrique. Un équipement installé ou mis à la terre de manière incorrecte ou impropre constitue un danger.

- Ne pas toucher aux pièces électriques sous tension.
- Porter des gants isolants et des vêtements de protection secs et sans trous.
- S'isoler de la pièce à couper et du sol en utilisant des housses ou des tapis assez grands afin d'éviter tout contact physique avec la pièce à couper ou le sol.
- Ne pas utiliser de sortie de soudage CA dans des zones humides ou confinées ou s'il y a un risque de chute.
- Se servir d'une source électrique à courant électrique UNIQUEMENT si le procédé de soudage le demande.
- Si l'utilisation d'une source électrique à courant électrique s'avère nécessaire, se servir de la fonction de télécommande si l'appareil en est équipé.
- D'autres consignes de sécurité sont nécessaires dans les conditions suivantes : risques électriques dans un environnement humide ou si l'on porte des vêtements mouillés ; sur des structures

métalliques telles que sols, grilles ou échafaudages ; en position coincée comme assise, à genoux ou couchée ; ou s'il y a un risque élevé de contact inévitable ou accidentel avec la pièce à souder ou le sol. Dans ces conditions, utiliser les équipements suivants, dans l'ordre indiqué : 1) un poste à souder DC à tension constante (à fil), 2) un poste à souder DC manuel (électrode) ou 3) un poste à souder AC à tension à vide réduite. Dans la plupart des situations, l'utilisation d'un poste à souder DC à fil à tension constante est recommandée. En outre, ne pas travailler seul !

- Couper l'alimentation ou arrêter le moteur avant de procéder à l'installation, à la réparation ou à l'entretien de l'appareil. Déverrouiller l'alimentation selon la norme OSHA 29 CFR 1910.147 (voir normes de sécurité).
- Brancher correctement la mise à la terre et utiliser cet appareil conformément à son manuel d'utilisateur et aux codes nationaux, provinciaux et municipaux.
- Toujours vérifier la mise à la terre — vérifier et assurez-vous que le conducteur de mise à la terre du cordon d'alimentation est bien raccordé à la borne de mise à la terre dans le boîtier de déconnexion ou que la fiche du cordon est raccordée à une prise correctement mise à la terre.
- En effectuant les raccordements d'entrée, fixer d'abord le conducteur de mise à la terre approprié et contre-vérifier les connexions.
- Les câbles doivent être exempts d'humidité, d'huile et de graisse; protégez-les contre les étincelles et les pièces métalliques chaudes.
- Vérifier fréquemment le cordon d'alimentation et le conducteur de mise à la terre afin de s'assurer qu'il n'est pas altéré ou dénudé -, le remplacer immédiatement s'il l'est -. Un fil dénudé peut entraîner la mort.
- L'équipement doit être hors tension lorsqu'il n'est pas utilisé.
- Ne pas utiliser des câbles usés, endommagés, de grosseur insuffisante ou mal épissés.
- Ne pas enrouler les câbles autour du corps.
- Si la pièce soudée doit être mise à la terre, le faire directement avec un câble distinct.
- Ne pas toucher l'électrode quand on est en contact avec la pièce, la terre ou une électrode provenant d'une autre machine.
- Ne pas toucher des porte électrodes connectés à deux machines en même temps à cause de la présence d'une tension à vide doublée.
- N'utiliser qu'un matériel en bon état. Réparer ou remplacer sur-le-champ les pièces endommagées. Entretenir l'appareil conformément à ce manuel.
- Porter un harnais de sécurité si l'on doit travailler au-dessus du sol.

- S'assurer que tous les panneaux et couvercles sont correctement en place.
- Fixer le câble de retour de façon à obtenir un bon contact métal-métal avec la pièce à souder ou la table de travail, le plus près possible de la soudure.
- Isoler la pince de masse quand pas mis à la pièce pour éviter le contact avec tout objet métallique.
- Ne pas raccorder plus d'une électrode ou plus d'un câble de masse à une même borne de sortie de soudage. Débrancher le câble pour le procédé non utilisé.
- Utiliser une protection différentielle lors de l'utilisation d'un équipement auxiliaire dans des endroits humides ou mouillés.



LES PIÈCES CHAUDES peuvent provoquer des brûlures.

- Ne pas toucher des parties chaudes à mains nues.
- Prévoir une période de refroidissement avant de travailler à l'équipement.
- Ne pas toucher aux pièces chaudes, utiliser les outils recommandés et porter des gants de soudage et des vêtements épais pour éviter les brûlures.

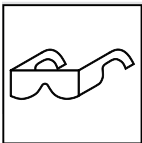

DES PIÈCES DE METAL ou DES SALETES peuvent provoquer des blessures dans les yeux.

- Le soudage, l'écaillage, le passage de la pièce à la brosse en fil de fer, et le meulage génèrent des étincelles et des particules métalliques volantes. Pendant la période de refroidissement des soudures, elles risquent de projeter du laitier.
- Porter des lunettes de sécurité avec écrans latéraux ou un écran facial.



LES FUMÉES ET LES GAZ peuvent être dangereux.

Le soudage génère des fumées et des gaz. Leur inhalation peut être dangereuse pour votre santé.

- Eloigner votre tête des fumées. Ne pas respirer les fumées.
- À l'intérieur, ventiler la zone et/ou utiliser une ventilation forcée au niveau de l'arc pour l'évacuation des fumées et des gaz de soudage. Pour déterminer la bonne ventilation, il est recommandé de procéder à un prélèvement pour la composition et la quantité de fumées et de gaz auxquelles est exposé le personnel.
- Si la ventilation est médiocre, porter un respirateur anti-vapeurs approuvé.
- Lire et comprendre les fiches de données de sécurité et les instructions du fabricant concernant les adhésifs, les revêtements, les nettoyants, les consommables, les produits de refroidissement, les dégraissants, les flux et les métaux.
- Travailler dans un espace fermé seulement s'il est bien ventilé ou en portant un respirateur à alimentation d'air. Demander toujours à un surveillant dûment formé de se tenir à proximité. Des fumées et des gaz de soudage peuvent déplacer l'air et abaisser le niveau d'oxygène provoquant des blessures ou des accidents mortels. S'assurer que l'air de respiration ne présente aucun danger.
- Ne pas souder dans des endroits situés à proximité d'opérations de dégraissage, de nettoyage ou de pulvérisation. La chaleur et les rayons de l'arc peuvent réagir en présence de vapeurs et former des gaz hautement toxiques et irritants.
- Ne pas souder des métaux munis d'un revêtement, tels que l'acier galvanisé, plaqué en plomb ou au cadmium à moins que le revêtement n'ait été enlevé dans la zone de soudure, que l'endroit soit bien ventilé, et en portant un respirateur à alimentation d'air. Les revêtements et tous les métaux renfermant ces éléments peuvent dégager des fumées toxiques en cas de soudage.



LES ACCUMULATIONS DE GAZ risquent de provoquer des blessures ou même la mort.

- Fermer l'alimentation du gaz comprimé en cas de non utilisation.
- Veiller toujours à bien aérer les espaces confinés ou se servir d'un respirateur d'adduction d'air homologué.

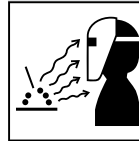

LES RAYONS DE L'ARC peuvent provoquer des brûlures dans les yeux et sur la peau.

Le rayonnement de l'arc du procédé de soudage génère des rayons visibles et invisibles intenses (ultraviolets et infrarouges) susceptibles de provoquer des brûlures dans les yeux et sur la peau. Des étincelles sont projetées pendant le soudage.

- Porter un casque de soudage approuvé muni de verres filtrants approprié pour protéger visage et yeux pendant le soudage (voir ANSI Z49.1 et Z87.1 énuméré dans les normes de sécurité).
- Porter des lunettes de sécurité avec écrans latéraux même sous votre casque.
- Avoir recours à des écrans protecteurs ou à des rideaux pour protéger les autres contre les rayonnements les éblouissements et les étincelles ; prévenir toute personne sur les lieux de ne pas regarder l'arc.
- Porter une protection corporelle en cuir ou des vêtements ignifuges (FRC). La protection du corps comporte des vêtements sans huile, comme des gants de cuir, une chemise solide, des pantalons sans revers, des chaussures hautes et une casquette.



LE SOUDAGE peut provoquer un incendie ou une explosion.

Le soudage effectué sur des conteneurs fermés tels que des réservoirs, tambours ou des conduites peut provoquer leur éclatement. Des étincelles peuvent être projetées de l'arc de soudure. La projection d'étincelles, des pièces chaudes et des équipements chauds peut provoquer des incendies et des brûlures. Le contact accidentel de l'électrode avec des objets métalliques peut provoquer des étincelles, une explosion, un surchauffement ou un incendie. Avant de commencer le soudage, vérifier et s'assurer que l'endroit ne présente pas de danger.

- Déplacer toutes les substances inflammables à une distance de 10,7 m de l'arc de soudage. En cas d'impossibilité les recouvrir soigneusement avec des protections homologuées.
- Ne pas souder dans un endroit où des étincelles peuvent tomber sur des substances inflammables.
- Se protéger et d'autres personnes de la projection d'étincelles et de métal chaud.
- Des étincelles et des matériaux chauds du soudage peuvent facilement passer dans d'autres zones en traversant de petites fissures et des ouvertures.
- Surveiller tout déclenchement d'incendie et tenir un extincteur à proximité.
- Le soudage effectué sur un plafond, plancher, paroi ou séparation peut déclencher un incendie de l'autre côté.
- Ne pas couper ou souder des jantes ou des roues. Les pneus peuvent exploser s'ils sont chauffés. Les jantes et les roues réparées peuvent défailir. Voir OSHA 29 CFR 1910.177 énuméré dans les normes de sécurité.
- Ne pas effectuer le soudage sur des conteneurs fermés tels que des réservoirs, tambours, ou conduites, à moins qu'ils n'aient été préparés correctement conformément à AWS F4.1 (voir les Normes de Sécurité).
- Ne pas souder là où l'air ambiant pourrait contenir des poussières, gaz ou émanations inflammables (vapeur d'essence, par exemple).

- Brancher le câble de masse sur la pièce le plus près possible de la zone de soudage pour éviter le transport du courant sur une longue distance par des chemins inconnus éventuels en provoquant des risques d'électrocution, d'étincelles et d'incendie.
- Ne pas utiliser le poste de soudage pour dégeler des conduites gelées.
- En cas de non utilisation, enlever la baguette d'électrode du porte-électrode ou couper le fil à la pointe de contact.
- Porter une protection corporelle en cuir ou des vêtements ignifuges (FRC). La protection du corps comporte des vêtements sans huile, comme des gants de cuir, une chemise solide, des pantalons sans revers, des chaussures hautes et une casquette.
- Avant de souder, retirer toute substance combustible de vos poches telles qu'un allumeur au butane ou des allumettes.
- Une fois le travail achevé, assurez-vous qu'il ne reste aucune trace d'étincelles incandescentes ni de flammes.
- Utiliser exclusivement des fusibles ou coupe-circuits appropriés. Ne pas augmenter leur puissance; ne pas les ponter.
- Suivre les recommandations dans OSHA 1910.252 (a) (2) (iv) et NFPA 51B pour les travaux à chaud et avoir de la surveillance et un extincteur à proximité.
- Lire et comprendre les fiches de données de sécurité et les instructions du fabricant concernant les adhésifs, les revêtements, les nettoyeurs, les consommables, les produits de refroidissement, les dégraisseurs, les flux et les métaux.

- Les porteurs d'implants médicaux doivent consulter leur médecin et le fabricant du dispositif avant de s'approcher de la zone où se déroule du soudage à l'arc, du soudage par points, du gougeage, de la découpe plasma ou une opération de chauffage par induction.

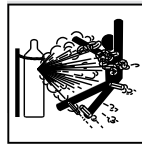

Si des BOUTEILLES sont endommagées, elles pourront exploser.

Des bouteilles de gaz comprimé protecteur contiennent du gaz sous haute pression. Si une bouteille est endommagée, elle peut exploser. Du fait que les bouteilles de gaz font normalement partie du procédé de soudage, les manipuler avec précaution.

- Protéger les bouteilles de gaz comprimé d'une chaleur excessive, des chocs mécaniques, des dommages physiques, du laitier, des flammes ouvertes, des étincelles et des arcs.
- Placer les bouteilles debout en les fixant dans un support stationnaire ou dans un porte-bouteilles pour les empêcher de tomber ou de se renverser.
- Tenir les bouteilles éloignées des circuits de soudage ou autres circuits électriques.
- Ne jamais placer une torche de soudage sur une bouteille à gaz.
- Une électrode de soudage ne doit jamais entrer en contact avec une bouteille.
- Ne jamais souder une bouteille pressurisée - risque d'explosion.
- Utiliser seulement des bouteilles de gaz comprimé, régulateurs, tuyaux et raccords convenables pour cette application spécifique; les maintenir ainsi que les éléments associés en bon état.
- Tourner le dos à la sortie de vanne lors de l'ouverture de la vanne de la bouteille. Ne pas se tenir devant ou derrière le régulateur lors de l'ouverture de la vanne.
- Maintenir le chapeau de protection sur la soupape, sauf en cas d'utilisation ou de branchement de la bouteille.
- Utilisez les équipements corrects, les bonnes procédures et suffisamment de personnes pour soulever, déplacer et transporter les bouteilles.
- Lire et suivre les instructions sur les bouteilles de gaz comprimé, l'équipement connexe et le dépliant P-1 de la CGA (Compressed Gas Association) mentionné dans les principales normes de sécurité.



Le BRUIT peut endommager l'ouïe.

Le bruit des processus et des équipements peut affecter l'ouïe.

- Porter des protections approuvées pour les oreilles si le niveau sonore est trop élevé.



Les CHAMPS ÉLECTROMAGNÉTIQUES (CEM) peuvent affecter les implants médicaux.

- Les porteurs de stimulateurs cardiaques et autres implants médicaux doivent rester à distance.

2-3. Symboles de dangers supplémentaires en relation avec l'installation, le fonctionnement et la maintenance



Risque D'INCENDIE OU D'EXPLOSION.

- Ne pas placer l'appareil sur, au-dessus ou à proximité de surfaces inflammables.
- Ne pas installer l'appareil à proximité de produits inflammables
- Ne pas surcharger l'installation électrique – s'assurer que l'alimentation est correctement dimensionnée et protégée avant de mettre l'appareil en service.

- Tenir l'équipement (câbles et cordons) à distance des véhicules mobiles lors de toute opération en hauteur.
- Suivre les consignes du Manuel des applications pour l'équation de levage NIOSH révisée (Publication N°94-110) lors du levage manuel de pièces ou équipements lourds.

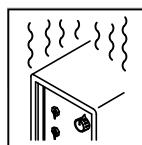

L'EMPLOI EXCESSIF peut SURCHAUFFER L'ÉQUIPEMENT.

- Laisser l'équipement refroidir; respecter le facteur de marche nominal.
- Réduire le courant ou le cycle opératoire avant de recommencer le soudage.
- Ne pas obstruer les passages d'air du poste.



LA CHUTE DE L'ÉQUIPEMENT peut provoquer des blessures.

- Utiliser l'anneau de levage uniquement pour soulever l'appareil, NON PAS les organes de roulement, les bouteilles de gaz ou tout autre accessoire.
- Utilisez les procédures correctes et des équipements d'une capacité appropriée pour soulever et supporter l'appareil.
- En utilisant des fourches de levage pour déplacer l'unité, s'assurer que les fourches sont suffisamment longues pour dépasser du côté opposé de l'appareil.

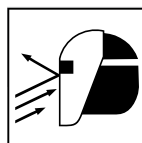

LES ÉTINCELLES PROJÉTÉES peuvent provoquer des blessures.

- Porter un écran facial pour protéger le visage et les yeux.

- Affûter l'électrode au tungstène uniquement à la meuleuse dotée de protecteurs. Cette manœuvre est à exécuter dans un endroit sûr lorsque l'on porte l'équipement homologué de protection du visage, des mains et du corps.
- Les étincelles risquent de causer un incendie - éloigner toute substance inflammable.

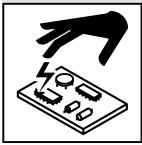

LES CHARGES ÉLECTROSTATIQUES peuvent endommager les circuits imprimés.

- Établir la connexion avec la barrette de terre AVANT de manipuler des cartes ou des pièces.
- Utiliser des pochettes et des boîtes antistatiques pour stocker, déplacer ou expédier des cartes de circuits imprimés.



Les PIÈCES MOBILES peuvent causer des blessures.

- Ne pas s'approcher des organes mobiles.
- Ne pas s'approcher des points de coincement tels que des rouleaux de commande.



LES FILS DE SOUDAGE peuvent provoquer des blessures.

- Ne pas appuyer sur la gachette avant d'en avoir reçu l'instruction.
- Ne pas diriger le pistolet vers soi, d'autres personnes ou toute pièce mécanique en engageant le fil de soudage.



L'EXPLOSION DE LA BATTERIE peut provoquer des blessures.

- Ne pas utiliser l'appareil de soudage pour charger des batteries ou faire démarrer des véhicules à l'aide de câbles de démarrage, sauf si l'appareil dispose d'une fonctionnalité de charge de batterie destinée à cet usage.



Les PIÈCES MOBILES peuvent causer des blessures.

- S'abstenir de toucher des organes mobiles tels que des ventilateurs.
- Maintenir fermés et verrouillés les portes, panneaux, recouvrements et dispositifs de protection.
- Lorsque cela est nécessaire pour des travaux d'entretien et de dépannage, faire retirer les portes, panneaux, recouvrements ou dispositifs de protection uniquement par du personnel qualifié.
- Remettre les portes, panneaux, recouvrements ou dispositifs de protection quand l'entretien est terminé et avant de rebrancher l'alimentation électrique.

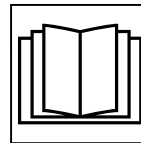

LIRE LES INSTRUCTIONS.

- Lire et appliquer les instructions sur les étiquettes et le Mode d'emploi avant l'installation, l'utilisation ou l'entretien de l'appareil. Lire les informations de sécurité au début du manuel et dans chaque

section.

- N'utiliser que des pièces de remplacement provenant du fabricant.
- Effectuer l'installation, l'entretien et toute intervention selon les manuels d'utilisateurs, les normes nationales, provinciales et de l'industrie, ainsi que les codes municipaux.

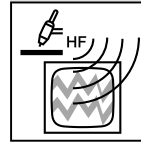

LE RAYONNEMENT HAUTE FRÉQUENCE (H.F.) risque de provoquer des interférences.

- Le rayonnement haute fréquence (H.F.) peut provoquer des interférences avec les équipements de radio-navigation et de communication, les services de sécurité et les ordinateurs.
- Demander seulement à des personnes qualifiées familiarisées avec des équipements électroniques de faire fonctionner l'installation.
- L'utilisateur est tenu de faire corriger rapidement par un électricien qualifié les interférences résultant de l'installation.
- Si le FCC signale des interférences, arrêter immédiatement l'appareil.
- Effectuer régulièrement le contrôle et l'entretien de l'installation.
- Maintenir soigneusement fermés les portes et les panneaux des sources de haute fréquence, maintenir les éclateurs à une distance correcte et utiliser une terre et un blindage pour réduire les interférences éventuelles.

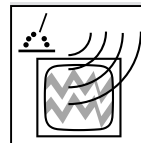

LE SOUDAGE À L'ARC risque de provoquer des interférences.

- L'énergie électromagnétique risque de provoquer des interférences pour l'équipement électronique sensible tel que les ordinateurs et l'équipement commandé par ordinateur tel que les robots.
- Veiller à ce que tout l'équipement de la zone de soudage soit compatible électromagnétiquement.
- Pour réduire la possibilité d'interférence, maintenir les câbles de soudage aussi courts que possible, les grouper, et les poser aussi bas que possible (ex. par terre).
- Veiller à souder à une distance de 100 mètres de tout équipement électronique sensible.
- Veiller à ce que ce poste de soudage soit posé et mis à la terre conformément à ce mode d'emploi.
- En cas d'interférences après avoir pris les mesures précédentes, il incombe à l'utilisateur de prendre des mesures supplémentaires telles que le déplacement du poste, l'utilisation de câbles blindés, l'utilisation de filtres de ligne ou la pose de protecteurs dans la zone de travail.

2-4. Proposition californienne 65 Avertissements

⚠ AVERTISSEMENT – Ce produit peut vous exposer à des produits chimiques tels que le plomb, reconnus par l'État de Californie comme cancérigènes et sources de malformations ou d'autres troubles de la reproduction.

Pour plus d'informations, consulter www.P65Warnings.ca.gov.

2-5. Principales normes de sécurité

Safety in Welding, Cutting, and Allied Processes, American Welding Society standard ANSI Standard Z49.1. Website: <http://www.aws.org>.

Safe Practice For Occupational And Educational Eye And Face Protection, ANSI Standard Z87.1, from American National Standards Institute. Website: www.ansi.org.

Safe Practices for the Preparation of Containers and Piping for Welding and Cutting, American Welding Society Standard AWS F4.1. Website: <http://www.aws.org>.

National Electrical Code, NFPA Standard 70 from National Fire Protection Association. Website: www.nfpa.org.

Safe Handling of Compressed Gases in Cylinders, CGA Pamphlet P-1 from Compressed Gas Association. Website: www.cganet.com.

Safety in Welding, Cutting, and Allied Processes, CSA Standard W117.2 from Canadian Standards Association. Website: www.csa-group.org.

Standard for Fire Prevention During Welding, Cutting, and Other Hot Work, NFPA Standard 51B from National Fire Protection Association. Website: www.nfpa.org.

OSHA, Occupational Safety and Health Standards for General Industry, Title 29, Code of Federal Regulations (CFR), Part 1910.177

Subpart N, Part 1910 Subpart Q, and Part 1926, Subpart J. Website: www.osha.gov.

OSHA Important Note Regarding the ACGIH TLV, Policy Statement on the Uses of TLVs and BEIs. Website: www.osha.gov.

Applications Manual for the Revised NIOSH Lifting Equation from the National Institute for Occupational Safety and Health (NIOSH). Website: www.cdc.gov/NIOSH.

SOM_fre 2022-01

2-6. Informations relatives aux CEM

Le courant électrique qui traverse tout conducteur génère des champs électromagnétiques (CEM) à certains endroits. Le courant issu d'un soudage à l'arc (et de procédés connexes, y compris le soudage par points, le gougeage, le découpage plasma et les opérations de chauffage par induction) crée un champ électromagnétique (CEM) autour du circuit de soudage. Les champs électromagnétiques produits peuvent causer interférence à certains implants médicaux, p. ex. les stimulateurs cardiaques. Des mesures de protection pour les porteurs d'implants médicaux doivent être prises: par exemple, des restrictions d'accès pour les passants ou une évaluation individuelle des risques pour les soudeurs. Tous les soudeurs doivent appliquer les procédures suivantes pour minimiser l'exposition aux CEM provenant du circuit de soudage:

1. Rassembler les câbles en les torsadant ou en les attachant avec du ruban adhésif ou avec une housse.
2. Ne pas se tenir au milieu des câbles de soudage. Disposer les câbles d'un côté et à distance de l'opérateur.

3. Ne pas courber et ne pas entourer les câbles autour de votre corps.
4. Maintenir la tête et le torse aussi loin que possible du matériel du circuit de soudage.
5. Connecter la pince sur la pièce aussi près que possible de la soudure.
6. Ne pas travailler à proximité d'une source de soudage, ni s'asseoir ou se pencher dessus.
7. Ne pas souder tout en portant la source de soudage ou le dévidoir.









En ce qui concerne les implants médicaux :



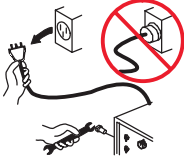

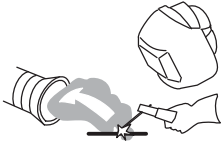

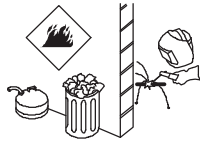

Les porteurs d'implants doivent d'abord consulter leur médecin avant de s'approcher des opérations de soudage à l'arc, de soudage par points, de gougeage, du coupage plasma ou de chauffage par induction. Si le médecin approuve, il est recommandé de suivre les procédures précédentes.

SECTION 3 – DEFINITIONS

3-1. Additional Safety Symbol Definitions

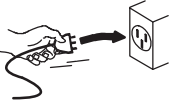
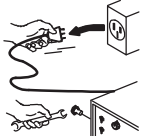
☞ Some symbols are found only on CE products.

	<p>Warning! Watch Out! There are possible hazards as shown by the symbols.</p>
	<p>Wear dry insulating gloves. Do not touch electrode with bare hand. Do not wear wet or damaged gloves.</p>
	<p>Protect yourself from electric shock by insulating yourself from work and ground.</p>
	<p>Disconnect input plug or power before working on machine.</p>
	<p>Keep your head out of the fumes.</p>
	<p>Use forced ventilation or local exhaust to remove the fumes.</p>
	<p>Use ventilating fan to remove fumes.</p>
	<p>Keep flammables away from welding. Do not weld near flammables.</p>
	<p>Welding sparks can cause fires. Have a fire extinguisher nearby, and have a watchperson ready to use it.</p>





	<p>Do not weld on drums or any closed containers.</p>
	<p>Do not remove or paint over (cover) the label.</p>
	<p>When power is applied failed parts can explode or cause other parts to explode.</p>
	<p>Flying pieces of parts can cause injury. Always wear a face shield when servicing unit.</p>
	<p>Always wear long sleeves and button your collar when servicing unit.</p>
	<p>After taking proper precautions as shown, connect power to unit.</p>
	<p>Disconnect input plug or power before working on machine.</p>
	<p>Do not use one handle to lift or support unit.</p>
	<p>Do not discard product (where applicable) with general waste. Reuse or recycle Waste Electrical and Electronic Equipment (WEEE) by disposing at a designated collection facility. Contact your local recycling office or your local distributor for further information.</p>
	<p>Environmental Protection Use Period (China)</p>











	<p>Wear hat and safety glasses. Use ear protection and button shirt collar. Use welding helmet with correct shade of filter. Wear complete body protection made from leather or flame-resistant clothing (FRC). Body protection includes oil-free clothing such as leather gloves, heavy shirt, cuffless trousers, high shoes, and a cap.</p>
	<p>Become trained and read the instructions before working on the machine or welding.</p>
	<p>Hazardous voltage remains on input capacitors after power is turned off. Do not touch fully charged capacitors. Always wait 60 seconds after power is turned off before working on unit, AND check input capacitor voltage, and be sure it is near 0 before touching any parts.</p>
	<p>Always lift and support unit using both handles. Keep angle of lifting device less than 60 degrees. Use a proper cart to move unit.</p>
	<p>Welding current creates an electric and magnetic field (EMF) around the welding circuit and welding equipment.</p>











3-2. Miscellaneous Symbols And Definitions

☞ Some symbols are found only on CE products.

	<p>Amperage</p>		<p>Arc Striking with Contact (Lift-Arc)</p>		<p>Alternating Current (AC)</p>
	<p>Output</p>		<p>Gas Postflow</p>		<p>Gas Input</p>
	<p>Gas Tungsten Arc Welding (GTAW)</p>		<p>Gas Preflow</p>		<p>Gas Output</p>
	<p>Voltage</p>		<p>Seconds</p>		<p>Rated Welding Current</p>
	<p>Input Voltage</p>		<p>On</p>		<p>Duty Cycle</p>
	<p>Output Voltage</p>		<p>Off</p>		<p>Direct Current (DC)</p>
	<p>Circuit Breaker</p>		<p>Positive</p>		<p>Line Connection</p>
	<p>Remote</p>		<p>Negative</p>		<p>Conventional Load Voltage</p>

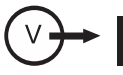
U₁	Primary Voltage
IP	Degree of Protection
I_{1max}	Rated Maximum Supply Current
I_{1eff}	Maximum Effective Supply Current
U₀	Rated No Load Voltage (OCV)
	Initial Amperage
	Increase/Decrease Of Quantity
%	Percent
Hz	Hertz
	Arc Force (DIG)
	Arc Striking without Contact (HF And Impulse)

	Final Slope
	Final Amperage
	Pulse Percent On Time
	Initial Slope
	Pulse
	Pulse Frequency
	Process (Welding)
	Suitable for Welding in an Environment with Increased Risk of Electric Shock
	Process Cycle
	Percent of Background Amperage

	Panel/Local
	Shielded Metal Arc Welding (SMAW)
	Protective Earth (Ground)
	Pulse Background Amperage
	Normal Trigger Operation (GTAW)
	Two-Step Trigger Operation (GTAW)
	Four-Step Trigger Operation (GTAW)
	Contactor Control (Stick)
	Pulser On-Off
	TIG Weld Amps And Peak Amps While Pulsing
	Press to Set

SECTION 4 – SPECIFICATIONS

4-1. Serial Number And Rating Label Location

The serial number and rating information for the power source is located on the top of the machine. Use the rating labels to determine input power requirements and/or rated output. For future reference, write serial number in space provided on back cover of this manual.

4-2. Software Licensing Agreement

The End User License Agreement and any third-party notices and terms and conditions pertaining to third-party software can be found at <https://www.millerwelds.com/eula> and are incorporated by reference herein.

4-3. Information About Default Weld Parameters And Settings

NOTICE – Each welding application is unique. Although certain Miller Electric products are designed to determine and default to certain typical welding parameters and settings based upon specific and relatively limited application variables input by the end user, such default settings are for reference purposes only; and final weld results can be affected by other variables and application-specific circumstances. The appropriateness of all parameters and settings should be evaluated and modified by the end user as necessary based upon application-specific requirements. The end user is solely responsible for selection and coordination of appropriate equipment, adoption or adjustment of default weld parameters and settings, and ultimate quality and durability of all resultant welds. Miller Electric expressly disclaims any and all implied warranties including any implied warranty of fitness for a particular purpose.

4-4. Specifications

 This equipment will deliver rated output at an ambient air temperature up to 104° F (40° C).

 Do not use information in unit specifications table to determine electrical service requirements. See Sections 5-6, 5-7, 5-8 and 5-9 for information on connecting input power.

Welding Amperage Range	Max Open-Circuit Voltage (U ₀)	Low Open-Circuit Voltage (U ₀)	Rated Peak Striking Voltage (U _p)
1-210 ¹	80	8-15 ²	15KV ³

¹ Welding range for Stick process is 5-210 amperes. For TIG, the amperage range is tungsten diameter dependent (see Section 6-6) dependent on model.

² Low open-circuit voltage while in TIG Lift Arc[®], or while in Stick with low open-circuit voltage selected.

³ Arc starting device is designed for manual guided operations.

Process	Output Ratings			Phase	Current Draw (A) At Rated Input Voltages (V)				
	Current (A)	Voltage (V)	Duty Cycle		120V	208V	240V	400V	480V
STICK	210	28.4	30%	1	—	39	33	20	16
				3	—	22	19	12	10
	160	26.4	60%	1	—	28	24	14	12
				3	—	16	14	9	8
	125	25	100%	1	—	21	18	11	9
				3	—	12	10	7	6
	100	24	40%	1	30	—	—	—	—
90	23.6	60%	1	27	—	—	—	—	
75	23	100%	1	22	—	—	—	—	
TIG	210	18.4	60%	1	—	28	23	14	12
				3	—	16	13	8	7
	175	17	100%	1	—	22	18	11	9
				3	—	12	10	7	6
	150	16	40%	1	32	—	—	—	—
	125	15	60%	1	26	—	—	—	—
	100	14	100%	1	20	—	—	—	—
3				—	13	14	28	39	

4-5. Dimensions, Weights, And Mounting Options

A. Welding Power Source

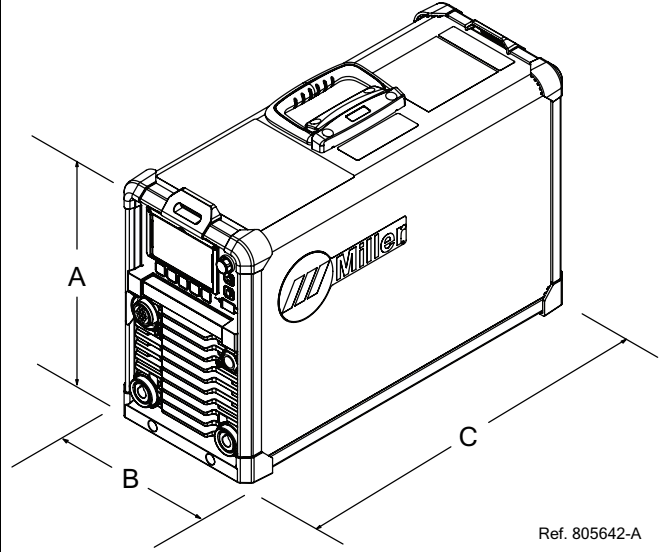
	Dimensions	
	A	13-7/8 in. (352 mm)
B	8-1/2 in. (216 mm)	
C	21-7/8 in. (555 mm)	
Weight	47 lb (21.3 kg) Dynasty w/CPS: 50 lb (22.7 kg)	
Strap / handle weight rating: 57 lb (26 kg) [see Section 5-1]		

B. Welding Power Source With Cart And Cooler

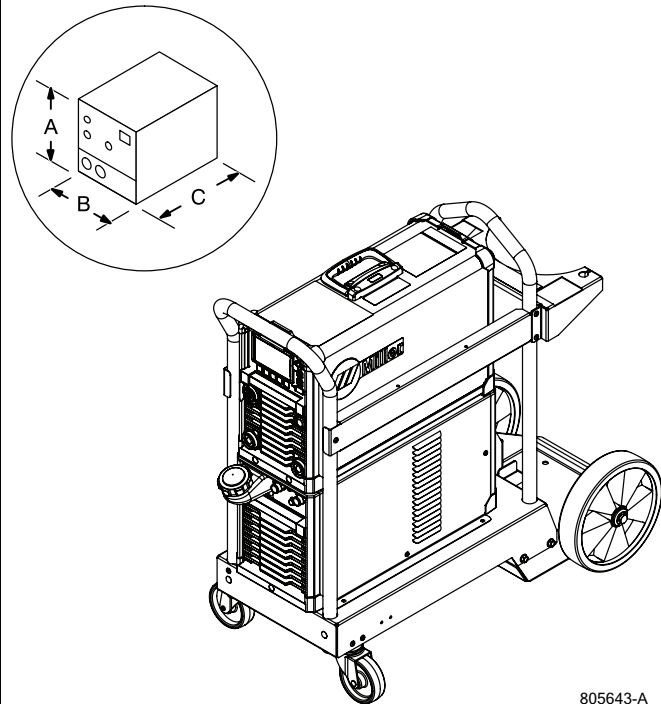
	Dimensions	
	A	34-3/4 in. (883 mm)
B	19-1/2 in. (493 mm)	
C	39-1/2 in. (1003 mm)	
Weight (Empty)	142 lb (64 kg)	
Cart lift point weight rating: 240 lb (109 kg) [see Section 5-1]		

C. Mounting Options

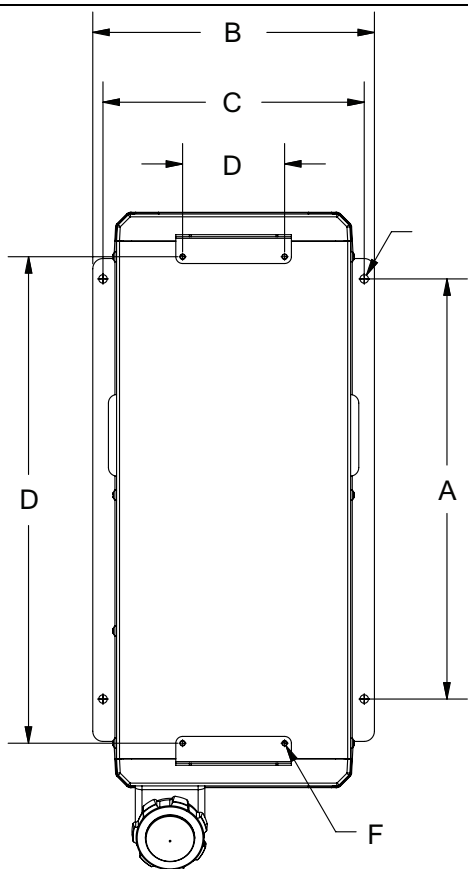

Dimensions	
A	15-7/16 in. (392 mm)
B	9-19/32 in. (244 mm) Center-To-Center
C	5/16 in. (8 mm)
D	17-7/8 in. (454 mm)
E	3-3/4 in. (95 mm)
F	13/64 in. (5 mm)

1 Mounting Hardware

Remove hardware to separate power source from cooler.

Reinstall hardware.

2 Mounting Brackets

Use brackets to mount power source to cooler. Bracket is included with cooler.

Mounting bracket may be purchased separately to mount machine to another surface. Space bracket according to dimensions shown.

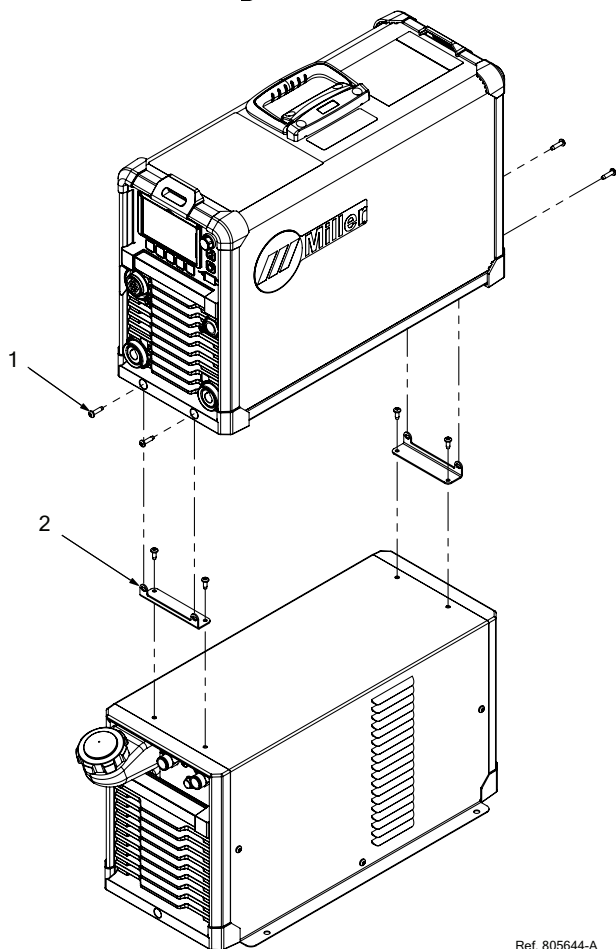

Ref. 805644-A

4-6. Static Characteristics

The static (output) characteristics of the welding power source can be described as *drooping* during the SMAW and GTAW processes. Static characteristics are also affected by control settings (including software), electrode, shielding gas, weldment material, and other factors. Contact the factory for specific information on the static characteristics of the welding power source.

4-7. Environmental Specifications

A. IP Rating

IP Rating
IP23 This equipment is designed for outdoor use.

B. Temperature Specifications

Operating Temperature Range*	Storage/Transportation Temperature Range
14 to 104°F (-10 to 40°C)	-4 to 131°F (-20 to 55°C)

*Output is derated at temperatures above 104°F (40°C).

C. Information On Electromagnetic Compatibility (EMC)

<p>⚠ This Class A equipment is not intended for use in residential locations where the electrical power is provided by the public low-voltage supply system. There can be potential difficulties in ensuring electromagnetic compatibility in those locations, due to conducted as well as radiated disturbances.</p> <p>This equipment complies with IEC61000-3-11 and IEC 61000-3-12 and can be connected to public low-voltage systems provided that the public low-voltage system impedance Z_{max} at the point of common coupling is less than 78mΩ (or the short-circuit power S_{sc} is greater than 2.1MVA). It is the responsibility of the installer or user of the equipment to ensure, by consultation with the distribution network operator if necessary, that the system impedance complies with the impedance restrictions.</p>

D. China EEP Hazardous Substance Information

中国电器电子产品中有害物质的名称及含量 China EEP Hazardous Substance Information						
部件名称 Component Name (如果适用) (if applicable)	有害物质 Hazardous Substance					
	铅 Pb	汞 Hg	镉 Cd	六价铬 Cr6	多溴联苯 PBB	多溴二苯醚 PBDE
黄铜和铜部件 Brass and Copper Parts	X	O	O	O	O	O
耦合装置 Coupling Devices	X	O	O	O	O	O
开关装置 Switching Devices	O	O	X	O	O	O
线缆和线缆配件 Cable and Cable Accessories	X	O	O	O	O	O
电池 Batteries	X	O	O	O	O	O
本表格依据中国SJ/T 11364的规定编制。 This table is prepared in accordance with China SJ/T 11364.						
O: 表示该有害物质在该部件所有均质材料中的含量均在中国GB/T26572规定的限量要求以下。 Indicates that the concentration of the Hazardous Substance in all homogeneous materials of the part is below the relevant threshold of China GB/T 26572.						
X: 表示该有害物质至少在该部件的某一均质材料中的含量超出中国GB/T26572规定的限量要求。 Indicates that the concentration of the Hazardous Substance in at least one homogeneous material of the part is above the relevant threshold of China GB/T 26572.						
器电子产品的环保使用期限依据中国SJ/Z11388的规定确定。 The EFUP value of this EEP is defined in accordance with China SJ/Z 11388.						

E. EU Ecodesign Information

Model	Input	Minimum Power Source Efficiency	Maximum Idle State Power Consumption
Dynasty 210	400V Three Phase	82.4%	27.8W
Dynasty 210	230V Three Phase	80.3%	27.3W

	<p>Do not discard product (where applicable) with general waste. Reuse or recycle Waste Electrical and Electronic Equipment (WEEE) by disposing at a designated collection facility. Contact your local recycling office or your local distributor for further information.</p>
---	---

Critical raw materials possibly present in indicative amounts higher than 1 gram at component level	
Component	Critical Raw Material
Printed circuit boards	Baryte, Bismuth, Cobalt, Gallium, Germanium, Hafnium, Indium, Heavy Rare Earth, Light Rare Earth, Niobium, Platinum Group Metals, Scandium, Silicon Metal, Tantalum, Vanadium
Plastic components	Antimony, Baryte
Electrical and electronic components	Antimony, Beryllium, Magnesium
Metal components	Beryllium, Cobalt, Magnesium, Tungsten, Vanadium
Cables and cable assemblies	Borate, Antimony, Baryte, Beryllium, Magnesium
Display panels	Gallium, Indium, Heavy Rare Earth, Light Rare Earth, Niobium, Platinum Group Metals, Scandium
Batteries	Fluorspar, Heavy Rare Earth, Light Rare Earth, Magnesium

4-8. Duty Cycle And Overheating



Duty Cycle is percentage of 10 minutes that unit can weld at rated load without overheating.

If unit overheats, output stops, a error message is displayed, and cooling fan runs. Wait fifteen minutes for unit to cool. Reduce amperage or voltage, or duty cycle before welding.

NOTICE – Exceeding duty cycle can damage machine or torch and void warranty.

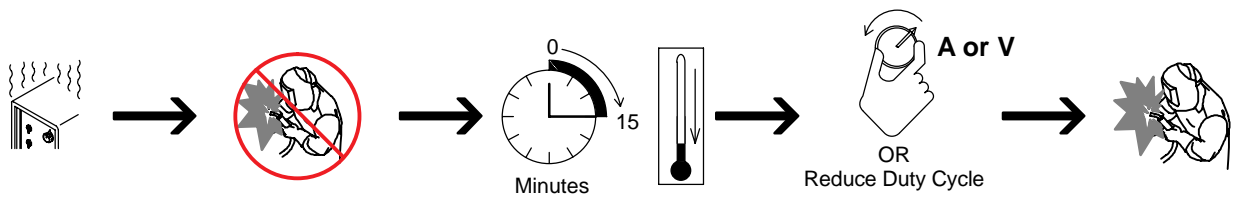
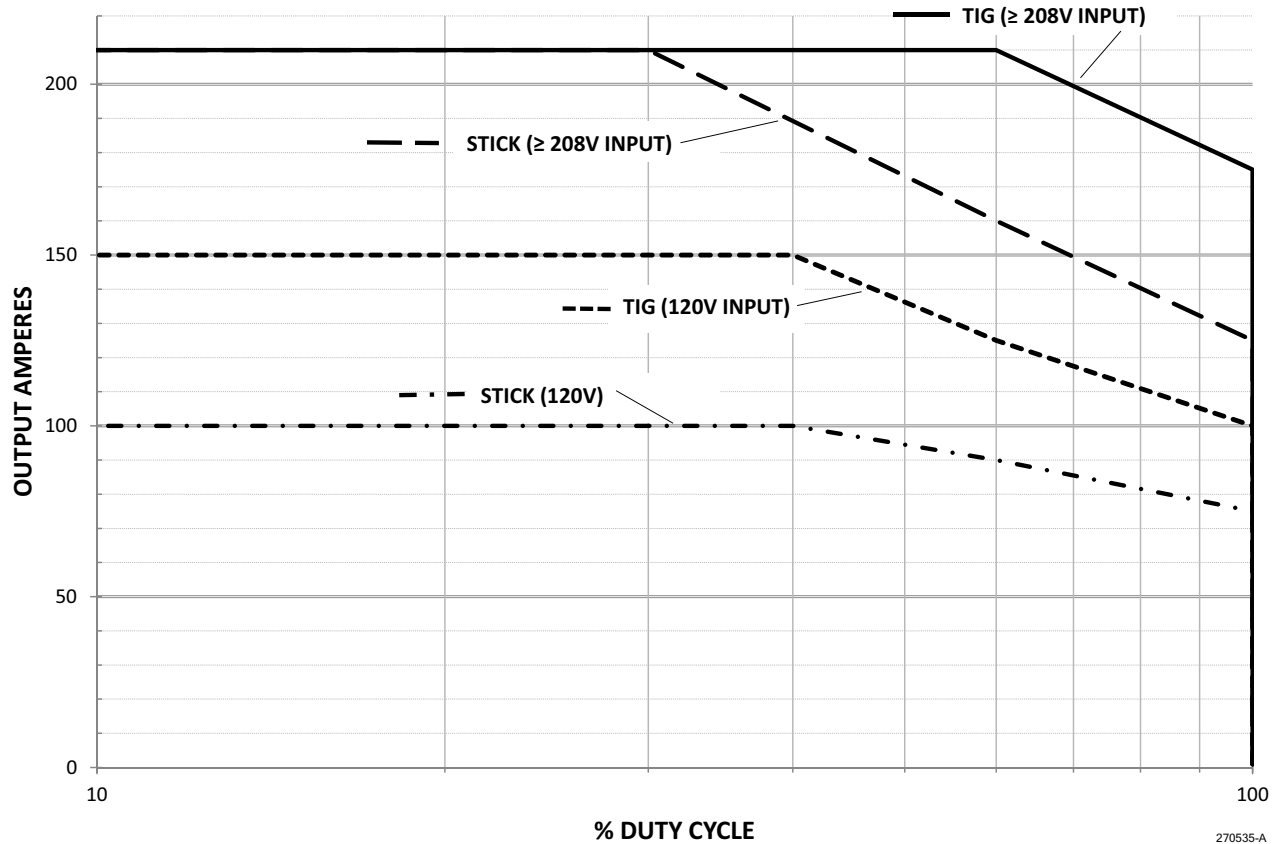

Figure 4-1. Overheating

SECTION 5 – INSTALLATION

5-1. Selecting A Location



Movement



Location And Airflow

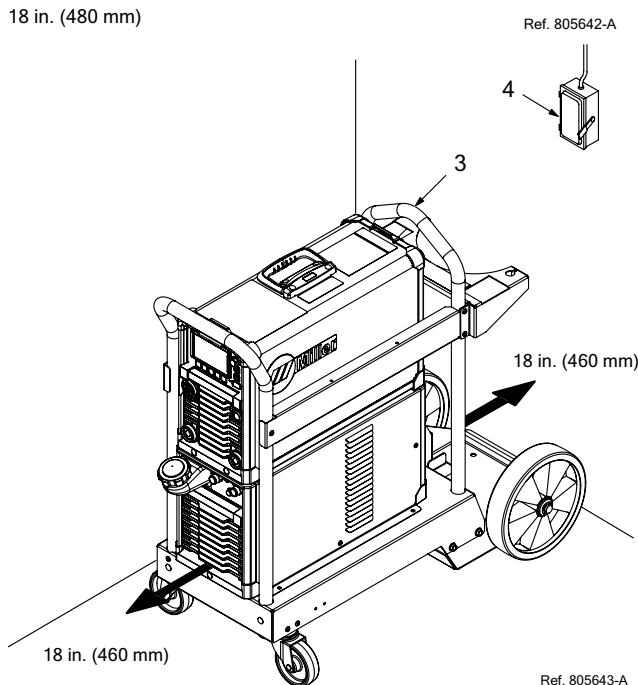
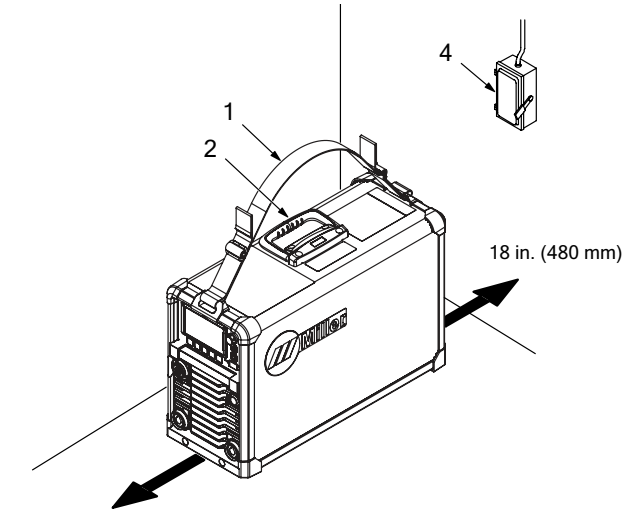

⚠ Do not move or operate unit where it could tip.

⚠ Special installation may be required where gasoline or volatile liquids are present - see NEC Article 511 or CEC Section 20.

1 Carry Strap

Use strap to carry power source only.

⚠ Do not use carry strap to lift welder when attached to cart/cooler.

2 Carry Handle

Use carry handle to carry power source only.

⚠ Do not use carry handle to lift welder when attached to cart/cooler.

3 Lift Point

Use lift point to move and lift welder/cart/cooler.

⚠ Do not use lift handle to lift unit when gas cylinder and accessories are connected.

4 Line Disconnect Device

Locate unit near correct input power supply.

☞ See Section 4-5 for lifting means ratings.

5-2. Selecting Cable Sizes¹

NOTICE – The Total Cable Length in Weld Circuit (see table below) is the combined length of both weld cables. For example, if the power source is 100 ft (30 m) from the workpiece, the total cable length in the weld circuit is 200 ft (2 cables x 100 ft). Use the 200 ft (60 m) column to determine cable size.

	Weld Cable Size ² and Total Cable (Copper) Length in Weld Circuit Not Exceeding			
	100 ft (30 m) or Less ⁴		150 ft (45 m)	200 ft (60 m)
Welding Amperes ³	10 - 60% Duty Cycle AWG (mm ²)	60 - 100% Duty Cycle AWG (mm ²)	10 - 100% Duty Cycle AWG (mm ²)	
100	4 (20)	4 (20)	4 (20)	3 (30)
150	3 (30)	3 (30)	2 (35)	1 (50)
200	3 (30)	2 (35)	1 (50)	1/0 (60)
250	2 (35)	1 (50)	1/0 (60)	2/0 (70)

¹ This chart is a general guideline and may not suit all applications. If cable overheats, use next size larger cable.

² Weld cable size (AWG) is based on either a 4 volts or less drop or a current density of at least 300 circular mils per ampere. () = mm² for metric use.

³ Select weld cable size for pulsing application at peak amperage value.

⁴ For distances longer than 100 ft (30 m) and up to 200 ft (60 m), use direct current (DC) output only. For distances longer than those shown in this guide, see AWS Fact Sheet No. 39, Welding Cables, available from the American Welding Society at <http://www.aws.org>.

5-3. Connections



Front Panel

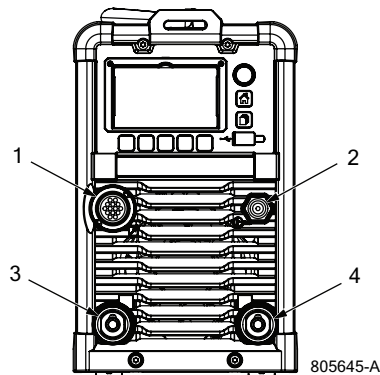

Rear Panel

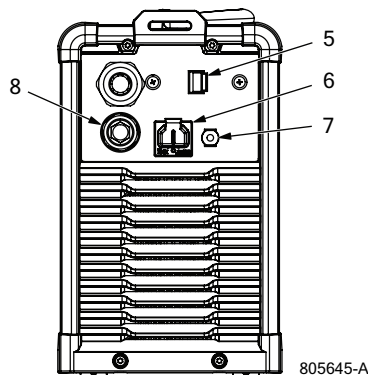

Turn off power before connecting to weld output terminals.

Do not use worn, damaged, undersized, or repaired cables.

1 Remote Control Receptacle (See Section 5-10)

2 Gas Out To Torch Connection

Requires an 11/16 in. wrench.

3 Work Lead Connection

4 TIG Torch Or Stick Electrode Holder Connection

5 Main Power Switch

Use switch to energize/de-energize machine.

6 Optional Coolmate 1.3 Dedicated Power Supply Receptacle

7 Supplementary Protector For Coolmate 1.3 Dedicated Power Supply

Included with optional dedicated Coolmate 1.3 power supply receptacle.

8 Gas In Connection

Fitting has 5/8-18 in. right hand threads, and usually requires an 11/16 in. wrench. Maximum psi is 125.

11/16 in. (21 mm for CE units)

5-4. Cooler Connections

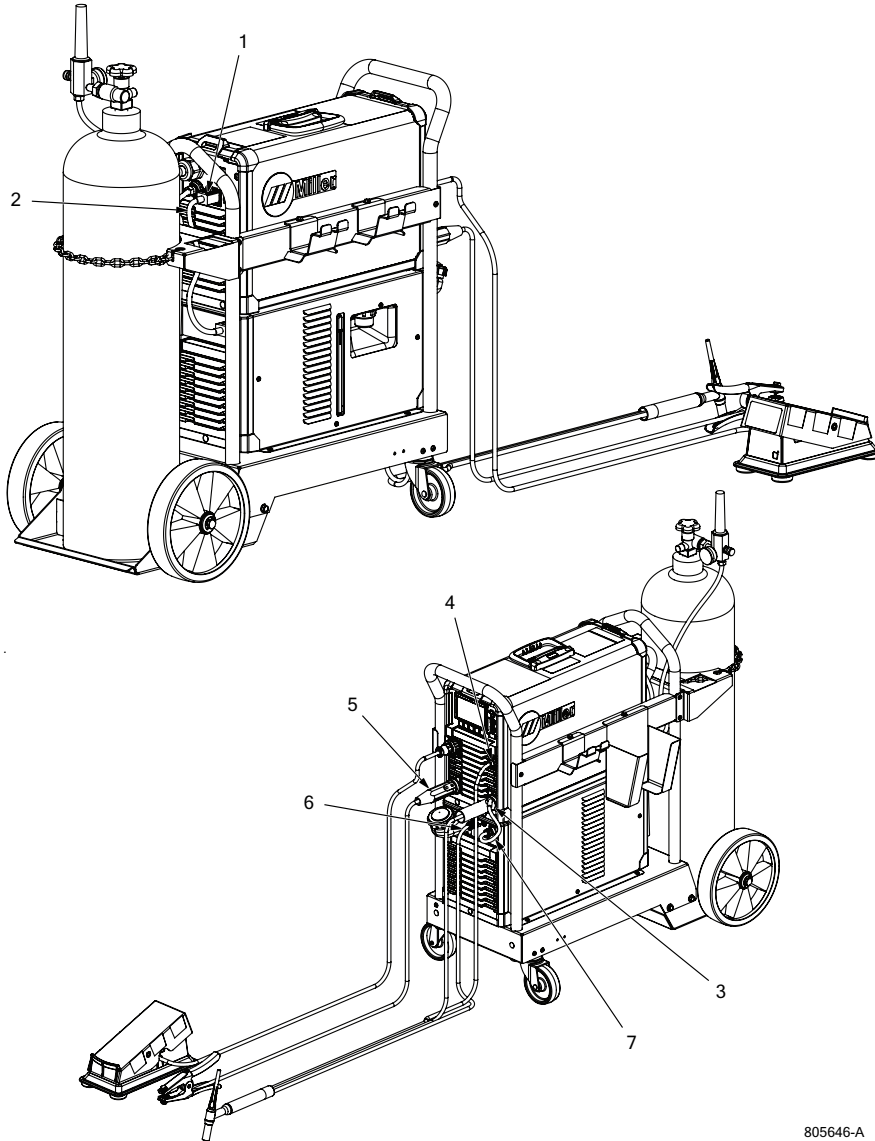

 11/16 in. (21 mm for CE units)

 Cart and cooler are optional equipment.

- 1 Coolmate 1.3 Power Receptacle
- 2 Cooler Power Cord

Provides 115 VAC to power cooler.

- 3 Electrode Weld Output Terminal

Connect TIG torch to electrode weld output terminal.

- 4 Gas Out Connection

Connect TIG torch gas hose to gas out fitting.

- 5 Work Weld Output Terminal

Connect work lead to work weld output terminal.

- 6 Water-Out (To Torch) Connection

Connect torch water-in (blue) hose to cooler's water-out connection.

- 7 Water-In (From Torch) Connection

Connect torch water-out (red) hose to cooler's water-in connection.

Coolant Specifications

Application	GTAW or where HF (high frequency current) is used
Coolant (1–1/4 gal)	Low Conductivity Coolant 043810 <ul style="list-style-type: none"> ● 50/50 solution ● Protects to –37°F (–38°C) ● Resists algae growth Distilled or dionized water okay above 32°F (0°C)

NOTICE – Use of any coolant other than those listed in the table voids the warranty on any parts that come in contact with the coolant (pump, radiator, etc.).

805646-A

5-5. Arranging Weld Cables To Reduce Welding Circuit Inductance



Bad

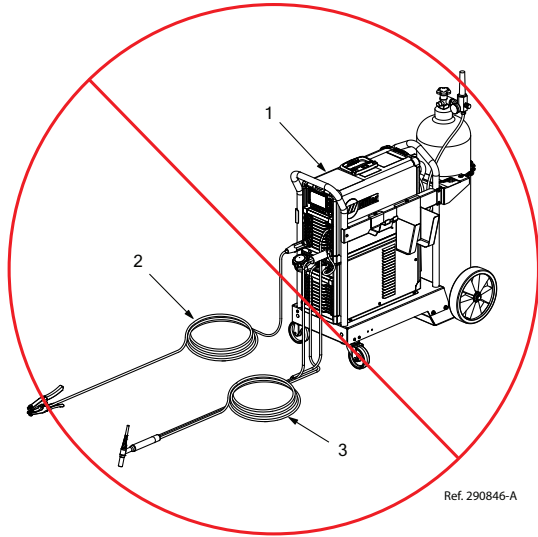

Ref. 290846-A

- 1 Welding Power Source
- 2 Work Cable
- 3 Electrode Cable

The arrangement of the cables has an effect that is significant to the welding properties. As an example, incorrect cable management can lead to higher welding circuit inductance which can result in limited current rise affecting welding performance.

Do not coil excess cables. Use cables that are the appropriate length for the application. Whenever using long weld cables [longer than 50 ft (15 m)] try to arrange positive and negative weld cables together to reduce the magnetic field surrounding the cables.

Better

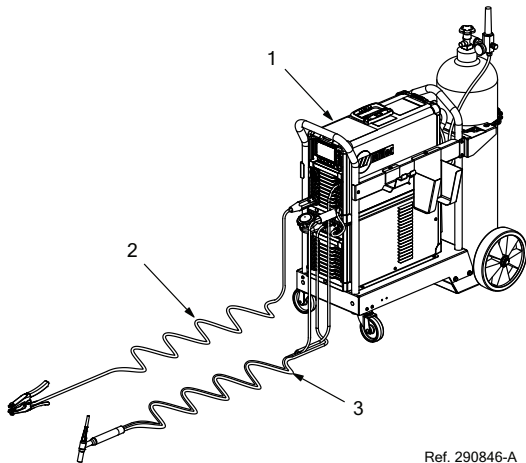

Ref. 290846-A

Best

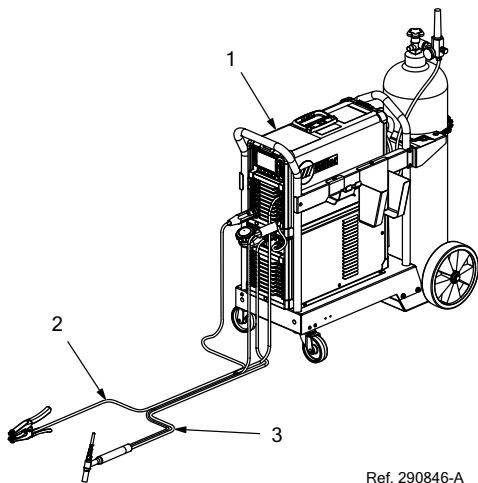

Ref. 290846-A

5-6. Electrical Service Guide (1-Phase)

⚠ Failure to follow these electrical service guide recommendations could create an electric shock or fire hazard. These recommendations are for an individual branch circuit sized for the rated output and duty cycle of one welding power source. In individual branch circuit installations, the National Electrical Code (NEC) allows the receptacle or conductor rating to be less than the rating of the circuit protection device. All components of the circuit must be physically compatible. See NEC articles 210.21, 630.11, and 630.12.

☞ Actual input voltage should not fall below 108 volts AC or rise above 528 volts AC. If actual input voltage is outside this range, unit may not operate according to specifications.

	1-Phase				
Rated Supply Voltage (V)	120	208	240	400	480
Rated Maximum Supply Current I_{1max} (A)	31.8	38.7	32.8	19.6	16.4
Rated Effective Supply Current I_{1eff} (A)	22.4	22.0	18.3	11.0	9.2
Time Delay Fuses ²	35	45	40	20	20
Normal Operating Fuses³	45	50	45	25	20
Maximum Recommended Supply Conductor Length In Feet (Meters)⁴	48 (15)	68 (21)	55 (17)	100 (31)	143 (44)
Raceway Installation					
Minimum Supply Conductor Size In AWG (mm²)⁵	10 (6)	10 (6)	12 (4)	14 (2.5)	14 (2.5)
Minimum Grounding Conductor Size In AWG (mm²)⁵	10 (6)	10 (6)	12 (4)	14 (2.5)	14 (2.5)
Flexible Cord Installation					
Minimum Supply Conductor Size In AWG (mm²)⁶	12 (4)	12 (4)	12 (4)	14 (2.5)	14 (2.5)

Reference: 2020 National Electrical Code (NEC) (including article 630)

2 "Time-Delay" fuses are UL class "RK5" . See UL 248.

3 "Normal Operating" (general purpose - no intentional delay) fuses are UL class "K5" (up to and including 60 amps), and UL class "H" (65 amps and above).

4 Maximum total length of copper input conductors in entire installation, raceway and/or flexible cord.

5 Raceway conductor data in this section specifies conductor size (excluding flexible cord or cable) between the panelboard and the equipment per NEC Table 310.15(B)(16) and is based on allowable ampacities of insulated copper conductors having a temperature rating of 75°C (167°F) with not more than three single current-carrying conductors in a raceway.

6 Flexible cord conductor size is based on NEC Table 400.5(A)(1) for SOOW 600V 90°C (194°F) jacketed cable in a 30°C (86°F) ambient temperature. See NEC Table 310.15(B)(2)(a) for ambient temperature correction factors. Flexible cord used for connection to the power supply system shall comply with the requirements of CSA C22.2 No. 49.

5-7. Electrical Service Guide (3-Phase)

⚠ Failure to follow these electrical service guide recommendations could create an electric shock or fire hazard. These recommendations are for an individual branch circuit sized for the rated output and duty cycle of one welding power source. In individual branch circuit installations, the National Electrical Code (NEC) allows the receptacle or conductor rating to be less than the rating of the circuit protection device. All components of the circuit must be physically compatible. See NEC articles 210.21, 630.11, and 630.12.

☞ Actual input voltage should not fall below 108 volts AC or rise above 528 volts AC. If actual input voltage is outside this range, unit may not operate according to specifications.

	3-Phase			
Rated Supply Voltage (V)	208	240	400	480
Rated Maximum Supply Current I_{1max} (A)	22.2	18.9	11.8	9.8
Rated Effective Supply Current I_{1eff} (A)	12.5	10.6	6.7	6.2
Time Delay Fuses ²	25	20	15	10
Normal Operating Fuses³	30	25	15	15
Maximum Recommended Supply Conductor Length In Feet (Meters)⁴	54 (16)	73 (22)	197 (60)	285 (87)
Raceway Installation				
Minimum Supply Conductor Size In AWG (mm²)⁵	14 (2.5)	14 (2.5)	14 (2.5)	14 (2.5)
Minimum Grounding Conductor Size In AWG (mm²)⁵	14 (2.5)	14 (2.5)	14 (2.5)	14 (2.5)
Flexible Cord Installation				
Minimum Supply Conductor Size In AWG (mm²)⁶	14 (2.5)	14 (2.5)	14 (2.5)	14 (2.5)

Reference: 2020 National Electrical Code (NEC) (including article 630)

2 "Time-Delay" fuses are UL class "RK5" . See UL 248.

3 "Normal Operating" (general purpose - no intentional delay) fuses are UL class "K5" (up to and including 60 amps), and UL class "H" (65 amps and above).

4 Maximum total length of copper input conductors in entire installation, raceway and/or flexible cord.

5 Raceway conductor data in this section specifies conductor size (excluding flexible cord or cable) between the panelboard and the equipment per NEC Table 310.15(B)(16) and is based on allowable ampacities of insulated copper conductors having a temperature rating of 75°C (167°F) with not more than three single current-carrying conductors in a raceway.

6 Flexible cord conductor size is based on NEC Table 400.5(A)(1) for SOOW 600V 90°C (194°F) jacketed cable in a 30°C (86°F) ambient temperature. See NEC Table 310.15(B)(2)(a) for ambient temperature correction factors. Flexible cord used for connection to the power supply system shall comply with the requirements of CSA C22.2 No. 49.

5-8. Connecting 1-Phase Input Power

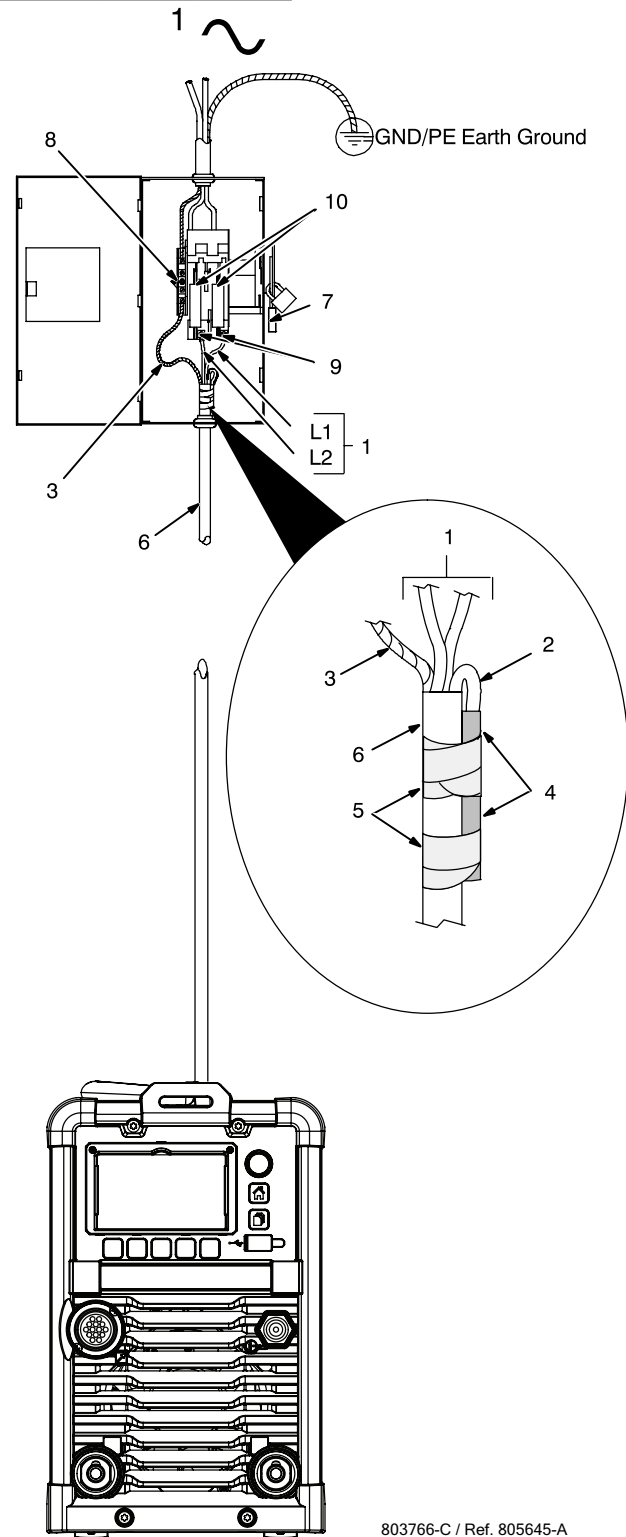

- ⚠ Installation must meet all National and Local Codes—have only qualified persons make this installation.
- ⚠ Disconnect and lockout/tagout input power before connecting input conductors from unit. Follow established procedures regarding the installation and removal of lockout/tagout devices.
- ⚠ Always connect green or green/yellow conductor to supply grounding terminal first, and never to a line terminal.

NOTICE – The Auto-Line circuitry in this unit automatically adapts the power source to the primary voltage being applied. Check input voltage available at site. This unit can be connected to any input power between 120-480 VAC without removing cover to relink the power source.

See rating label on unit and check input voltage available at site.

- 1 Black And White Input Conductor (L1 And L2) (or Black and Grey for CE)
 - 2 Red Input Conductor (or Brown for CE)
 - 3 Green Or Green/Yellow Grounding Conductor
 - 4 Insulation Sleeving
 - 5 Electrical Tape
- Insulate and isolate red conductor as shown.
- 6 Input Power Cord
 - 7 Disconnect Device (switch shown in the OFF position)
 - 8 Disconnect Device Grounding Terminal
 - 9 Disconnect Device Line Terminals

Connect green or green/yellow grounding conductor to disconnect device grounding terminal first.

Connect input conductors L1 and L2 to disconnect device line terminals.

10 Over-Current Protection

Select type and size of over-current protection using Electrical Service Guide (fused disconnect switch shown).

Close and secure door on disconnect device. Follow established lockout/tagout procedures to put unit in service.

803766-C / Ref. 805645-A



5-9. Connecting 3-Phase Input Power

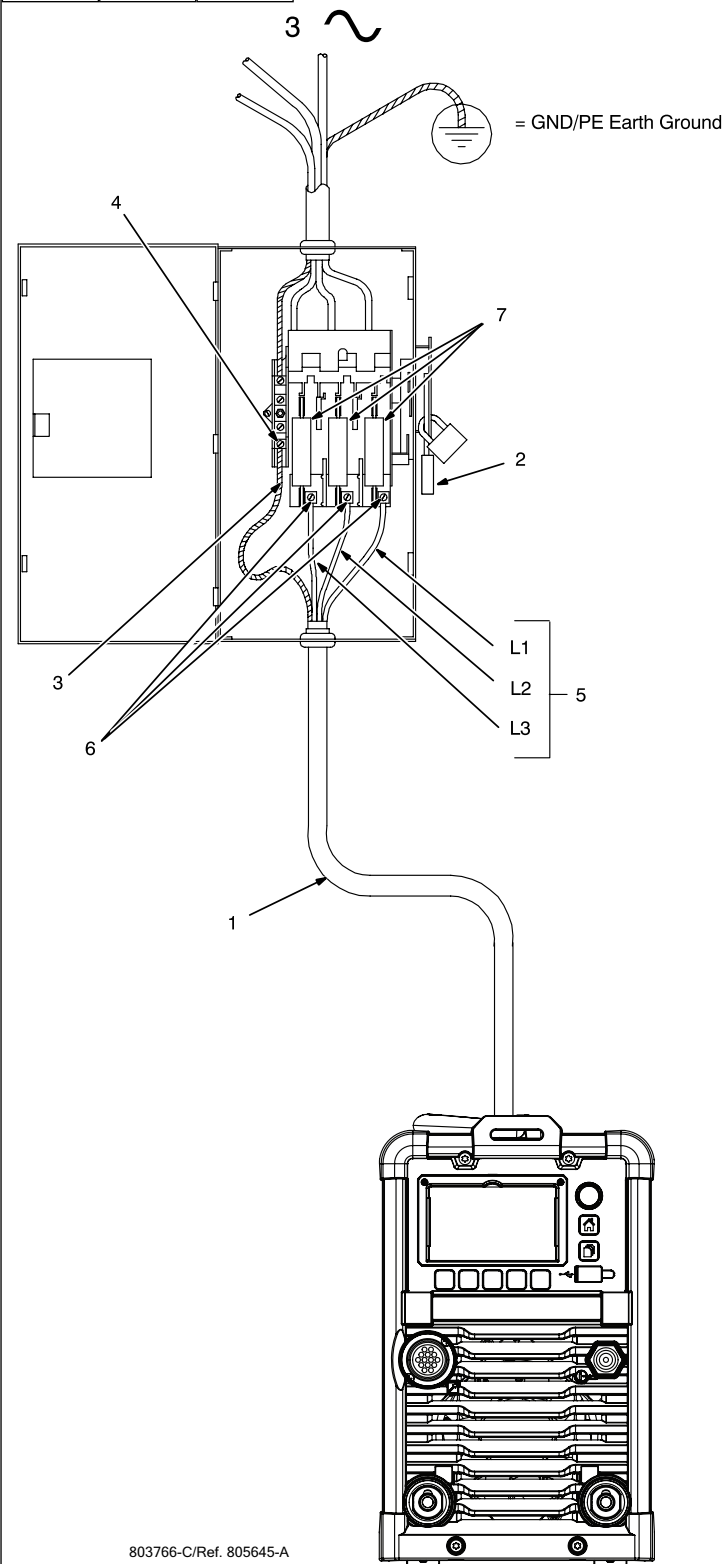

803766-C/Ref. 805645-A



- ⚠ Installation must meet all National and Local Codes—have only qualified persons make this installation.
- ⚠ Disconnect and lockout/tagout input power before connecting input conductors from unit. Follow established procedures regarding the installation and removal of lockout/tagout devices.
- ⚠ Always connect green or green/yellow conductor to supply grounding terminal first, and never to a line terminal.

NOTICE – The Auto-Line circuitry in this unit automatically adapts the power source to the primary voltage being applied. Check input voltage available at site. This unit can be connected to any input power between 120-480 VAC without removing cover to relink the power source.

See rating label on unit and check input voltage available at site.

For Three-Phase Operation

- 1 Input Power Cord
- 2 Disconnect Device (switch shown in the OFF position)
- 3 Green Or Green/Yellow Grounding Conductor
- 4 Disconnect Device Grounding Terminal
- 5 Input Conductors (L1, L2, And L3)
- 6 Disconnect Device Line Terminals

Connect green or green/yellow grounding conductor to disconnect device grounding terminal first.

Connect input conductors L1, L2, and L3 to disconnect device line terminals.

7 Over-Current Protection

Select type and size of over-current protection using Electrical Service Guide (fused disconnect switch shown).

Close and secure door on disconnect device. Follow established lockout/tagout procedures to put unit in service.

5-10. Remote 14 Receptacle Information

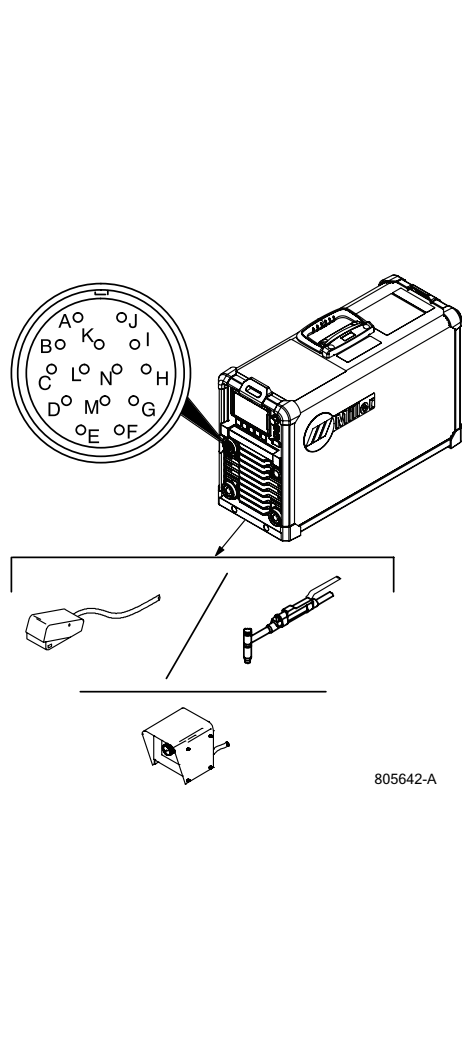
	Remote 14	Socket	Socket Information
	15 Volts DC Output Contactor		A
		B	Contact closure to A completes 15 volts DC contactor control circuit and enables output.
Remote Output Control		C	Output to remote control; +10 volts DC output to remote control.
		D	Remote control circuit common.
		E	0 to +10 volts DC input command signal from remote control. ¹ Reconfigurable as input for Output Enable (Weld Stop) - used to remotely stop the weld outside the normal welding cycle. Connection to the D socket must be maintained at all times. If the connection is broken, output stops, and Auto Stop is displayed.
Output Signals		F	Current feedback; +1 volt DC per 100 amps output.
		H	Voltage feedback; +1 volt DC per 10 volts output.
		I ¹	Valid arc indication closed to socket G with valid arc. Electrical specifications: open collector transistor (see Section 5-11 for connection example).
		J ¹	Arc length control lockout closed to socket G during Initial and Final Amperage and Slope, and during the background time of a ≤ 10 Hz pulse waveform. Electrical specifications: open collector transistor (see Section 5-11 for connection example).
	2	Touch Sense Detection closed to Socket G, with Modbus's Touch Sense enabled and machine not triggered for weld output.	
Common		G	Return for all output signals: F, H, I, J and A.
Chassis		K	Chassis
Serial Communication Bus		L ²	Modbus Common (RS485 Common)
		M ²	Modbus D1 (RS485 B+)
		N ²	Modbus D0 (RS485 A-)

Sockets G and K are electrically isolated from each other.

¹ Available with optional Automation Expansion memory card.

² Available with optional Modbus Expansion memory card. Modbus serial communication provides access to all front panel parameters and machine functionality. See Owner's Manual 265415 for a list of Modbus registers. Modbus expansion also includes functionality of Automation, Hot Wire, and Hot Start Adjust expansions.

 If a remote hand control like the RHC-14 is connected to the Remote 14 receptacle, some current value above min. must be set on the remote control before the Panel or Remote contactor is turned on. Failure to do so will cause current to be controlled by the panel control, and the remote hand control will not function.

5-11. Simple Automation Application

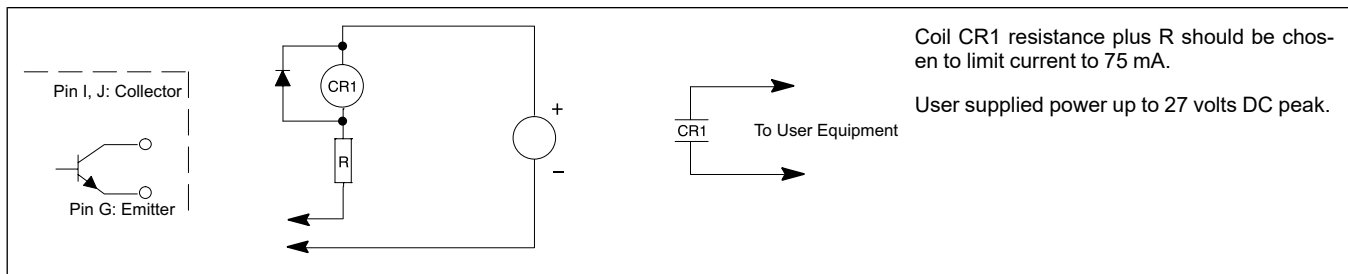

5-12. Software Updates

A. Downloading Software Updates

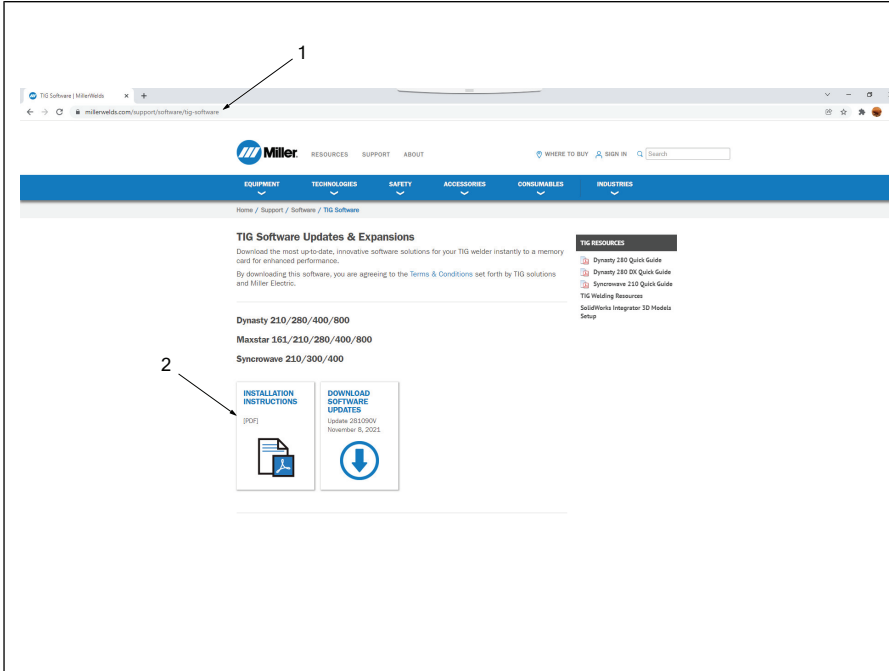

Reasons To Download Software Updates:

- To get the latest feature and software improvements with future software updates.
- For all circuit board replacements, a software update is required to ensure proper unit operation.
- A software update is required to ensure proper software expansion operation of all purchased feature expansions.

Requirements

A computer with a USB port and a blank USB stick formatted as fat32 is required to download software updates.

How To Download Software Updates

1 In a web browser, go to <https://www.miller-welds.com/support/software/tig-software>

2 Click **Installation Instructions (PDF)** and follow the instructions.

B. Installing Software Updates

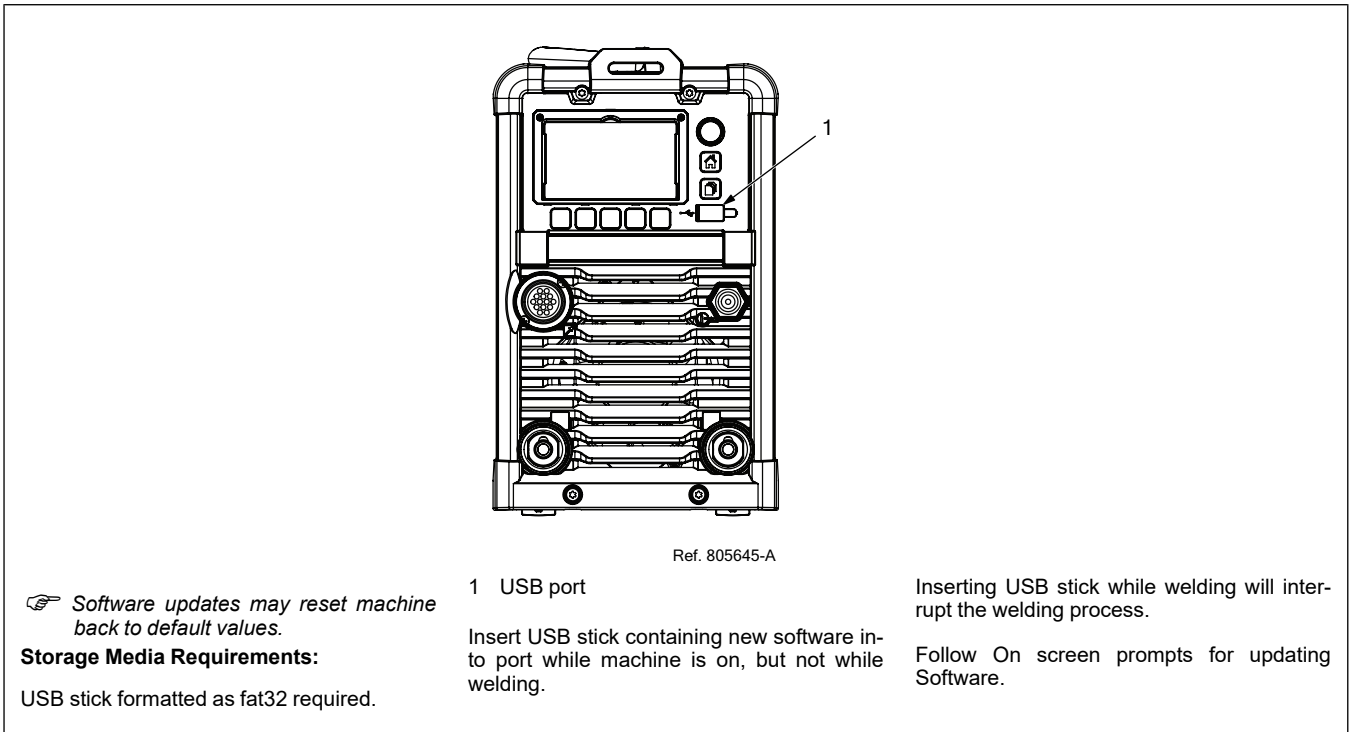

Ref. 805645-A

☞ *Software updates may reset machine back to default values.*

Storage Media Requirements:

USB stick formatted as fat32 required.

1 USB port

Insert USB stick containing new software into port while machine is on, but not while welding.

Inserting USB stick while welding will interrupt the welding process.

Follow On screen prompts for updating Software.

SECTION 6 – OPERATION

6-1. Home Screen - Primary

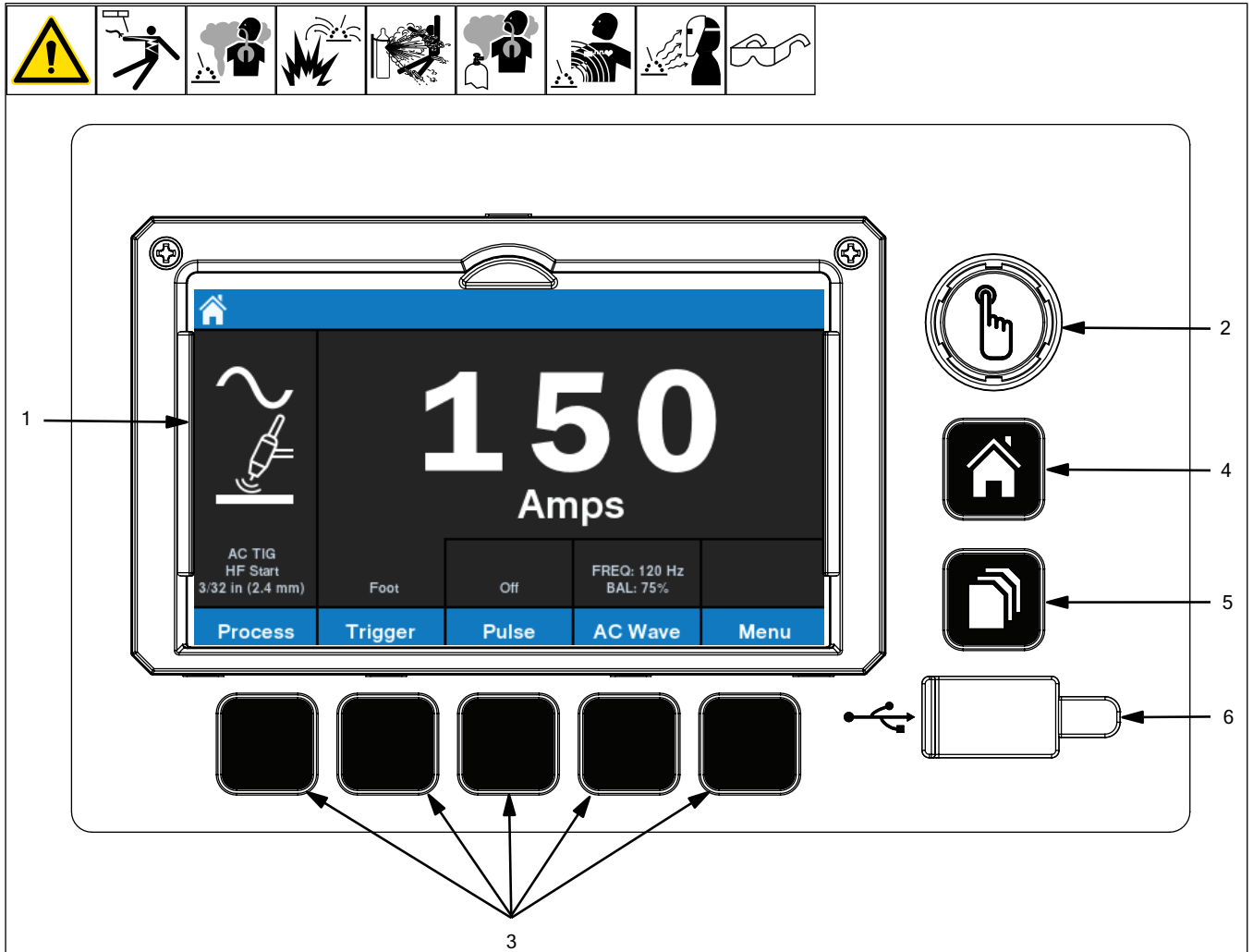

1 Color LCD Display

Program name and output status will display in top information header. Preview select parameter settings.

2 Control Knob

Rotate to adjust selected parameter (Amperage on home screen) and/or navigate through various menus. Depress to select and open variable adjustment screens.

Depress to select and lock in parameters when in variable adjustment screens.

3 Soft Keys

Multiple functions depending on which screen is being displayed.

4 Home Button

Returns user to the home screen.

5 Memory/Program Button

Opens the memory/program menu where users can Recall, Save and Delete weld settings in the 99 unique slots.

6 USB Port

Use for software upgrade, transferring data and collecting error codes.

6-2. Process Selection

1 Control Knob

2 Process Icon

Rotate to highlight the desired welding process. Depress to select.

Displays the IEC symbol for the highlighted process.

6-3. Trigger Selection



1 Control Knob

2 Trigger Icon

3 Trigger Description

Rotate to highlight the desired trigger method. Depress to select.

Preview of the selected trigger or trigger sequence.

Describes how the selected trigger or sequence would be used.

6-4. Pulsar Selections

The diagram illustrates the Pulsar Selections screen on a control panel. At the top, there is a row of safety icons including a warning sign, a person with a speech bubble, a person with a lightning bolt, a person with a flame, a person with a spark, a person with a flame, a person with a flame, a person with a flame, and a person with a flame. The main screen is titled 'Pulsar Selections' and features a gear icon in the top left corner. The screen is divided into several sections: 'Pulsar On/Off' (Pulsar On), 'Pulses Per Second' (100 PPS), 'Advanced Features' (containing '% Peak On Time' (40%), '% Background Amperage' (25%), and 'Pulse Waveshape' (Square)), and a bottom row of buttons labeled 'Process', 'Trigger', 'Pulse', and 'Tungsten'. A control knob is located on the right side of the screen, and a USB drive is shown below it. The diagram is annotated with numbers 1, 2, 3, and 4, pointing to the control knob, parameter value, common parameters, and advanced parameters respectively.

1 Control Knob
Rotate to highlight the desired parameter. Depress to select and enter parameter adjustment screen.







2 Parameter Value
Shows the current selected value.

3 Common Parameters
The least technical or most basic parameters; most common parameters to be adjusted if using this feature.

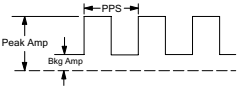
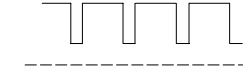
4 Advanced Parameters
The most technical or most complex parameters; not as commonly adjusted if using this feature.

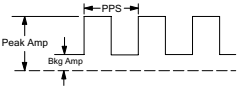
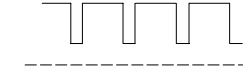
☞ Pulse Waveshape is only available in DC TIG modes.

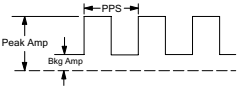
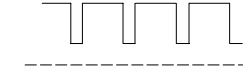
A. Pulse Descriptions

Pulses Per Second	% Peak On Time	% Background Amperage								
<p>Pulses Per Second- Pulse frequency or pulses per second, is the number of pulse cycles per second. Pulse frequency helps reduce heat input, part warpage, and helps weld bead cosmetics. The higher the PPS setting, the smoother the ripple effect, the narrower the weld bead, and the more cooling you get. By setting PPS on the lower end, the pulse is slower, and the weld bead wider. This slow pulsing helps agitate the weld puddle to help release gas trapped in the weldment, and help reduce porosity (very useful in aluminum welding). Some beginners use a slower pulse rate (2-4 pps) to help them with their timing on adding filler material. An experienced welder may have the PPS setting much higher, depending on their personal preferences, and on what they are trying to accomplish.</p>	<p>% Peak On Time - is the percentage of time in each cycle, spent at peak amperage (main amperage). Peak amperage is set with the Amperage control (see Operation section). If one pulse per second is being used, and peak time is set at 50%, one-half second is spent at peak amperage, and the other 50%, or one-half second, is spent at the background amperage. Increasing peak time increases time spent at peak amperage, which increases heat input into the part. A good starting point for peak time is about 50-60%. To find a good ratio, you will have to experiment a bit, but the idea is to decrease heat input into the part, and increase the cosmetics of the weld.</p> <p>Table shows effect changing the Peak Time control has on the pulsed output waveform.</p> <table border="1" data-bbox="626 680 1040 1146"> <thead> <tr> <th data-bbox="626 680 764 785">Percent (%) Peak Time Control Setting</th> <th data-bbox="764 680 1040 785">Pulsed Output Waveforms</th> </tr> </thead> <tbody> <tr> <td data-bbox="626 785 764 915">Peak 50%/ Background 50% Balanced 50%</td> <td data-bbox="764 785 1040 915">  </td> </tr> <tr> <td data-bbox="626 915 764 1020">80% More Time At Peak Amperage</td> <td data-bbox="764 915 1040 1020">  </td> </tr> <tr> <td data-bbox="626 1020 764 1146">20% More Time At Background Amperage</td> <td data-bbox="764 1020 1040 1146">  </td> </tr> </tbody> </table>	Percent (%) Peak Time Control Setting	Pulsed Output Waveforms	Peak 50%/ Background 50% Balanced 50%		80% More Time At Peak Amperage		20% More Time At Background Amperage		<p>% Background Amperage is set as a percentage of the peak amps setting. If peak amps is set at 200, and background amps at 50%, your background amps is 100 amps when the machine pulses on the background side of the cycle. The lower background amperage helps reduce heat input. Increasing or decreasing background amps increases or decreases the overall average amperage, which helps determine how fluid your puddle is on the background side of the pulse cycle. Overall, you want your puddle to shrink to about one-half the size, but still remain fluid. To start with, set background amps at about 20-30% for stainless/carbon steel, or at about 35-50% for aluminum alloys.</p> <p>Application:</p> <p>Pulsing refers to the alternating raising and lowering of the weld output at a specific rate. The raised portions of the weld output are controlled in width, height, and frequency, forming pulses of weld output. These pulses and the lower amperage level between them (called the background amperage) alternately heat and cool the molten weld puddle. The combined effect gives the operator better control of penetration, bead width, crowning, undercutting, and heat input. Controls can be adjusted while welding.</p> <p>Pulsing can also be used for filler material addition technique training.</p>
Percent (%) Peak Time Control Setting	Pulsed Output Waveforms									
Peak 50%/ Background 50% Balanced 50%										
80% More Time At Peak Amperage										
20% More Time At Background Amperage										

6-5. AC Waveform Selection

1 Control Knob

2 Parameter Value

3 Common Parameters

4 Advanced Parameters

AC Frequency Control - Controls the width of the arc cone. Increasing the AC Frequency provides a more focused arc and increased directional control. Note: Decreasing the AC Frequency softens the arc and broadens the weld puddle for a wider weld.

AC Balance Control - Controls arc cleaning action. Adjusting the % EN of the AC wave controls the width of the etching zone surrounding the weld.

☞ Set the AC Balance control for adequate arc cleaning (etching) action at the sides and in front of the weld puddle. AC Balance should be fine-tuned according to the amount of etching desired.

AC Waveform

- Advanced Squarewave: Travel faster
- Soft Squarewave: Max puddle control
- Sine Wave: Traditional arc
- Triangle Wave: Reduced heat input

Advanced AC Amperage Control Allows the EN and EP amperage values to be set independently. Adjusts the ratio of EN to EP amperage to precisely control heat input to the work and the electrode. EN amperage controls the amount of heat directed to the work, while EP amperage dramatically affects the arc cleaning action (along with the AC Balance control). Increased EN amperage also provides deeper penetration and allows for increased travel speeds.

6-6. Tungsten Selection

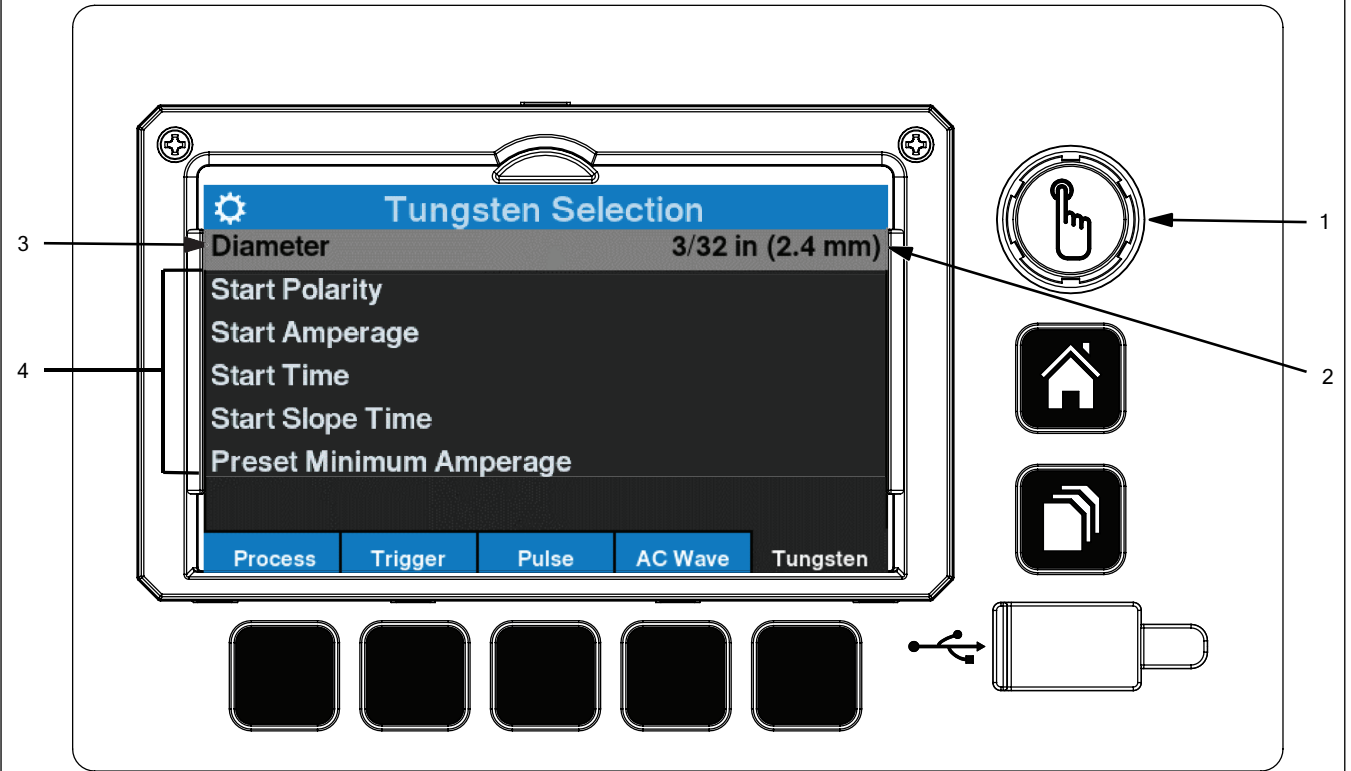
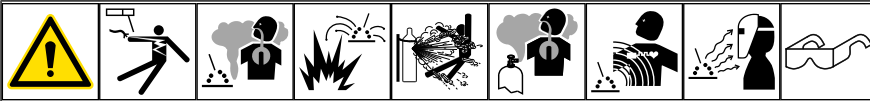

1 Control Knob

Rotate to highlight the desired parameter. Depress to select and enter parameter adjustment screen.

2 Parameter Value

Shows the current selected value.

3 Primary Tungsten Selection

Select from various preconfigured starting parameters to optimize arc starting based on the tungsten diameter being used.

4 Advanced Parameters

If General is selected for Diameter, the individual starting elements become accessible.

A. Parameter Settings

Parameter	Default AC	Default DC	Range
Start Output Polarity	EP (Electrode Positive)	EN (Electrode Negative)	EP/EN
Start Amperage	30 A	25 A	5-200 A
Start Time	120 ms	120 ms	0-250 ms
Start Slope Time	120 ms	120 ms	0-250 ms
Preset Minimum Amperage	10 A	10 A	1-25 A (DC) 2-25 A (AC)

6-7. Parameter Adjustment (AC Frequency)

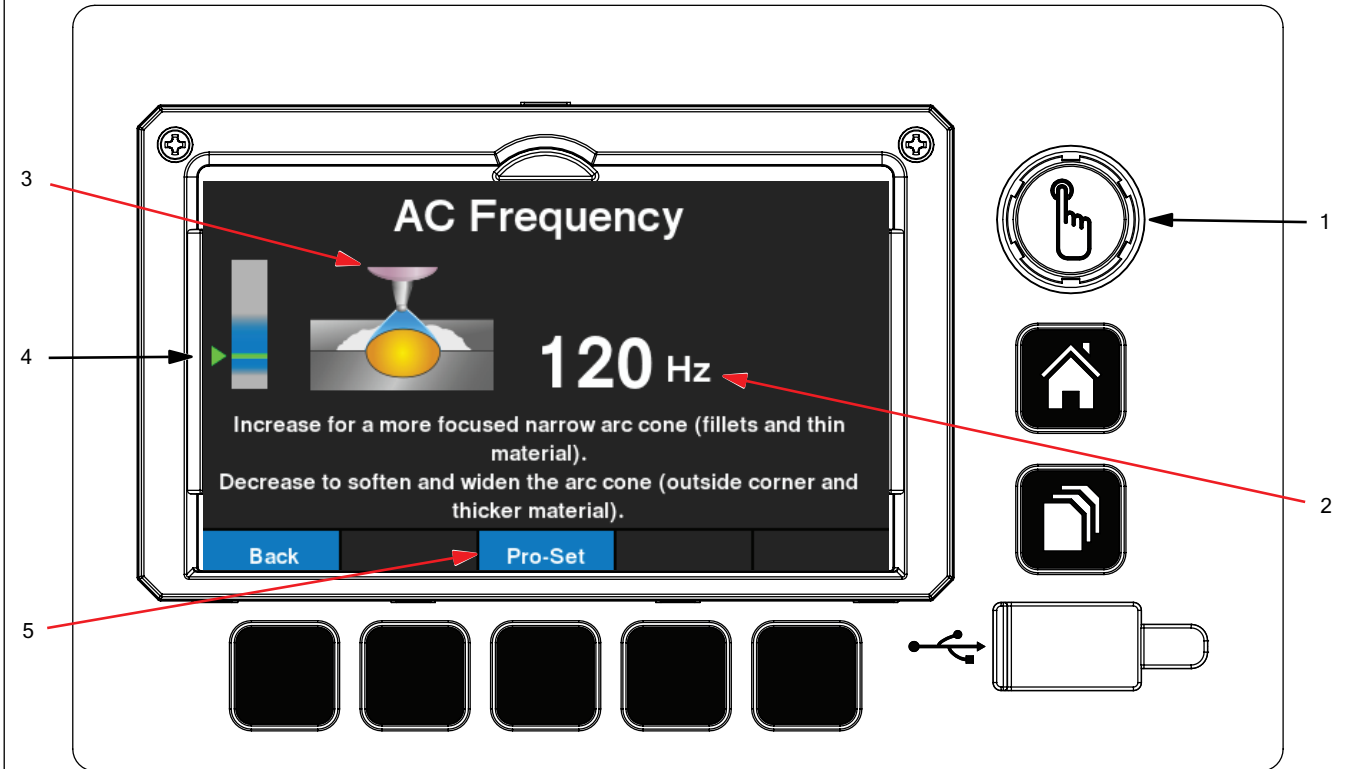
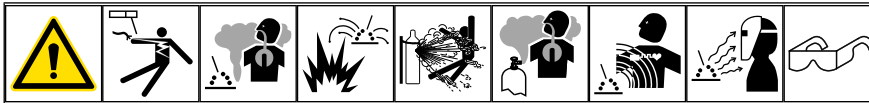

1 Control Knob

Rotate to highlight the desired parameter. Depress to select and exit parameter adjustment screen.

2 Parameter Value

Shows the current selected value.

3 Dynamic Visualization

Provides a generalized representation of what the user might expect to happen under normal operating conditions.

Accuracy of representation will vary based on other parameter selections.

4 Range And Pro-Set™ Indicator

As parameter is adjusted, the indicator moves within the range. Green arrow and line indicate factory defaults and Pro-Set selection. Blue shaded area shows the most commonly used range and gray area shows full parameter range.

5 Pro-Set (Soft Key)

Restores parameter to the Pro-Set value.

6-8. Home Screen - Sequencer - 2T Slope And Timers

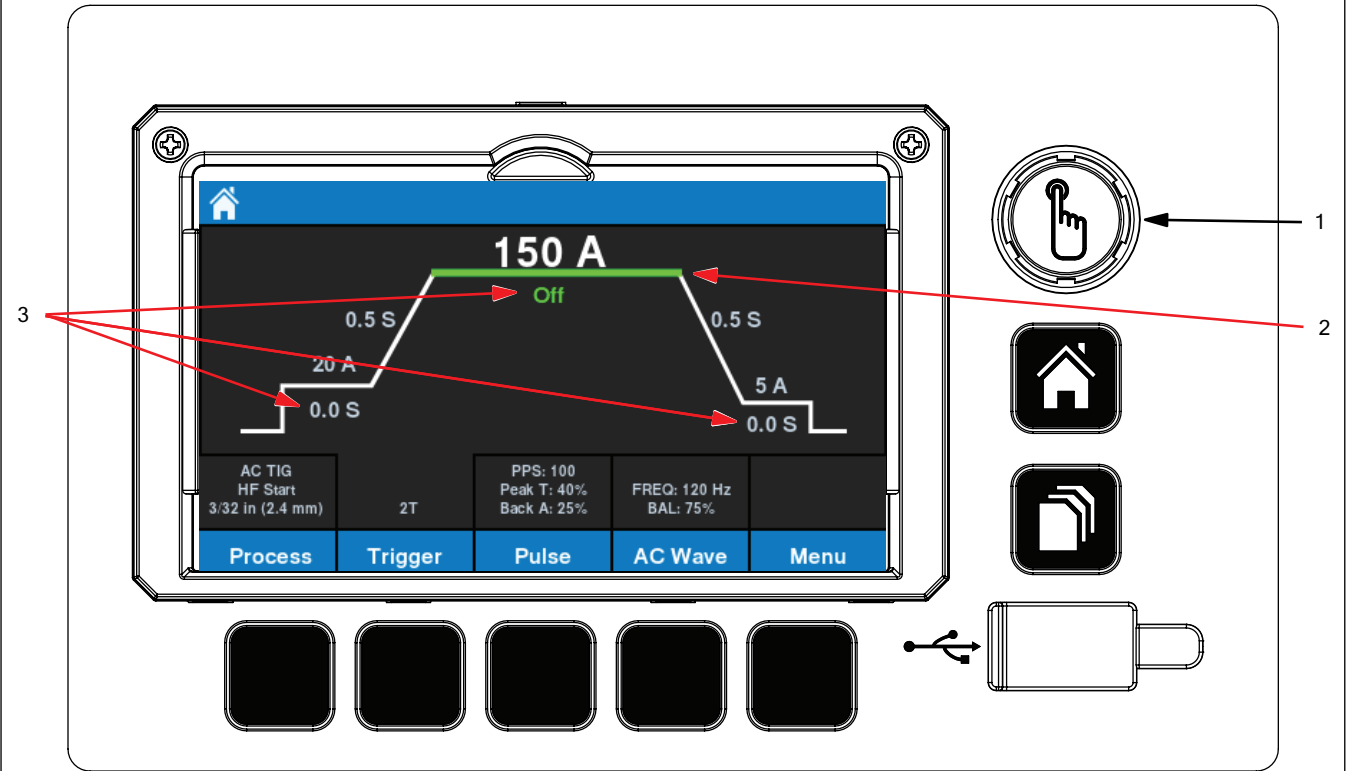
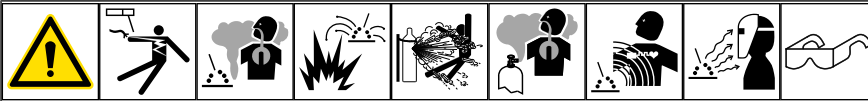

1 Control Knob

2 Parameter Selection Indicator (Green)

3 Weld Timers

Rotate to highlight the desired parameter value. Depress to select and exit parameter adjustment screen.

Highlights the parameter to be selected and adjusted. Depress to open parameter adjustment screen.

Allows for the weld sequence Initial, Weld and Final segments to be programmed by time rather than require an external input.

This is available in select trigger modes.

A. Sequencer And Range

Parameter	Range
Initial Amperage	2-210 amps AC, 1-210 amps DC.
¹ Initial Timer	OFF to 25.0T (seconds).
Initial Slope Time	OFF to 50.0T (seconds).
Final Slope Time	[OFF to 50.0T (seconds).
Final Amperage	2-210 amps AC, 1-210 amps DC.
¹ Final Time	Range is OFF to 25.0T (seconds).
Weld Timer	With Weld Timer enabled, press control knob, and rotate amperage adjustment control to set weld time. Range is Off or 0.1-99.9 and 100-999 (sec).
¹ Enabled features with weld timer On.	

6-9. Tech Menu

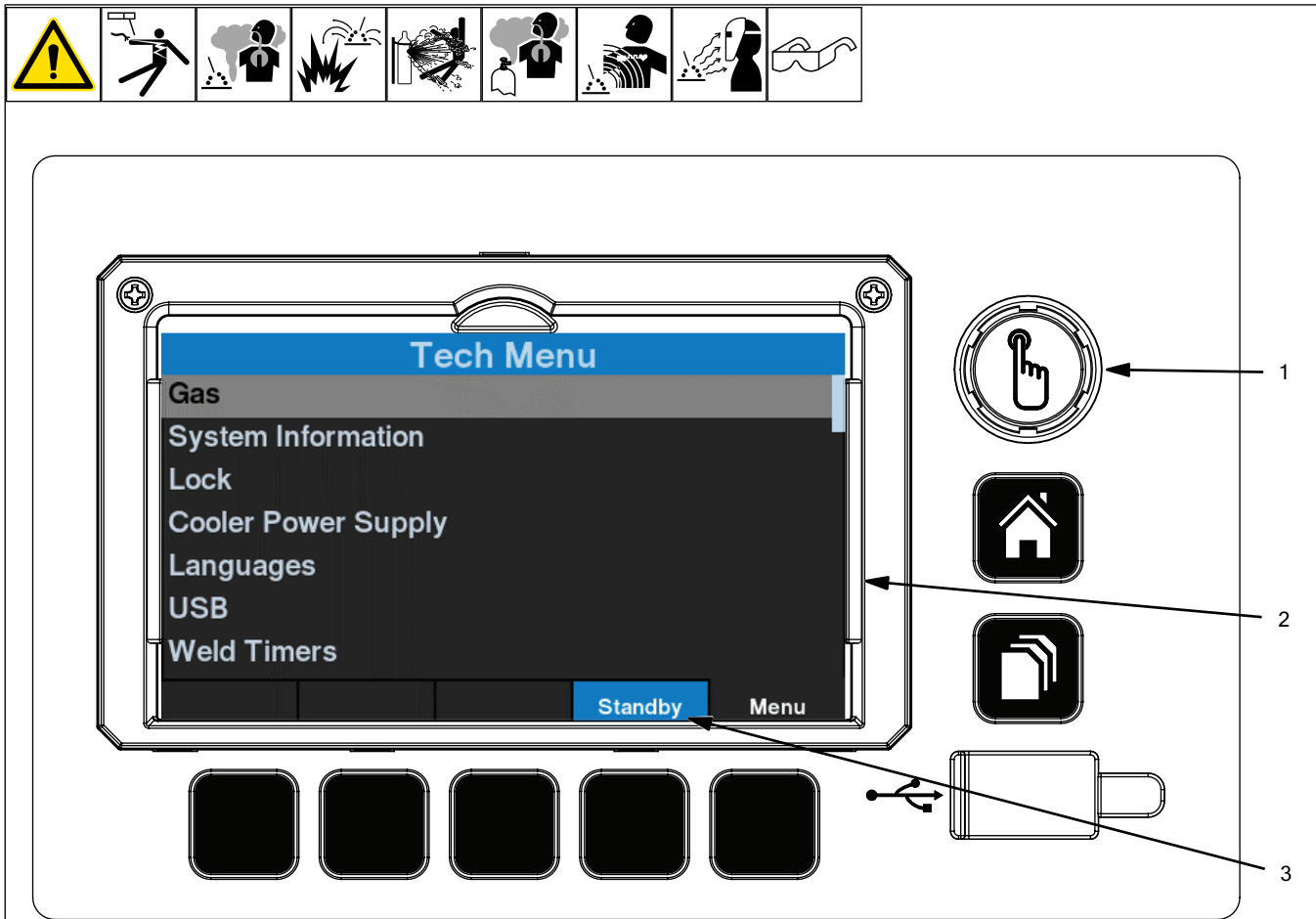

1 Control Knob

Rotate to highlight the desired selection. Depress to select.

2 Item or Sub Menu List:

Gas - Various gas related settings/functions such as preflow, post flow and torch purge functions.

System Information - Factory reset, System Logs (updates performed), error logs, software numbers, serial numbers, arc timer/counter, and user input Unit Identification.

Lock - Allows settings to be limited to a user defined range, locked to an individual value, or completely locked out. This function can be set a la carte and each program can have independent values.

Cooler Power Supply - Set the cooler power supply to Auto, On (continuous), Off. Enable/Disable the optional error trigger if output to the cooler is not detected during a valid arc state.

Languages - All display text will change based on selection.

USB - Used to update software, and to export and import programs and unit configuration.

Weld Timers - Allows for the weld sequence Initial, Weld and Final segments to be programmed by time rather than require an external input.

☞ See Home Screen - Sequencer

External Pulse Control - Turn on when it is desired to control machine from an external source (command voltage of 0 - 10 volts DC equals off - max of machine amps.)

Sleep Timer - Turns power off after the machine exceeds the programmed idle time without operation. Off - 60 minutes.

3 Standby Function (Soft Key)

Press to put unit into low power consumption mode.

6-10. Locks And Limits Screen

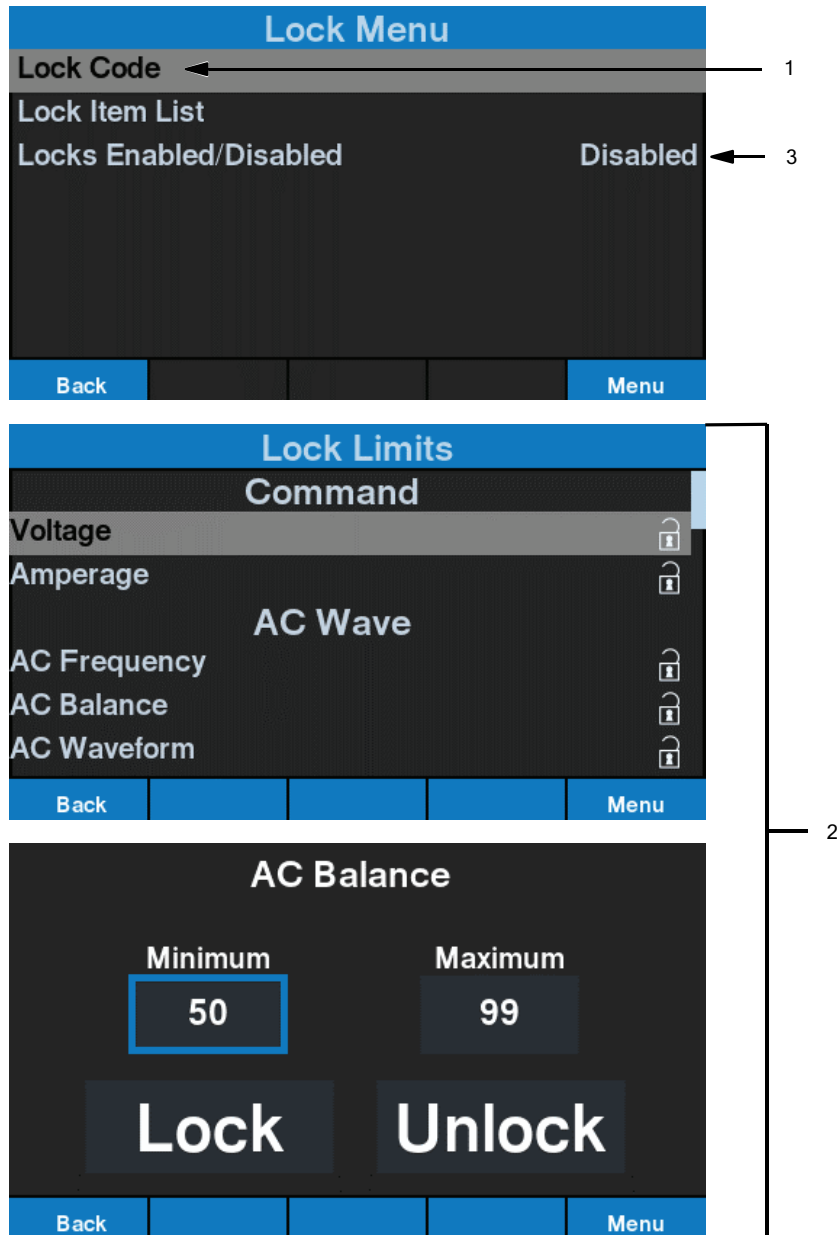
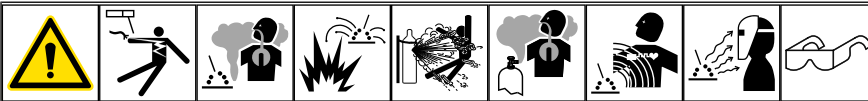

Locks And Limits

Locks and limits can be built and restricted by independent program/memory.

— Enable locks using steps 1-3 below.

— Save the program.

See Programs/Memory

— Disable locks using steps 1 and 3.

— Building another program and repeat steps.

1 Lock Code

Use control knob to select to input a lock code. Lock function cannot be enabled without inputting a code or disabled without re-entering the correct code.

Follow on screen prompts if lock code is lost or forgotten.

2 Lock Item List

Parameters and functions can be selected independently to remain unlocked (unrestricted), limited to a range (user defined minimum and maximum value)¹, or locked to a singular value (set minimum and maximum to the same values and lock).

¹Ranges available on select parameters (balance, frequency, amperage, pulse frequency, etc).

3 Lock Enable/Disable

Enable lock function prior to exiting the lock screen to activate all the locks and limits selected in the Lock Item List or Disable to create additional programs or to use the unit without restrictions.

This value must be set to Enable prior to exiting via the Back or Home buttons if Locks are desired.

6-11. Programs/Memories

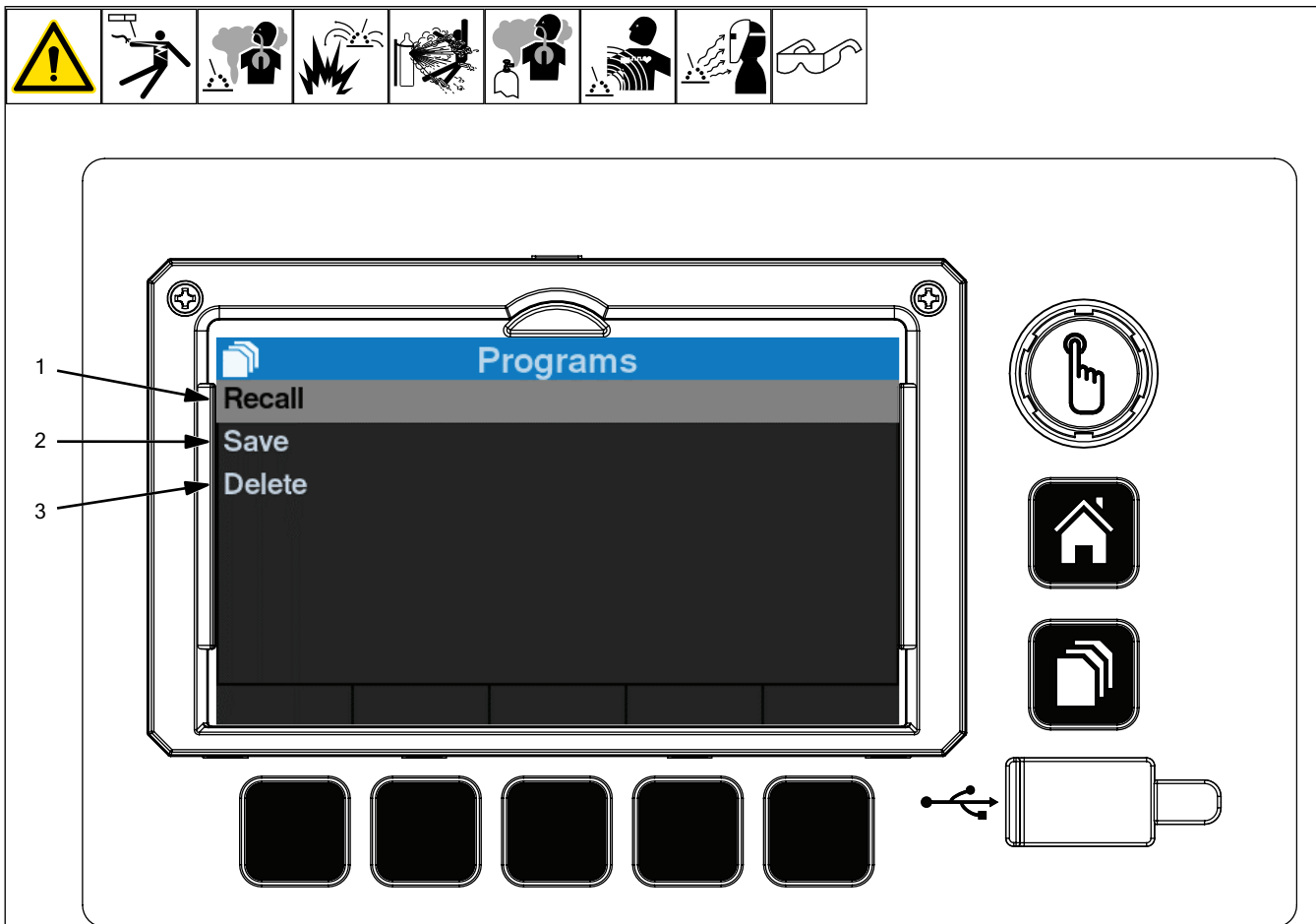

1 Recall

Load saved programs and all associated weld settings. Programs are listed by location number and user input name.

☞ If Locks and Limits are enabled the applicable values will accompany the programs.

2 Save

Users can name and store up to 99 programs, storing all associated weld settings, locks and limits.

☞ See Locks and Limits for instructions on how to build program specific ranges/locks.

3 Delete

Permanently erase individual programs that have been previously saved into the product.

6-12. USB Menu

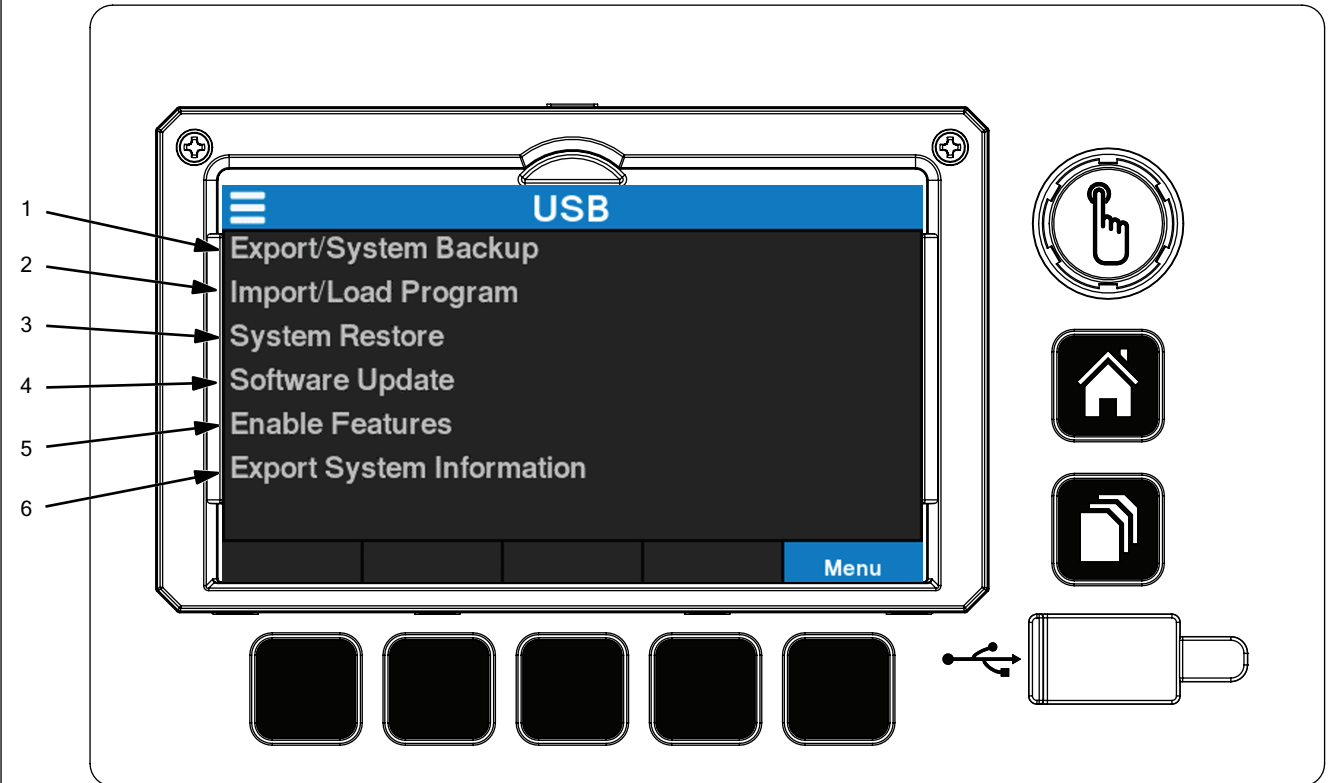
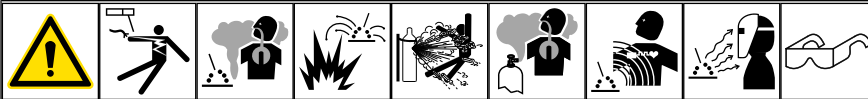

1 Export Files/System Backup

Creates a copy of the entire unit settings, parameters, and programs/memories. This can be used to transfer individual programs, multiple programs, clone units, or restore systems to a known state in the future.

2 Import/Load Program

Allows the user to import an individual program or an entire backup file.

3 System Restore

Utilize a backup file to restore entire unit settings, parameters, configurations, and programs/memories or to duplicate/clone various units.

4 Software Update

Executes the update to the latest software/firmware.

 Download the latest software update from Millerwelds.com/tigsoftware

5 Enable Features

Used to turn on feature expansions downloaded from manufacturer website.

 Any available software expansions can be downloaded from Millerwelds.com/tigsoftware

6 Export System Information

Creates a text file for easy service reference. This file contains information such as model number, serial number, software revision, individual board information and error log(s).

SECTION 7 – MAINTENANCE AND TROUBLESHOOTING

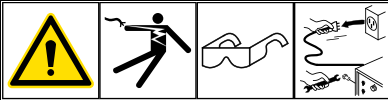

7-1. Routine Maintenance





Disconnect power before maintaining.

Maintain more often during severe conditions.

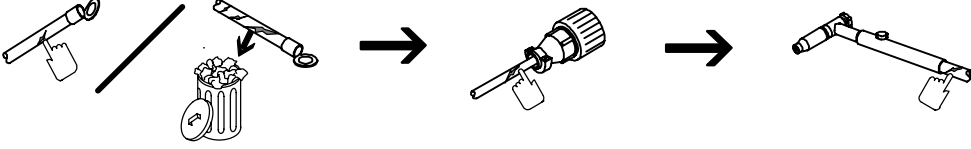
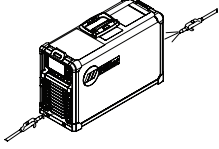
A. Welding Power Source

	✓ = Check	◇ = Change	○ = Clean	☆ = Replace
Every 3 Months	  ✓ ☆ Labels	 ✓ ☆ Gas Hoses		
	 ✓ ☆ Cables And Cords			
Every 6 Months	 ○ During heavy service, clean monthly. Do not remove case when blowing out inside of unit			

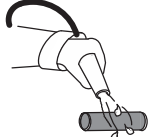
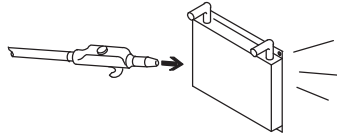
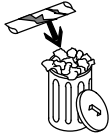
B. Optional Cooler

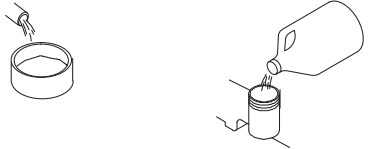
	✓ = Check	◇ = Change	○ = Clean	☆ = Replace
Every 3 Months		 ○ Coolant strainer; during heavy service, clean more frequently.	 ○ Blow out heat exchanger fins. ✓ Check coolant level. Top off with distilled or deionized water if necessary.	
Every 6 Months	 ✓ ☆ Hoses		  ✓ ☆ Labels	
Every 12 Months	 ◇ Coolant			

7-2. Blowing Out Inside Of Unit

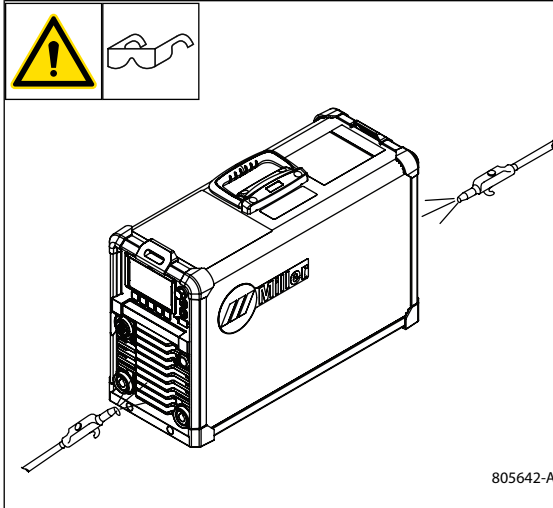

⚠ Do not remove case when blowing out inside of unit.

To blow out unit, direct airflow through front and back louvers as shown.

7-3. Coolant Maintenance

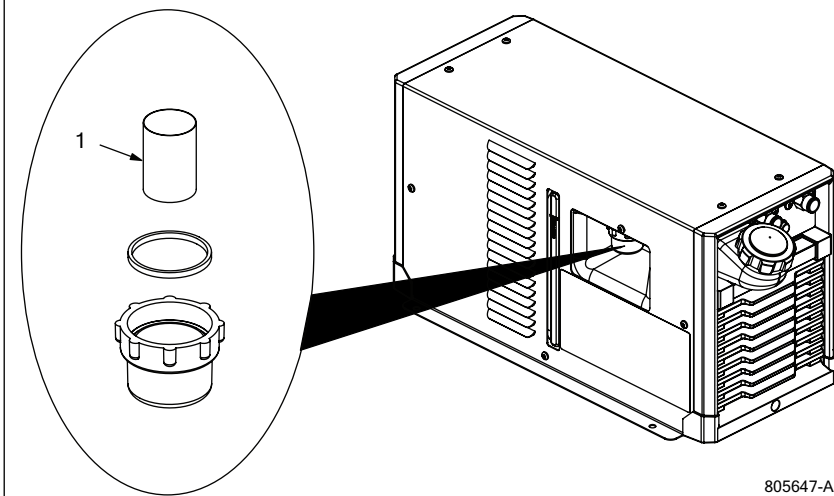

⚠ Disconnect input power before maintaining.

⚠ Dispose of used coolant according to national, state, and local codes. Do not pour down drain.

NOTICE – Do not run cooler without coolant in tank.

1 Coolant Filter

Unscrew housing to clean filter.

Assemble and install cleaned coolant filter.

Changing Coolant

Changing coolant: Drain coolant by removing cap and tipping unit forward, or use suction pump. Fill with clean water and run for 10 minutes. Drain and refill with coolant (see Section 7-4). Install cap.

NOTICE – If replacing hoses, use hoses compatible with ethylene glycol, such as Buna-n, Neoprene, or Hypalon. Oxy-acetylene hoses are not compatible with any product containing ethylene glycol.





7-4. Coolant Specifications



Do not use conductive coolant.

Application	Coolant
GTAW Or Where High Frequency Current Is Used	Low Conductivity Coolant 043810* Distilled Or Deionized Water Okay Above 32°F (0°C)
GMAW Or Where High Frequency Current Is Not Used	Low Conductivity Coolant 043810* Aluminum Protecting Coolant 043809* Distilled Or Deionized Water Okay Above 32°F (0°C)
Where Coolant Contacts Aluminum Parts	Aluminum Protecting Coolant 043809*
*Coolants 043810 and 043809 protect to -37°F (-38°C) and resist algae growth.	
NOTICE – Use of any coolant other than those listed in the table voids the warranty on any parts that come in contact with the coolant (pump, radiator, etc.).	

7-5. Troubleshooting Table

    				
Trouble		Remedy		
No weld output; unit completely inoperative.	Place line disconnect switch in On position (see Section 5-8 or 5-9).			
	Check and replace line fuse(s), if necessary, or reset circuit breaker (see Section 5-8 or 5-9).			
	Check for proper input power connections (see Section 5-8 or 5-9).			
No weld output; meter display On.	If using remote control, be sure correct process is enabled to provide output control at Remote 14 receptacle (see Section 5-10 as applicable).			
	Input voltage outside acceptable range of variation (see Sections 5-6 and 5-7).			
	Check, repair, or replace remote control.			
	Unit overheated. Allow unit to cool with fan On (see Section 4-8).			
Erratic or improper weld output.	Use proper size and type of weld cable (see Section 5-2).			
	Clean and tighten all weld connections (see Section 7-1).			
Fan not operating.	Check for and remove anything blocking fan movement.			
	Have Factory Authorized Service Agent check fan motor.			
Wandering arc.	Use proper size tungsten (see Section 12).			
	Use properly prepared tungsten (see Section 12).			
	Reduce gas flow rate.			
Tungsten electrode oxidizing and not remaining bright after conclusion of weld.	Shield weld zone from drafts.			
	Increase postflow time.			
	Check and tighten all gas fittings (see Section 7-1).			
	Water in torch. Refer to torch manual.			
Blank display.	Verify Power to machine.			
	A software update may be required (see Section 5-12). Contact factory if display remains blank after a software update is performed.			

SECTION 8 – PARTS LIST

8-1. Recommended Spare Parts

Recommended Spare Parts

Dia. Mkgs.	Part No.	Description	Quantity
	239494	Screen, Filter Lp Cyl 100 x 100 x 0.0045 SST A	1
	043810	Coolant	1
	290084	Lens Cover, Replaceable	1

+When ordering a component originally displaying a precautionary label, the label should also be ordered. Labels available separately or as part of label kit.

To maintain the factory original performance of your equipment, use only Manufacturer's Suggested Replacement Parts. Model and serial number required when ordering parts from your local distributor.

SECTION 9 – ELECTRICAL DIAGRAMS

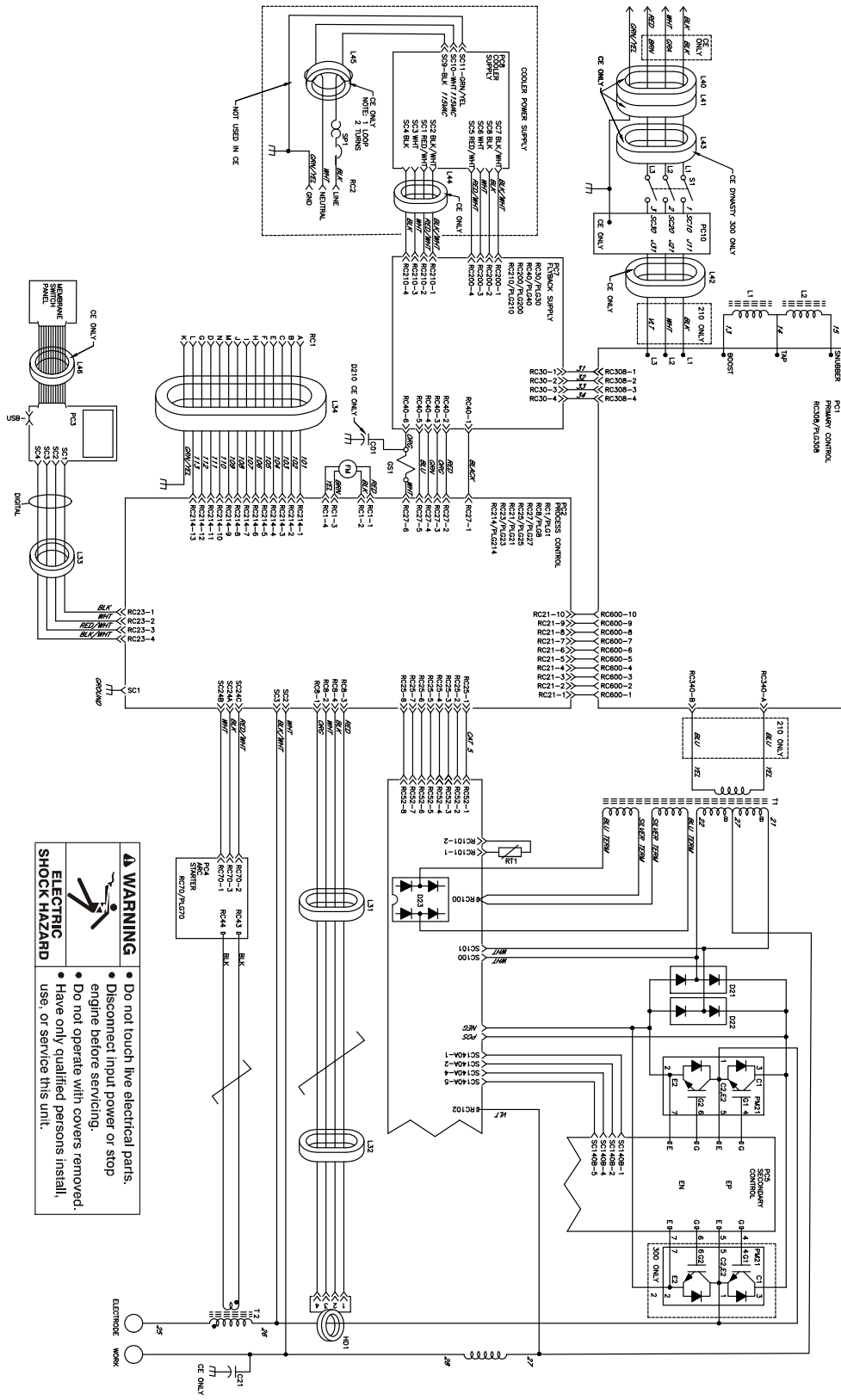
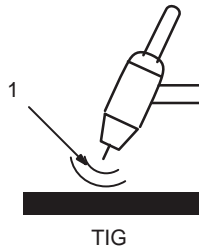

Figure 9-1. Circuit Diagram For Dynasty 210

291496-E

SECTION 10 – HIGH FREQUENCY

10-1. Welding Processes Requiring High Frequency



1 High-Frequency Voltage

TIG – helps arc jump air gap between torch and workpiece and/or stabilize the arc.

10-2. Installation Showing Possible Sources Of HF Interference



Best Practices Not Followed

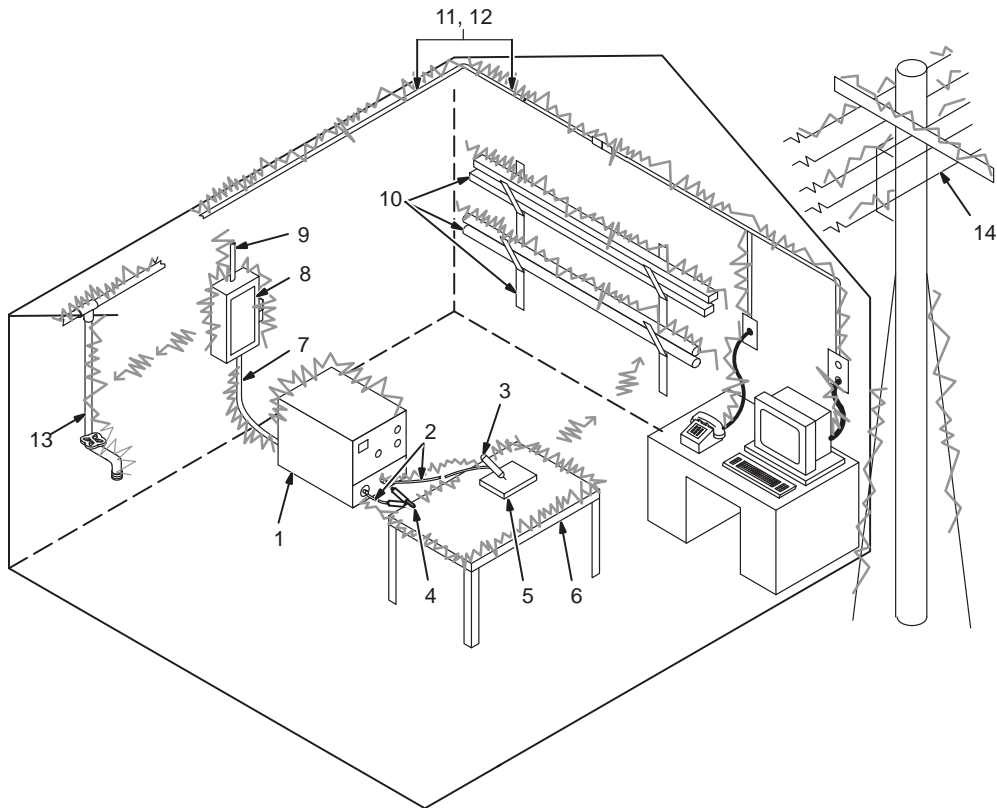

Sources of Direct High Frequency Radiation

- 1 High-Frequency Source (welding power source with built-in HF or separate HF unit)
- 2 Weld Cables
- 3 Torch
- 4 Work Clamp
- 5 Workpiece
- 6 Work Table

Sources of Conduction of High Frequency

- 7 Input Power Cable
- 8 Line Disconnect Device
- 9 Input Supply Wiring

Sources of Reradiation of High Frequency

- 10 Ungrounded Metal Objects
- 11 Lighting
- 12 Wiring
- 13 Water Pipes And Fixtures
- 14 External Phone And Power Lines

10-3. Recommended Installation To Reduce HF Interference



Best Practices Followed

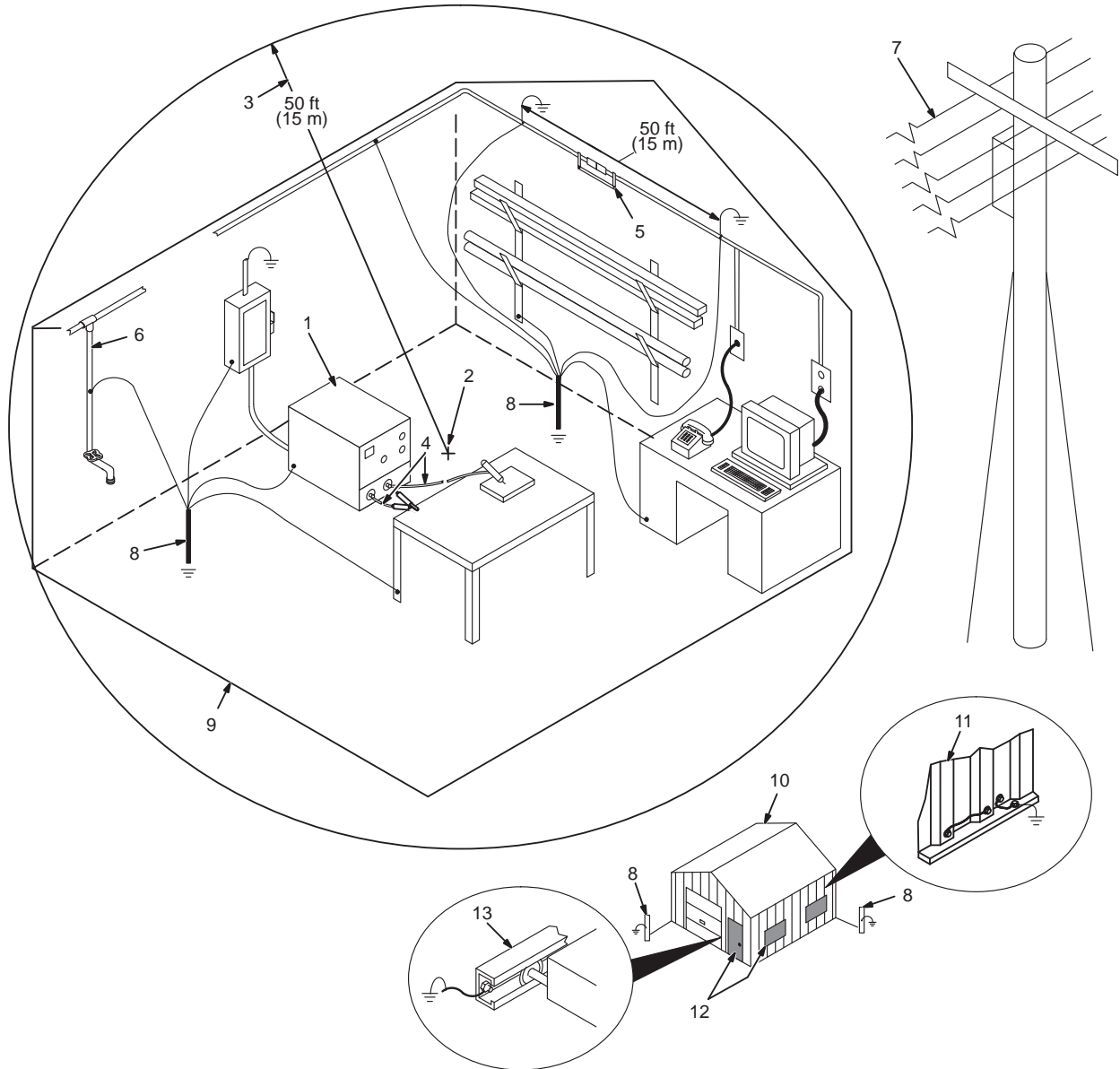

- 1 High-Frequency Source** (welding power source with built-in HF or separate HF unit)

Ground metal machine case (clean paint from around hole in case, and use case screw), work output terminal, line disconnect device, input supply, and worktable.

- 2 Center Point Of Welding Zone**

Midpoint between high-frequency source and welding torch.

- 3 Welding Zone**

A circle 50 ft (15 m) from center point in all directions.

- 4 Weld Output Cables**

Keep cables short and close together.

- 5 Conduit Joint Bonding and Grounding**

Electrically join (bond) all conduit sections using copper straps or braided wire. Ground conduit every 50 ft (15 m).

- 6 Water Pipes and Fixtures**

Ground water pipes every 50 ft (15 m).

- 7 External Power or Telephone Lines**

Locate high-frequency source at least 50 ft (15 m) away from power and phone lines.

- 8 Grounding Rod**

Consult the National Electrical Code for specifications.

Ground all metal objects and all wiring in welding zone using #12 AWG wire.

Ground workpiece if required by codes.

- 9 Nonmetal Building**

Metal Building Requirements

- 10 Metal Building**

- 11 Metal Building Panel Bonding Methods**

Bolt or weld building panels together, install copper straps or braided wire across seams, and ground frame.

- 12 Windows and Doorways**

Cover all windows and doorways with grounded copper screen of not more than 1/4 in (6.4 mm) mesh.

- 13 Overhead Door Track**

Ground the track.

SECTION 11 – TIG PROCEDURES

11-1. Lift-Arc And HF TIG Start Procedures

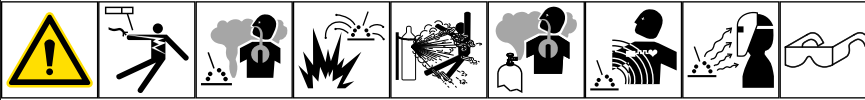

Lift-Arc Start Method

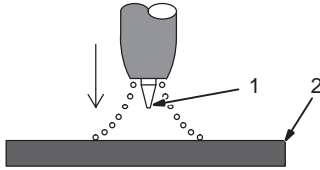

“Touch” 1–2 Seconds

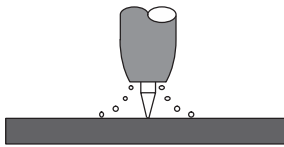

Do NOT Strike Like A Match!

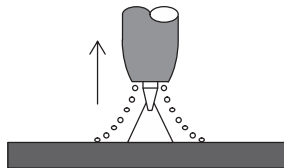

Lift-Arc Start

When Lift-Arc button is selected, start arc as follows:

- 1 TIG Electrode
- 2 Workpiece

Touch tungsten electrode to workpiece at weld start point, enable output and shielding gas with torch trigger, foot control, or hand control. **Hold electrode to workpiece for 1-2 seconds**, and slowly lift electrode. Arc is formed when electrode is lifted.

Normal open-circuit voltage is not present before tungsten electrode touches workpiece; only a low sensing voltage is present between electrode and workpiece. The solid-state output contactor does not energize until after electrode is touching workpiece. This allows a properly prepared electrode (see Section 12) to touch workpiece without overheating, sticking, or getting contaminated.

Application:

Lift-Arc is used for the DCEN or AC GTAW process when HF Start method is not permitted, or to replace the scratch method.

HF Start

When HF Start button is selected, start arc as follows:

High frequency turns on to start arc when output is enabled. High frequency turns off when arc is started, and turns on whenever arc is broken to help restart arc.

Application:

HF start is used for the DCEN GTAW, or the AC GTAW process when a non-contact arc starting method is required.

SECTION 12 – SELECTING AND PREPARING A TUNGSTEN FOR DC OR AC WELDING WITH INVERTER MACHINES

12-1. Selecting Tungsten Electrode



⚠ Whenever possible and practical, use DC weld output instead of AC weld output.
NOTICE – Wear clean gloves to prevent contamination of tungsten.

A. Select Tungsten Electrode

Amperage Range By Gas Type* And Polarity		
Electrode Diameter (2% Ceriated or 1.5% Lanthanum Alloy Tungstens)	DCEN – Argon Direct Current Electrode Negative (For Use With Mild Or Stainless Steel)	AC – Argon Unbalanced Wave (75% EN Balance) (For Use With Aluminum)
0.010 in. (0.25 mm)	Up to 15	Up to 15
0.020 in. (0.50 mm)	5–20	5–20
0.040 in. (1 mm)	15–80	15–80
1/16 in. (1.6 mm)	70–150	70–150
3/32 in. (2.4 mm)	150–200	140–235
1/8 in. (3.2 mm)	250–400	225–325
5/32 in. (4.0 mm)	400–500	300–400
3/16 in. (4.8 mm)	500–750	400–500
1/4 in. (6.4 mm)	750–1000	500–630

*Typical argon shielding gas flow rates are 10 to 25 CFH (cubic feet per hour).
 Figures listed are a guide and are a composite of recommendations from American Welding Society (AWS).

B. Electrode Composition

Tungsten Type	Application Notes
2% Cerium (Gray)	Good all-around tungsten for both AC and DC welding.
1.5–2% Lanthanum (Yellow/Blue)	Excellent low amp starts for AC and DC welding.
Pure Tungsten (Green)	Not recommended for inverters! For best results in most applications, use a sharpened cerium or lanthanum electrode for AC or DC welding.

Not all tungsten electrode manufacturers use the same colors to identify tungsten type. Contact the tungsten electrode manufacturer or reference the product packaging to identify the tungsten you are using.

12-2. Preparing Tungsten Electrode For DC Electrode Negative (DCEN) Welding Or AC Welding With Inverter Machines

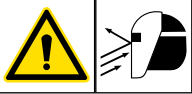

Wrong Tungsten Preparation — Radial Grinding Causes Wandering Arc

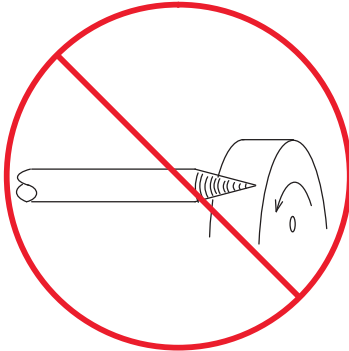

Better Tungsten Preparation — Stable Arc

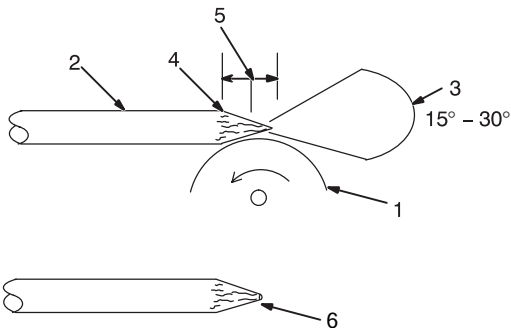

Best Tungsten Preparation — Dedicated Tungsten Grinder

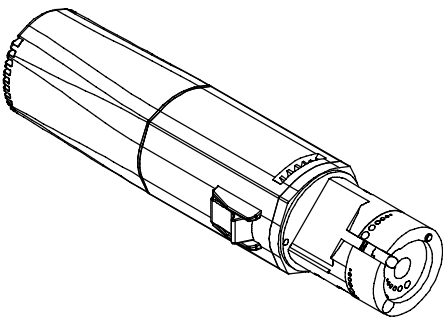

⚠ Grinding the tungsten electrode produces dust and flying sparks which can cause injury and start fires. Use appropriate local exhaust (forced ventilation) at the grinder or wear an approved respirator. Read SDS for safety information. Properly dispose of grinder dust in an environmentally safe way. Wear proper face, hand, and body protection. Keep flammables away.

⚠ Do not use thoriated tungsten. Use tungsten containing ceria, lanthana, or yttria instead of thoria. Grinding dust from thoriated electrodes contains low-level radioactive material.

☞ It is recommended to prepare tungsten with a tungsten grinder designed for that purpose whenever possible.

1 Grinding Wheel

Grind end of tungsten on fine grit, hard abrasive wheel before welding. Do not use wheel for other jobs or tungsten can become contaminated causing lower weld quality.

2 Tungsten Electrode

A 2% ceriated tungsten is recommended.

3 Ideal Grind Angle Range: 15° to 30°

☞ 30 degrees is the recommended electrode grind angle.

4 Straight Ground

Grind lengthwise, not radial.

5 1-1/2 to 4 Times Electrode Diameter

6 Straight Ground Tip

☞ Blunting the tip of the electrode is sometimes done to help maintain consistent geometry and resist tungsten erosion. This is especially helpful in AC when melt-back of the tungsten electrode is common.

SECTION 13 – STICK WELDING (SMAW) GUIDELINES

13-1. Electrode And Amperage Selection Chart

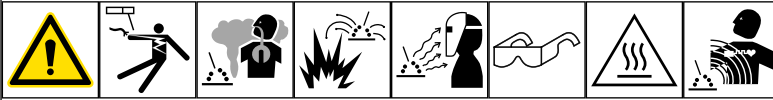

ELECTRODE	DIAMETER	AMPERAGE RANGE								
		50	100	150	200	250	300	350	400	450
6010 & 6011	3/32	█								
	1/8		█							
	5/32			█						
	3/16				█					
	7/32					█				
6013	1/4					█				
	1/16	█								
	5/64		█							
	3/32			█						
	1/8				█					
7014	5/32				█					
	3/16					█				
	7/32						█			
	1/4							█		
	3/32								█	
7018	1/8									
	3/32									
	5/32									
	3/16									
	7/32									
7024	1/4									
	3/32									
	1/8									
	5/32									
	3/16									
Ni-CI	7/32									
	1/4									
	3/32									
	1/8									
	5/32									
308L	3/32									
	1/8									
	5/32									

ELECTRODE	DC*	AC	POSITION	PENETRATION	USAGE
6010	EP		ALL	DEEP	MIN. PREP, ROUGH HIGH SPATTER
6011	EP	✓	ALL	DEEP	
6013	EP,EN	✓	ALL	LOW	GENERAL
7014	EP,EN	✓	ALL	MED	SMOOTH, EASY, FAST
7018	EP	✓	ALL	MED	LOW HYDROGEN, STRONG
7024	EP,EN	✓	FLAT HORIZ*	LOW	SMOOTH, EASY, FASTER
NI-CL	EP	✓	ALL	LOW	CAST IRON
308L	EP	✓	ALL	LOW	STAINLESS

*EP = ELECTRODE POSITIVE (REVERSE POLARITY)
EN = ELECTRODE NEGATIVE (STRAIGHT POLARITY)

TRUE BLUE[®]

WARRANTY



Effective January 1, 2023 (Equipment with a serial number preface of ND or newer)

This limited warranty supersedes all previous Miller warranties and is exclusive with no other guarantees or warranties expressed or implied.

LIMITED WARRANTY - Subject to the terms and conditions below, Miller Electric Mfg. LLC, Appleton, Wisconsin, warrants to authorized distributors that new Miller equipment sold after the effective date of this limited warranty is free of defects in material and workmanship at the time it is shipped by Miller. THIS WARRANTY IS EXPRESSLY IN LIEU OF ALL OTHER WARRANTIES, EXPRESS OR IMPLIED, INCLUDING THE WARRANTIES OF MERCHANTABILITY AND FITNESS.

Within the warranty periods listed below, Miller will repair or replace any warranted parts or components that fail due to such defects in material or workmanship. Miller must be notified in writing within thirty (30) days of such defect or failure, at which time Miller will provide instructions on the warranty claim procedures to be followed. Notifications submitted as online warranty claims must provide detailed descriptions of the fault and troubleshooting steps taken to diagnose failed parts. Warranty claims that lack the required information as defined in the Miller Service Operation Guide (SOG) may be denied by Miller.

Miller shall honor warranty claims on warranted equipment listed below in the event of a defect within the warranty coverage time periods listed below. Warranty time periods start on the delivery date of the equipment to the end-user purchaser, or 12 months after the equipment is shipped to a US or Canada distributor, or 18 months after the equipment is shipped to an international distributor, whichever occurs first.

1 5 Years Parts — 3 Years Labor

- Original Main Power Rectifiers Only to Include SCRs, Diodes, and Discrete Rectifier Modules in non-inverter products

2 4 Years Parts (No Labor)

- Auto-Darkening ClearLight 2.0 Helmet Lenses

3 3 Years — Parts and Labor Unless Specified

- Auto-Darkening Helmet Lenses (No Labor)
- Engine Driven Welder/Generators (Including EnPak) (**NOTE: Engines are Warranted Separately by the Engine Manufacturer.**)
- Insight Welding Intelligence Products (Except External Sensors)
- Inverter Power Sources
- Plasma Arc Cutting Power Sources
- Process Controllers
- Semi-Automatic and Automatic Wire Feeders
- Transformer/Rectifier Power Sources

4 2 Years — Parts and Labor

- Auto-Darkening Weld Masks (No Labor)
- Fume Extractors - Filtair 215, Capture 5, and Industrial Collector Series

5 1 Year — Parts and Labor Unless Specified

- ArcReach Heater
- AugmentedArc, LiveArc, and MobileArc Welding Systems
- Automatic Motion Devices
- Bernard BTB Air-Cooled MIG Guns (No Labor)

- CoolBelt, PAPER Blower, and PAPER Face Shield (No Labor)
- Desiccant Air Dryer System
- Field Options (**NOTE: Field options are covered for the remaining warranty period of the product they are installed in, or for a minimum of one year — whichever is greater.**)
- RFCS Foot Controls (Except RFCS-RJ45)
- Fume Extractors - Filtair 130, MWX and SWX Series, ZoneFlow Extraction Arms and Motor Control Box
- HF Units
- ICE/XT Plasma Cutting Torches (No Labor)
- Induction Heating Power Sources, Coolers (**NOTE: Digital Recorders are Warranted Separately by the Manufacturer.**)
- Insight Sensors
- Load Banks
- Motor-Driven Guns (except Spoolmate Spoolguns)
- Positioners and Controllers
- Racks (For Housing Multiple Power Sources)
- Running Gear/Trailers
- Subarc Wire Drive Assemblies
- Supplied Air Respirator (SAR) Boxes and Panels
- TIG Torches (No Labor)
- Tregaskiss Guns (No Labor)
- Water Cooling Systems
- Wireless Remote Foot/Hand Controls and Receivers
- Work Stations/Weld Tables (No Labor)

6 6 Months — Parts

- 12 Volt Automotive-Style Batteries

7 90 Days — Parts

- Accessories (Kits)
- ArcReach Heater Quick Wrap and Air Cooled Cables
- Canvas Covers
- Induction Heating Coils and Blankets, Cables, and Non-Electronic Controls
- MDX Series MIG Guns
- M-Guns
- MIG Guns, Subarc (SAW) Torches, and External Cladding Heads
- Remote Controls and RFCS-RJ45
- Replacement Parts (No labor)
- Spoolmate Spoolguns

Miller's True Blue[®] Limited Warranty shall not apply to:

1. **Consumable components; such as contact tips, cutting nozzles, contactors, brushes, relays, work station table tops and welding curtains, or parts that fail due to normal wear. (Exception: brushes and relays are covered on all engine-driven products.)**
2. Items furnished by Miller, but manufactured by others, such as engines or trade accessories. These items are covered by the manufacturer's warranty, if any.
3. Equipment that has been modified by any party other than Miller, or equipment that has been

improperly installed, improperly operated or misused based upon industry standards, or equipment which has not had reasonable and necessary maintenance, or equipment which has been used for operation outside of the specifications for the equipment.

4. Defects caused by accident, unauthorized repair, or improper testing.

MILLER PRODUCTS ARE INTENDED FOR COMMERCIAL AND INDUSTRIAL USERS TRAINED AND EXPERIENCED IN THE USE AND MAINTENANCE OF WELDING EQUIPMENT.

The exclusive remedies for warranty claims are, at Miller's option, either: (1) repair; or (2) replacement; or, if approved in writing by Miller, (3) the pre-approved cost of repair or replacement at an authorized Miller service station; or (4) payment of or credit for the purchase price (less reasonable depreciation based upon use). Products may not be returned without Miller's written approval. Return shipment shall be at customer's risk and expense.

The above remedies are F.O.B. Appleton, WI, or Miller's authorized service facility. Transportation and freight are the customer's responsibility. TO THE EXTENT PERMITTED BY LAW, THE REMEDIES HEREIN ARE THE SOLE AND EXCLUSIVE REMEDIES REGARDLESS OF THE LEGAL THEORY. IN NO EVENT SHALL MILLER BE LIABLE FOR DIRECT, INDIRECT, SPECIAL, INCIDENTAL OR CONSEQUENTIAL DAMAGES (INCLUDING LOSS OF PROFIT) REGARDLESS OF THE LEGAL THEORY. ANY WARRANTY NOT PROVIDED HEREIN AND ANY IMPLIED WARRANTY, GUARANTEE, OR REPRESENTATION, INCLUDING ANY IMPLIED WARRANTY OF MERCHANTABILITY OR FITNESS FOR PARTICULAR PURPOSE, ARE EXCLUDED AND DISCLAIMED BY MILLER.

Some US states do not allow limiting the duration of an implied warranty or the exclusion of certain damages, so the above limitations may not apply to you. This warranty provides specific legal rights, and other rights may be available depending on your state. In Canada, some provinces provide additional warranties or remedies, and to the extent the law prohibits their waiver, the limitations set out above may not apply. This Limited Warranty provides specific legal rights, and other rights may be available, but may vary by province.

Warranty Questions?

Call 1-800-4-A-MILLER for your local Miller distributor.

Your distributor also gives you...

Service

You always get the fast, reliable response you need. Most replacement parts can be in your hands in 24 hours.

Support

Need fast answers to the tough welding questions? The expertise of the distributor and Miller is there to help you, every step of the way.

Owner's Record

Please complete and retain with your personal records.

Model Name _____ Serial/Style Number _____

Purchase Date _____ (Date which equipment was delivered to original customer.) _____

Distributor _____

Address _____

City _____

State _____ Zip _____

For Service

Contact a *DISTRIBUTOR* or *SERVICE AGENCY* near you.

Always provide Model Name and Serial/Style Number.

Contact your Distributor for:

Welding Supplies and Consumables

Options and Accessories

Personal Protective Equipment (PPE)

Service and Repair Replacement Parts

Training (Schools, Videos, Books)

Welding Process Handbooks

To locate a Distributor or Service Agency visit
www.millerwelds.com or call 1-800-4-A-Miller

Contact the Delivering Carrier to:

File a claim for loss or damage during shipment.

For assistance in filing or settling claims, contact your distributor and/or equipment manufacturer's Transportation Department.

Miller Electric Mfg. LLC

An Illinois Tool Works Company
1635 West Spencer Street
Appleton, WI 54914 USA

International Headquarters—USA

USA Phone: 920-735-4505
USA & Canada FAX: 920-735-4134
International FAX: 920-735-4125

For International Locations Visit
www.MillerWelds.com

