

IM2033
09/2017
REV01

POWER WAVE C300 CE

OPERATOR'S MANUAL



ENGLISH



THE LINCOLN ELECTRIC COMPANY
22801 St. Clair Ave., Cleveland Ohio 44117-1199 USA
www.lincolnelectric.eu

**THE LINCOLN ELECTRIC COMPANY
EC DECLARATION OF CONFORMITY**



Manufacturer and technical
documentation holder:

The Lincoln Electric Company
22801 St. Clair Ave.
Cleveland Ohio 44117-1199 USA

EC Company:

Lincoln Electric Europe S.L.
c/o Balmes, 89 - 8⁰ 2^a
08008 Barcelona
SPAIN

Hereby declare that welding
equipment:

Power Wave C300 CE, including options and accessories

Product number:

K2865-x
(Sales code may also contain prefixes and suffixes)

Is in conformity with Council
Directives and amendments:

Electromagnetic Compatibility (EMC) Directive 2014/30/EU

Low Voltage Directive 2014/35/EU

Standards:

EN 60974-1:2012, Arc Welding Equipment – Part 1:
Welding Power Sources;

EN 60974-5:2013, Arc Welding Equipment – Part 5:
Wire Feeders;

EN 60974-10:2014, Arc Welding Equipment – Part 10:
Electromagnetic compatibility (EMC) requirements

CE marking affixed in 10

Handwritten signature of Samir Farah in black ink.

Samir Farah, Manufacturer
Compliance Engineering Manager

Handwritten signature of Jacek Stefaniak in black ink.

Jacek Stefaniak, European Community Representative
European Product Manager Equipment

1 August 2017

2 August 2017

MCD234d



THANKS! For having chosen the QUALITY of the Lincoln Electric products.

- Please Examine Package and Equipment for Damage. Claims for material damaged in shipment must be notified immediately to the dealer.
- For future reference record in the table below your equipment identification information. Model Name, Code & Serial Number can be found on the machine rating plate.

Model Name:	
.....	
Code & Serial number:	
.....
Date & Where Purchased:	
.....

ENGLISH INDEX

Safety	1
Installation and Operator Instructions	2
Electromagnetic Compatibility (EMC)	Errore. Il segnalibro non è definito.
Technical Specifications.....	15
WEEE	15
Spare Parts	16
Electrical Schematic.....	16
Accessories	16

Safety



11/04



WARNING

This equipment must be used by qualified personnel. Be sure that all installation, operation, maintenance and repair procedures are performed only by qualified person. Read and understand this manual before operating this equipment. Failure to follow the instructions in this manual could cause serious personal injury, loss of life, or damage to this equipment. Read and understand the following explanations of the warning symbols. Lincoln Electric is not responsible for damages caused by improper installation, improper care or abnormal operation.

	<p>WARNING: This symbol indicates that instructions must be followed to avoid serious personal injury, loss of life, or damage to this equipment. Protect yourself and others from possible serious injury or death.</p>
	<p>READ AND UNDERSTAND INSTRUCTIONS: Read and understand this manual before operating this equipment. Arc welding can be hazardous. Failure to follow the instructions in this manual could cause serious personal injury, loss of life, or damage to this equipment.</p>
	<p>ELECTRIC SHOCK CAN KILL: Welding equipment generates high voltages. Do not touch the electrode, work clamp, or connected work pieces when this equipment is on. Insulate yourself from the electrode, work clamp, and connected work pieces.</p>
	<p>ELECTRICALLY POWERED EQUIPMENT: Turn off input power using the disconnect switch at the fuse box before working on this equipment. Ground this equipment in accordance with local electrical regulations.</p>
	<p>ELECTRICALLY POWERED EQUIPMENT: Regularly inspect the input, electrode, and work clamp cables. If any insulation damage exists replace the cable immediately. Do not place the electrode holder directly on the welding table or any other surface in contact with the work clamp to avoid the risk of accidental arc ignition.</p>
	<p>ELECTRIC AND MAGNETIC FIELDS MAY BE DANGEROUS: Electric current flowing through any conductor creates electric and magnetic fields (EMF). EMF fields may interfere with some pacemakers, and welders having a pacemaker shall consult their physician before operating this equipment.</p>
	<p>CE COMPLIANCE: This equipment complies with the European Community Directives.</p>
	<p>FUMES AND GASES CAN BE DANGEROUS: Welding may produce fumes and gases hazardous to health. Avoid breathing these fumes and gases. To avoid these dangers the operator must use enough ventilation or exhaust to keep fumes and gases away from the breathing zone.</p>
	<p>ARC RAYS CAN BURN: Use a shield with the proper filter and cover plates to protect your eyes from sparks and the rays of the arc when welding or observing. Use suitable clothing made from durable flame-resistant material to protect you skin and that of your helpers. Protect other nearby personnel with suitable, non-flammable screening and warn them not to watch the arc nor expose themselves to the arc.</p>
	<p>WELDING SPARKS CAN CAUSE FIRE OR EXPLOSION: Remove fire hazards from the welding area and have a fire extinguisher readily available. Welding sparks and hot materials from the welding process can easily go through small cracks and openings to adjacent areas. Do not weld on any tanks, drums, containers, or material until the proper steps have been taken to insure that no flammable or toxic vapors will be present. Never operate this equipment when flammable gases, vapors or liquid combustibles are present.</p>
	<p>WELDED MATERIALS CAN BURN: Welding generates a large amount of heat. Hot surfaces and materials in work area can cause serious burns. Use gloves and pliers when touching or moving materials in the work area.</p>
	<p>SAFETY MARK: This equipment is suitable for supplying power for welding operations carried out in an environment with increased hazard of electric shock.</p>

	<p>CYLINDER MAY EXPLODE IF DAMAGED: Use only compressed gas cylinders containing the correct shielding gas for the process used and properly operating regulators designed for the gas and pressure used. Always keep cylinders in an upright position securely chained to a fixed support. Do not move or transport gas cylinders with the protection cap removed. Do not allow the electrode, electrode holder, work clamp or any other electrically live part to touch a gas cylinder. Gas cylinders must be located away from areas where they may be subjected to physical damage or the welding process including sparks and heat sources.</p>
	<p>NOISE APPEARES DURING WELDING CAN BE HARMFUL: Welding arc can cause noise with high level of 85dB for 8-hour week day. Welders operating welding machines are obligated to wear the proper ear protectors /appendix No. 2 for the Decree of the Secretary of Labor and Social Policy from 17.06 1998 – Dz.U. No. 79 pos. 513/. According to the Decree the Secretary of Health and Social Welfare from 09.07.1996 /Dz.U. No. 68 pos. 194/, employers are obligated to carry examinations and measurements of health harmful factors.</p>
	<p>MOVING PARTS ARE DANGEROUS: There are moving mechanical parts in this machine, which can cause serious injury. Keep your hands, body and clothing away from those parts during machine starting, operating and servicing.</p>

Installation and Operator Instructions

Read this entire section before installation or operation of the machine.

Location and Environment

THE POWER WAVE® C300CE will operate in harsh environments. Even so, it is important that simple preventative measures are followed in order to assure long life and reliable operation.

- The machine must be located where there is free circulation of clean air such that air movement in the back, out the sides and bottom will not be restricted.
- Dirt and dust that can be drawn into the machine should be kept to a minimum. The use of air filters on the air intake is not recommended because normal air flow may be restricted. Failure to observe these precautions can result in excessive operating temperatures and nuisance shutdown.
- Keep machine dry. Shelter from rain and snow. Do not place on wet ground or in puddles.
- Do not mount the POWER WAVE® C300 CE over combustible surfaces. Where there is a combustible surface directly under stationary or fixed electrical equipment, that surface shall be covered with a steel plate at least 1.6mm thick, which shall extend not less than 150mm beyond the equipment on all sides.

Lifting

WARNING

FALLING EQUIPMENT can cause injury.

Lift only with equipment of adequate lifting capacity.

- Be sure machine is stable when lifting.
- Do not operate machine while suspended when lifting.

Both handles should be used when lifting POWER WAVE® C300 CE. When using a crane or overhead device a lifting strap should be connected to both handles. Do not attempt to lift the POWER WAVE® C300 CE with accessories attached to it.

Stacking

The POWER WAVE® C300 CE cannot be stacked.

Tilting

Place the machine directly on a secure, level surface or on a recommended undercarriage. The machine may topple over if this procedure is not followed.

Duty Cycle and Overheating

The POWER WAVE® C300 CE is rated at 250A - 26.5V @ 100% duty cycle. It is further rated to provide 300A – 29V @ 40% duty cycle.

The duty cycle is based on a ten-minute period. A 40% duty cycle represents 6 minutes of welding and 4 minutes of idling in a 10-minute period.

Example: 40% Duty Cycle:

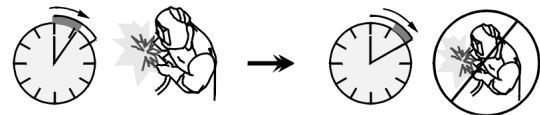

Welding for 4 minutes.

Break for 6 minutes.

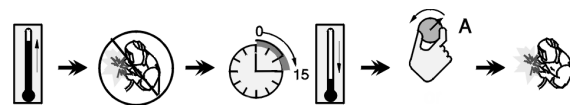

Minutes

or decrease
Duty Cycle

Preparation for Work

Input and Ground Connections

WARNING

Only a qualified electrician should connect the input leads to the POWER WAVE® C300 CE. Connections should be made in accordance with all local and national electrical codes and the connection diagram located on the inside of the reconnect access door of the machine. Failure to do so may result in bodily injury or death.

Machine Grounding

The frame of the welder must be grounded. A ground terminal marked with a ground symbol is located next to the input power connection block. See your local and

national electrical codes for proper grounding methods.

High Frequency Protection

The EMC classification of the POWER WAVE® C300 CE is Industrial, Scientific and Medical (ISM) group 2, class A. The POWER WAVE® C300 CE is for industrial use only (see **Electromagnetic Compatibility EMC Safety Section**).

Locate the POWER WAVE® C300 CE away from radio controlled machinery. The normal operation of the POWER WAVE® C300 CE may adversely affect the operation of RF controlled equipment, which may result in bodily injury or damage to the equipment.

Input Connection

- 4.6m power cord is provided and wired into the machine.
- **Single Phase Input** - Not supported.
- **Three Phase Input** - Connect green/yellow lead to ground per National Electric Code. Connect grey, brown and black leads to power.
- The POWER WAVE® C300 CE automatically adjusts to work with different input voltages. No reconnect switches settings are required.

⚠ WARNING

The POWER WAVE® C300 CE ON/OFF switch is not intended as a service disconnect for this equipment.

Power Cord Replacement

If the input power cord is damaged or needs to be replaced an input power connection block is located in the access panel under the wire spool.

⚠ WARNING

ALWAYS CONNECT THE POWER WAVE GROUNDING LUG (LOCATED INSIDE THE ACCESS PANEL) TO A PROPER SAFETY (EARTH) GROUND.

Shielding Gas Connection

Customer must provide a cylinder of shielding gas, a pressure regulator, any flow control valve.

Connect a supply hose from the gas cylinder flow valve outlet to the 5/8-18 female inert gas fitting on the back panel of the POWER WAVE® C300 CE.

- **MAXIMUM INLET PRESSURE IS 6.9 BAR.**

Procedure to Install Drive Rolls and Wire Guides

1. Turn power off at the welding power source.
2. Release the idle roll pressure arm.
3. Remove the outer wire guide by turning the knurled thumbscrews counter-clockwise to unscrew them from the feed plate.
4. Rotate the triangular lock and remove the drive rolls (See Figure 1).

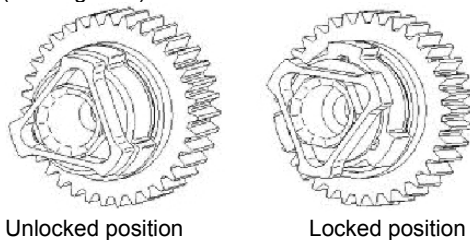

Figure 1

5. Remove the inner wire guide.
6. Insert the new inner wire guide, groove side out, over the two locating pins in the feed plate.
7. Install a drive roll on each hub assembly secure with the triangular lock.
8. Install the outer wire guide by aligning it with the pins and tightening the knurled thumbscrews.
9. Close the idle arm and engage the idle roll pressure arm. Adjust the pressure appropriately.

Pressure Arm Adjustment

The pressure arm controls the amount of force the drive rolls exert on the wire. Proper adjustment of the pressure arm gives the best welding performance.

Set the pressure arm as follows (see Fig 2):

- Aluminum wires: between 1 and 3
- Cored wires: between 3 and 4
- Steel, Stainless wires: between 4 and 6

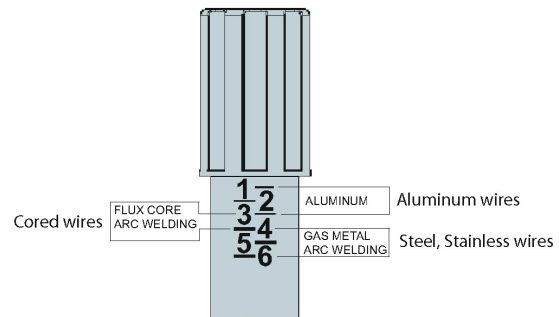

Figure 2

Operation – General

Power-up Sequence

When the POWER WAVE® C300 CE is powered it can take as long as 30 seconds for the machine to be ready to weld. During this time period the user interface will not be active.

Product Description

The POWER WAVE® C300 CE is a high performance multi-process machine with GMAW, FCAW, SMAW, DC TIG, and pulse capability. It will offer a premier welding performance solution for specific areas such as aluminum, stainless, nickel where size and weight are an issue.

The POWER WAVE® C300 CE will provide the following:

- Power - 300A @ 40%, 250A @ 100%.
- Multi Input Voltage with no reconnect - 208-575V, 50-60 Hz input, 3Phase Power.
- < 95% Power factor – optimizes available electrical capacity.
- Environmentally Hardened - IP23 rated for operating in difficult environments.
- Ethernet connectivity – allows access to the Power Wave utilities software tools.
- Line Voltage Compensation.
- ArcLink® platform.
- Electronic over current protection.
- Input over voltage protection.
- F.A.N. (fan as needed). Cooling fan runs when the

output is energized 15 seconds following the strike of the welding arc and will continue to run 5 minutes following the end of the weld.

The following capabilities are supported:

- Push-pull (12-pin) connection - Panther™ and Cougar™.
- Remote foot pedal or hand amptrol.
- Standard MIG gun trigger connection.
- Watercooler CoolArc 50.

⚠ WARNING

The POWER WAVE® C300 CE is not recommended for pipe thawing.

Equipment Limitations

- Maximum spool size is 305mm diameter.
- Maximum spool weight is 20kg.
- Wire welding processes are limited to positive polarity only.
- Does not operate on single phase power.

Case Front Controls

All operator controls and adjustments are located on the case front of the Power Wave.

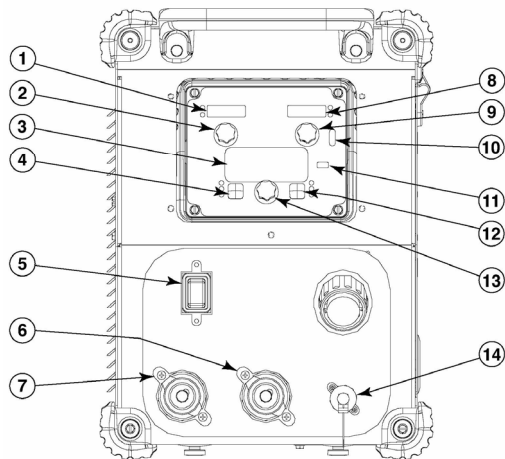

Figure 3

1. **Left Display** - Shows wire feed speed or amperage.
2. **Left Knob** - Adjusts value in left display.
3. **Main Display** - Shows detailed welding and diagnostic information.
4. **Left Button** - Changes the Main display to show the Weld Mode, Inductance or UltimArc™ Control or Memories.
5. **On/Off Switch** - Controls power to the Power Wave C300CE.
6. **“+” Output Stud** - Connection for electrode positive.
7. **“-” Output Stud** - Connection for electrode negative.
8. **Right Display** - Shows voltage or trim.
9. **Right Knob** - Adjusts value in right display.

10. **Thermal Light** - Indicates when machine has thermal fault.
11. **Set-Up** - Lights when machine is in set-up mode.
12. **Right Button** - Changes the Main display to arc start, arc end and trigger options.
13. **MAIN KNOB** - Changes the values on the Main display.
14. **12-pin Connector** - Connection for cross switch gun, push pull guns, remotes.

Case Back Controls

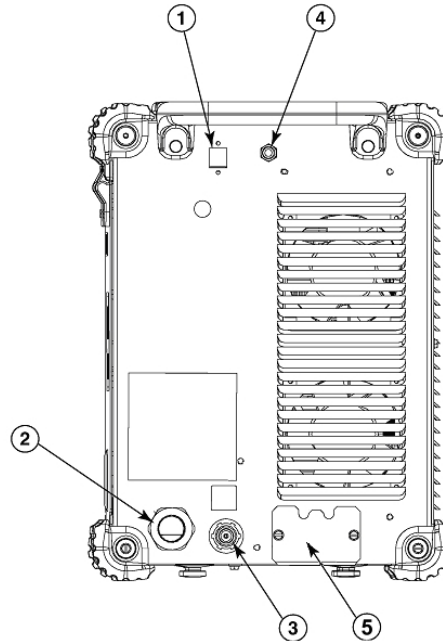

Figure 4

1. **Ethernet Connector**
2. **Power Cord**
3. **Gas Connection**
4. **Circuit Breaker**
5. **Cooler connections**

Internal Controls

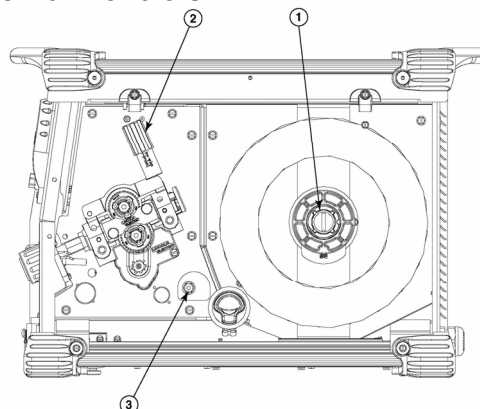

Figure 5

1. Spindle Brake
2. Wire Drive Pressure Arm
3. Cold Inch / Gas Purge Switch

Definition of Welding Modes

Non-Synergic Welding Modes

- A Non-synergic welding mode requires all welding process variables to be set by the operator.

Synergic Welding Modes

- A Synergic welding mode offers the simplicity of single knob control. The machine will select the correct voltage and amperage based on the wire feed speed (WFS) set by the operator.

Basic Welding Controls Weld Mode

Selecting a weld mode determines the output characteristics of the Power Wave power source. Weld modes are developed with a specific electrode material, electrode size, and shielding gas. For a more complete description of the weld modes programmed into the Power Wave at the factory, refer to the Weld Set Reference Guide supplied with the machine or available at www.powerwavesoftware.com.

Wire Feed Speed (WFS)

In synergic welding modes (synergic CV, GMAW-P), WFS is the dominant control parameter. The user adjusts WFS according to factors such as wire size, penetration requirements, heat input, etc. The Power Wave then uses the WFS setting to adjust the voltage and current according to settings contained in the Power Wave. In non-synergic modes, the WFS control behaves like a conventional power source where WFS and voltage are independent adjustments. Therefore, to maintain proper arc characteristics, the operator must adjust the voltage to compensate for any changes made to the WFS.

Amps

In constant current modes, this control adjusts the welding current.

Volts

In constant voltage modes, this control adjusts the welding voltage.

Trim

In pulse synergic welding modes, the Trim setting adjusts the arc length. Trim is adjustable from 0.50 to 1.50. 1.00 is the nominal setting and is a good starting point for most conditions.

Inductance and UltimArc™ Control

UltimArc™ Control allows the operator to vary the arc characteristics from “soft” to “crisp”. UltimArc™ Control is adjustable from -10.0 to +10.0 with a nominal setting of 0.0.

SMAW (Stick) Welding

SMAW is most often used for outdoor construction, pipe welding and general repairs. The POWER WAVE® C300 CE controls Amperage, Output Control and Arc

Force during SMAW welding.

During SMAW welding the wire drive remains idle.

Basic Operation

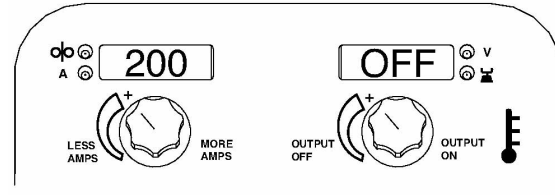

CC STICK MODE	
Process	Mode
Stick Soft (7018)	1
Stick Crisp (6010)	2
Stick Pipe	4

Non-Synergic GMAW and FCAW Welding

In non-synergic modes, the WFS control is similar to a conventional CV power source where WFS and voltage are independent adjustments. Therefore to maintain the arc characteristics, the operator must adjust the voltage to compensate for any changes made to the WFS.

UltimArc™ Control, adjusts the apparent inductance of the wave shape. The UltimArc™ Control adjustment is similar to the “pinch” function in that it is inversely proportional to inductance. Therefore, increasing UltimArc™ Control greater than 0.0 results in a crisper arc (more spatter) while decreasing the UltimArc™ Control to less than 0.0 provides a softer arc (less spatter).

Basic Operation

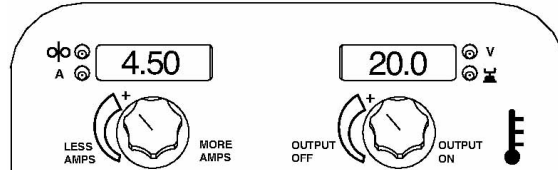

WELD MODE	
Process	Mode
GMAW, STANDARD CV	5
GMAW, POWER MODE	40
FCAW, (SS) STANDARD CV	6
FCAW, (GS) STANDARD CV	7

GMAW (MIG) Synergic Welding

In synergic welding modes, WFS is the dominant control parameter. For each wire feed speed, a corresponding voltage is programmed into the machine at the factory. The user adjusts WFS according to factors such as wire size, material thickness, penetration requirements, etc. The Power Wave then uses the WFS setting to select the appropriate voltage. The voltage selected will be a nominal voltage. The user can adjust the voltage higher or lower to compensate for material condition or individual preference.

UltimArc™ Control, adjusts the apparent inductance of the wave shape. The UltimArc™ Control adjustment is similar to the “pinch” function in that it is inversely

proportional to inductance. Therefore, increasing UltimArc™ Control greater than 0.0 results in a crisper arc (more spatter) while decreasing the UltimArc™ Control to less than 0.0 provides a softer arc (less spatter).

Synergic CV programs feature an ideal voltage best suited for most procedures. Use this voltage as a starting point and adjust if needed for personal preferences.

When the voltage knob is rotated, the display will show an upper or lower bar indicating if the voltage is above or below the ideal voltage.

- Preset voltage above ideal voltage (upper bar displayed).
- Preset voltage at ideal voltage (no bar displayed).
- Preset voltage below ideal voltage (lower bar displayed).

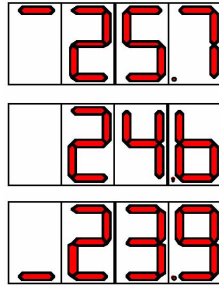

Basic Operation

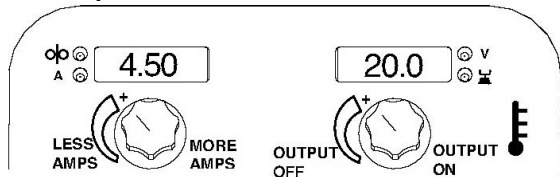

WELD MODE					
Electrode	Gas	Wire Size			
		0,8	0,9	1,0	1,2
Steel	CO ₂	93	14	10	20
Steel	ArMIX	94	15	11	21
Stainless	ArCO ₂	61	29	31	41
Stainless	Ar/He/CO ₂	63	-	33	43
Aluminum AISi	Ar	-	-	-	71
Aluminum AlMg	Ar	-	-	151	75
MetalCore	ArMIX	-	-	-	81
CordWire	CO ₂	-	-	-	90
CordWire	ArMIX	-	-	-	91

Steel and Stainless Synergic GMAW-P (Pulsed MIG)

Pulse welding modes are synergic; using wire feed speed as the main control parameter. As the wire feed speed is adjusted, the power source adjusts the waveform parameters to maintain good welding characteristics. Trim is used as a secondary control to change the arc length for material conditions or individual preference (see Figure 6).

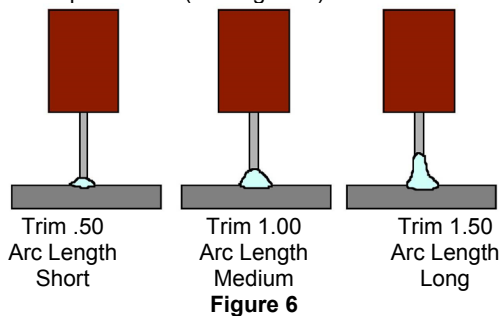
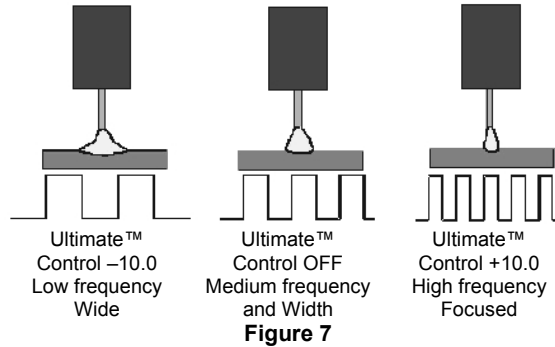

Figure 6

UltimArc™ Control

UltimArc™ Control adjusts the focus or shape of the arc. UltimArc™ Control is adjustable from -10.0 to +10.0 with a nominal setting of 0.0. Increasing the arc control increases the pulse frequency and background current while decreasing the peak current.

This results in a tight, stiff arc used for high speed sheet metal welding. Decreasing the arc control decreases the pulse frequency and background current while increasing the peak current. This results in a soft arc good for out of position welding.



The Power Wave utilizes adaptive control to compensate for changes in the electrical stick-out (distance from the contact tip to the work piece) while welding. The Power Wave waveforms are optimized for a 1,6 to 1,9mm stick out depending on the wire type and wire feed speed.

The adaptive behaviour supports a range of stick outs from approximately 1,27 to 3,1mm. At low or high wire feed speeds, the adaptive range may be less due to physical limitations of the welding process.

Steel and Stainless GMAW-P (Pulsed MIG) Welding

Basic Operation

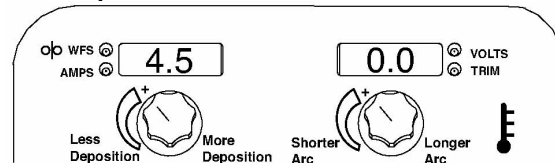

WELD MODE						
Electrode	Gas	Wire Size				
		0,8	0,9	1,0	1,2	1,4
Steel (Crisp)	ArMIX	95	16	12	22	-
Steel (Rapid Arc)	ArMIX	-	17	13	18	-
Steel (Vertical Up)	ArMIX	-	-	-	32	-
Stainless	ArCO ₂	66	-	36	46	-
Stainless (Vertical Up)	Ar/He/CO ₂	64	-	34	44	-
MetalCore	ArMIX	-	-	-	82	84
Ni Alloy	70Ar/30He	-	-	170	175	-
Si Bronze	Ar	-	-	192	-	-
Copper	ArHe	-	-	195	196	-

Aluminium Synergic GMAW-P (Pulsed MIG) and GMAW-P (Pulse on Pulse) Welding

Pulse-on-Pulse Welding

The Power Wave system offers both traditional pulse and Pulse-on-Pulse™. Pulse-on-Pulse (GMAW-PP) is an exclusive waveform for aluminium welding. Use it to make welds with a "stacked dime" appearance, similar to GTAW welds (see Figure 8).

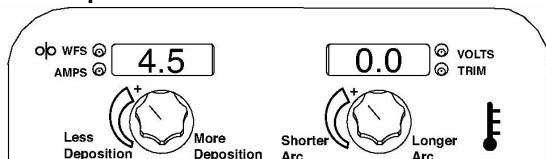

Figure 8

The pulsing frequency is adjustable. Changing the frequency modulation (or arc control) of the waveform changes the ripple spacing. Faster travel speeds may be achieved by using higher values of frequency modulation.

Aluminium GMAW-P (Pulsed MIG) and GMAW-PP (Pulse on Pulse) Welding

Basic Operation



WELD MODE				
Electrode	Gas	Wire Size		
		1,0	1,2	1,6
Aluminum AlSi Pulse	Ar	-	72	74
Aluminum AlSi P-P	Ar	98	99	-
Aluminum AlMg Pulse	Ar	152	76	78
Aluminum AlMg P-P	Ar	101	102	103

GTAW (TIG) Welding

The POWER WAVE® C300 CE is excellent for (Touch Start TIG) welding, a torch with an integral gas valve.

Basic Operation

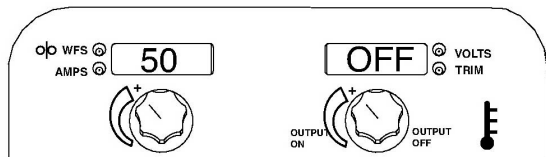

TIG MODE	
Process	Mode
TIG Lift	3
TIG Lift Pulse	8

Saving a Memory

To save the current machine settings to the selected memory, **press and hold the centre knob for 2 seconds**. After 2 seconds, the alphanumeric displays will show "**Memory # Save Memory**" at which time the centre knob should be released. After saving to a memory, a message will briefly appear indicating that the selected memory has been saved.

There are eight procedure memory locations available.

1. Press the Left Push Button until Memory 'M' LED is illuminated.

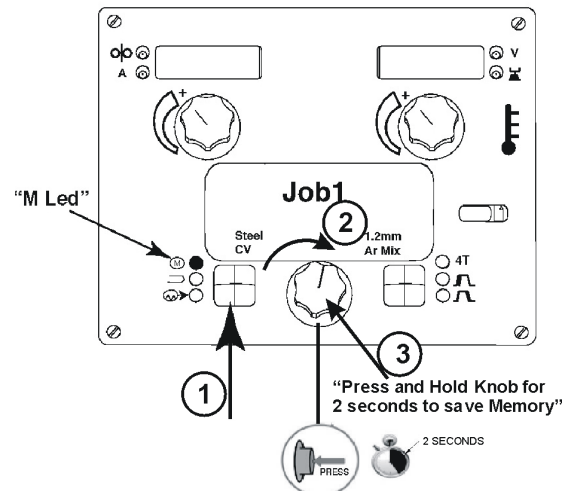

2. Rotate centre knob to cycle to desired memory location.
3. Press and hold centre knob for 2 seconds. The active procedure will be saved into the selected memory.

Recalling a Memory

To recall the selected memory, **press and hold centre knob for (1 second)**. After recalling a memory, a message will briefly appear indicating that the selected memory has been recalled. The **Memory LED** will remain lit so that the user can quickly recall a different memory if needed.

1. Press the Left Push Button until Memory 'M' LED is illuminated.

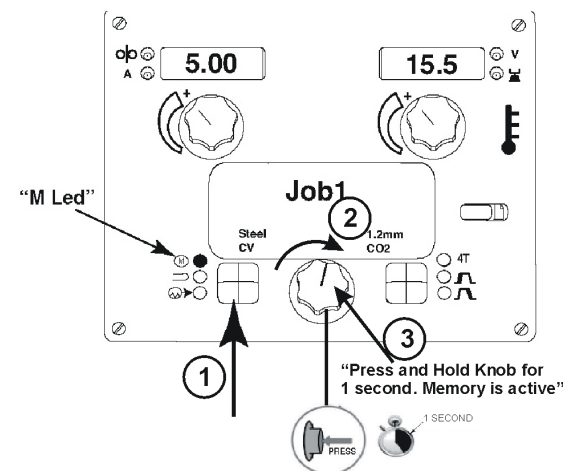

2. Rotate centre knob to cycle to desired memory location.
3. Press and hold centre knob for 1 second. The selected memory is now active.

Limits

Limits allow the welder to adjust the welding procedure only within a defined range.

Each user memory may have a different set of limits. For example, memory 1 can be set to limit the WFS to 5 through 6 m/min, and memory 2 can be set to limit the WFS to 7 through 7.9 in/min, while memory 3 may not have any WFS limits.

Parameters are always constrained by machine limits. When memory limits are enabled, the parameter will flash whenever an attempt is made to exceed the memory limit value. The parameter will not flash if an attempt is made to exceed the machine limit.

The system machine limits are:

Parameter	Range	Units
Wire Feed Speed	Weld mode and wire	in/min
Voltage	Weld mode dependent	Volts
Trim	0.50 to 1.50	---
UltimArc™ Control	-10.0 to 10.0	Weld mode dependent

Limits may be set for:

- Wire Feed Speed/Amperage
- Voltage/Trim
- UltimArc™ Control

Weld modes cannot be selected through the Limits Setup menu, and must be chosen and saved to memory before entering the Limits Setup Menu.

To active Limits Setup Menu:

1. Press the Left Push Button until Memory 'M' LED is illuminated.

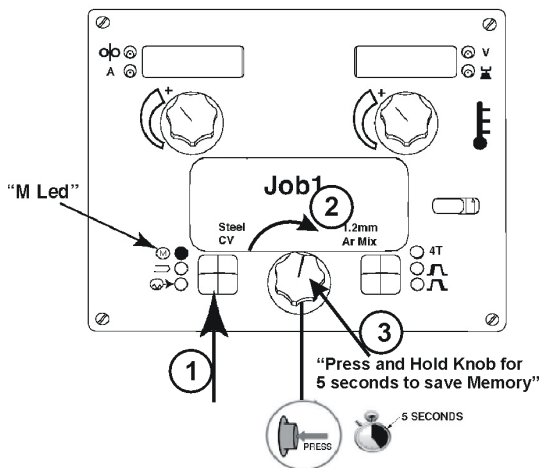

2. Rotate center knob to cycle to desired memory.
3. Press and hold center knob for 5 seconds. The Set Limits Menu will be active.

To Setup Limits:

1. Rotate centre knob to select parameter to be set (WFS, Voltage, Trim).

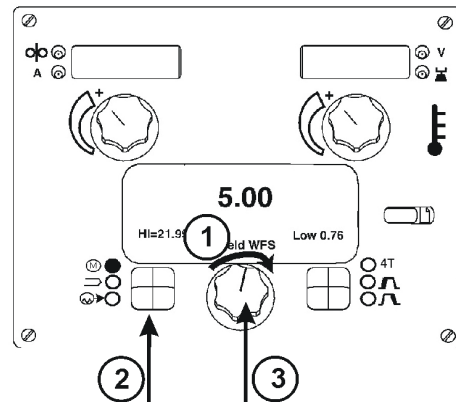

2. Press the Left pushbutton to select the limit to be set (High, Nominal, Low). The selected value will blink.
3. Once all limits have been set, press and hold for 1 second, release the centre knob to accept changes.

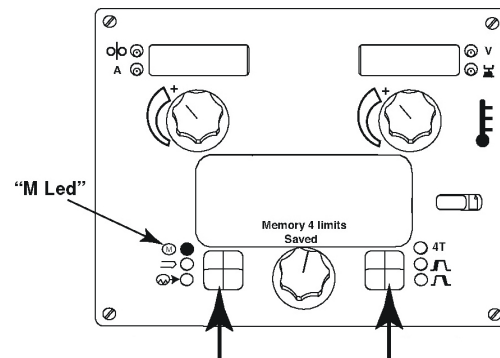

4. Press the left push button to confirm changes (or press the right push button to cancel).

Weld Mode Search

The Weld Mode search function allows for a particular mode to be selected based on the process, wire type and wire size.

1. Press the Left Push Button until Weld Mode LED is illuminated.

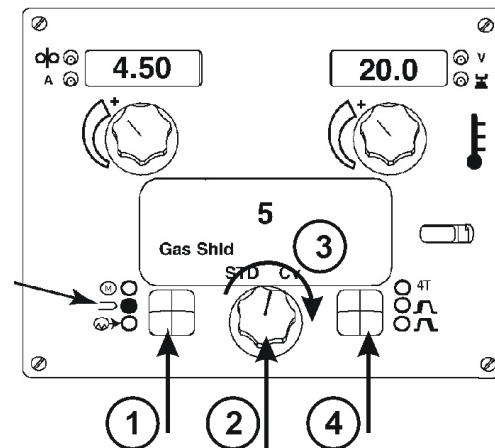

- Press and hold the centre knob for 1 second release centre knob. The Weld Mode search menu will be active.
- Rotate centre knob to cycle to desired process.
- Press the right Push Button to select the process. If necessary, repeat steps 3 and 4 to select wire type, wire size, and final selection.

2-step 4-step - Trigger Operation

The **2-Step - 4-Step** switch changes the function of the gun trigger. **2-Step** trigger operation switches the welding output ON-OFF in direct response to the trigger. **4-Step** trigger operation provides 'trigger interlock' capability and gives the ability to control the amount of time spent in the arc start and arc crater steps.

Press the right push button on the case front to toggle between **2-Step** and **4-Step** operation.

The **2-Step, 4-Step** trigger has no effect when welding with SMAW.

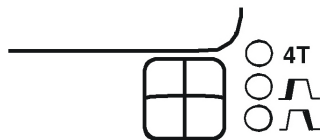

2-Step Trigger

2-Step trigger operation is the most common. When the gun trigger is pulled, the welding system (power source and wire feeder) cycles through the arc starting sequence and into the main welding parameters. The welding system will continue to weld as long as the gun trigger is activated. Once the trigger is released, the welding system cycles through the arc ending steps.

4-Step Trigger

4-Step trigger operation gives the welder additional control in the welding sequence. **4-Step** trigger allows the welder to choose the arc start, weld and arc end time. It may also be set-up to work as a trigger interlock.

Cold Feed/Gas Purge Switch

Cold Feed and Gas Purge are combined into a single spring centered toggle switch.

To activate Cold Feeding, hold the switch in the **UP** position. The wire drive will feed electrode but neither the power source nor the gas solenoid will be energized. Adjust the speed of cold feeding by rotating the WFS knob. Cold feeding, or "cold inching" the electrode is useful for threading the electrode through the gun.



Hold with toggle switch in the **DOWN** position to activate Gas Purge and let the shielding gas flow.

Set-Up Features Menu

The Setup Menu gives access to the set-up configuration. Stored in the set-up configuration are user parameters that generally need to be set only at installation. The parameters are grouped as follows:

- P.1 through P.79 Unsecured Parameters (always adjustable).
- P.79 through P.199 Diagnostic Parameters (always read only).
- P.501 through P.599 Secured Parameters (accessible only through Power Wave Manager).

To access the set-up menu, press the right and left buttons of the MSP4 panel simultaneously. Note that the set-up menu cannot be accessed if the system is welding, or if there is a fault (The status LED is not solid green). Change the value of the blinking parameter by rotating the SET knob.

After changing a parameter it is necessary to press the right hand button to save the new setting. Pressing the left button will cancel the change. To exit the set-up menu at any time, press the right and left buttons of the MSP4 panel simultaneously. Alternately, 1 minute of inactivity will also exit the setup menu.

List of Unsecured Parameters

P.0	Exit Setup Menu
P.1	Wire Feed Speed Units
P.2	Arc Display Mode
P.3	Display Energy
P.4	Recall Memory with Trigger
P.5	Procedure Change Method
P.6	Stall Factor Adjustment
P.7	Gun Offset Adjustment
P.8	TIG Gas Control
P.9	Crater Delay
P.14	Reset Consumable Weight
P.16	Push-Pull Gun Knob Behaviour
P.17	Remote Control
P.20	Display Trim as Volts Option
P.22	Arc Start/Loss Error Time
P.25	Joystick Configuration
P.26	Show Memory Led

List of Diagnostic Parameters

P.80	Sense From Studs
P.82	Voltage Sense Display
P.99	Show Test Modes?
P.100	View Diagnostics
P.101	View Event Logs
P.102	View Fatal Logs
P.103	View Software Version Info
P.104	View Hardware Version Info
P.105	View Welding Software Info
P.106	View Ethernet IP Address
P.107	View Power Source Protocol

List of Secured Parameters accessible through Power Wave Manager only

P.500	View Lockout Parameters
P.501	Encoder Lockout
P.502	Memory Change Lockout
P.503	Memory Button Disable
P.504	Mode Select Panel Lock
P.505	Setup Menu Lock
P.506	Set User Interface Passcode
P.509	UI Master Lockout

Detailed description of Setup programs

Unsecured Parameters

P.0 Press the left button to exit the set-up menu.

P.1 WFS units

- Metric = m/min wire feed speed units
- English = in/min wire feed speed units (default)

P.2 Arc Display Mode

- Amps = The left display shows Amperage while welding. (default)
- WFS = The left display shows Wire Feed Speed while welding.

P.3 Display Energy

P.3 selects whether or not energy is displayed on the MSP4 while welding. The total energy from the previous weld will persist on the MSP4 display until another weld is started, or a user interface control is changed. P.3 will only show up in the list if the power source is capable of calculating energy (a power source software update may be necessary). When P.3 = No, energy will not be displayed (default). When P.3 = Yes, energy is displayed.

P.4 Trigger Memory Recall

- Enable = Selecting memories 2 through 6 with quick trigger pulls is enabled when the optional dual procedure/memory panel is installed. To recall a memory with the gun trigger, quickly pull and release the trigger the number of times that correspond to the memory number. For example, to recall memory 3, quickly pull and release the trigger 3 times. Trigger memory recall can only be performed when the system is not welding.
- Disable = Memory selection is performed only by the buttons on the optional dual procedure/memory panel (default).

P.5 Trigger Procedure Change

- Quick Trigger = Allows switching between Procedure A and procedure B while welding. The optional dual procedure/memory panel is required. To operate:
 - Select procedure "GUN" on the memory panel.
 - Start the weld by pulling the gun trigger. The system will weld with procedure A settings.
 - While welding, quickly release and then pull the gun trigger. The system will switch to procedure B settings.
 - Release the trigger to stop welding. When the next weld is made, the system will start again with procedure A.
- Integral TrigProc = Use Integral Trigger + Procedure Switch when using a Lincoln Dual Schedule gun. When in 2-step, the system operates identical to the External Switch selection. To operate in 4-step:
 - Select procedure "GUN" on the memory panel.
 - Start the weld by pulling the gun trigger. The system will weld with procedure A settings.
 - While welding, quickly release and then pull the gun trigger. The system will switch to procedure B settings.
 - Release the trigger to stop welding. When the next weld is made, the system will start again with procedure A.
- External Switch = Dual Procedure selection may only be performed by the memory panel button or a dual procedure gun (default).

P.6 Push Pull Gun, Stall Factor Adjustment

The stall factor controls the stall torque of the push motor when using a push-pull gun. The wire feeder is factory set to not stall unless there is a large resistance to feeding wire. The stall factor can be reduced to stall more easily and possibly prevent bird nesting. However,

low stall factors can cause motor stalling while welding which results in the wire burning back to the tip. If you are experiencing bird nests, check for other feeding problems before adjusting the stall factor. Default value for the stall factor is 75, with a range of 5 - 100. To change the stall factor:

- Use the VOLTS/TRIM knob to adjust the stall factor. Increasing the stall factor raises the motor torque and decreasing the stall factor lowers the motor torque. Do not increase the stall factor more than necessary. A high stall factor may increase the occurrence of bird nesting and a low stall factor may cause the wire to burn back to the tip.
- Press the right hand button to save the new setting.

P.7 Push Pull Gun, Gun Offset Adjustment

The push-pull gun offset calibration adjusts the wire feed speed calibration of the pull motor. The procedure should only be performed when other possible corrections do not solve the push-pull feeding problems. A rpm meter is required to perform the pull gun motor offset calibration. To perform the calibration procedure:

- Release the pressure arm on both the pull and push wire drives.
- Set the wire feed speed to 200 rpm.
- Remove wire from the pull wire drive.
- Hold the rpm meter to the drive roll in the pull gun.
- Pull the trigger on the push-pull gun.
- Measure the rpm of the pull motor. The rpm should be between 115 and 125 rpm. If necessary, decrease the calibration setting to slow the pull motor, or increase the calibration setting to speed up the motor. The calibration range is -30 to +30, with 0 as the default value.
- Press the right hand button to save the new setting.

P.8 TIG Gas Control

Allows control over which gas solenoid actuates while TIG welding.

- Valve (manual) = No MIG solenoid will actuate while TIG welding, gas flow is manually controlled by an external valve.
- Feeder Solenoid = The internal (feeder) MIG solenoid will turn on and off automatically while TIG welding.
- Power source Solenoid = Any gas solenoid connected to the power source will turn on and off automatically while TIG welding.

Notes:

- Preflow is not available while TIG welding.
- Postflow is available - the same postflow time will be used in MIG and TIG.
- When machine output on/off is controlled via the upper right knob, gas flow will not start until the tungsten touches the work. Gas flow will continue when the arc is broken until the Postflow time expires.
- When machine output on/off is controlled via an arc start switch or foot Amptrol, gas will begin flowing when the output is turned on and will continue flowing until the output is turned off and the Postflow time expires.

P.9 Crater Delay

Use the crater delay to skip the Crater sequence when making short tack welds. If the trigger is released before the Crater Delay Timer ends, then the Crater sequence is skipped. If the trigger is released afterwards, the

Crater sequence functions normally.

- Values = OFF to 10.0 seconds (OFF is default).

P.14 Reset Consumable Weight

This parameter only appears with systems using Production Monitoring. Use this parameter to reset the initial weight of the consumable package.

P.16 Push-Pull Gun Knob

- Gun Pot Enabled = The wire feed speed is always controlled by the potentiometer on the push-pull gun (default).
- Gun Pot Disabled = The wire feed speed is always controlled by the left display knob on the feeder.
- Gun Pot Proc A = When in procedure A, the wire feed speed is set by the push-pull gun potentiometer. When in procedure B, the wire feed speed is set by the left display knob on the feeder.

P.17 Remote Control

Selects the type of analog remote control being used. Digital remote control devices (those with a digital display) are configured automatically. On machines that do not have a 12-pin connector, the "joystick" settings will not appear.

- "All Mode Remote" - This setting allows the remote control to function in all weld modes which is how most machines with 6-pin and 7-pin remote control connections operate. This setting was provided so that customers with a mix of Lincoln Electric equipment can have consistent remote control behavior across all of their equipment.
- "PushPull Gun" - Use this setting while MIG welding with a push-pull gun that uses a potentiometer for wire feed speed control. Stick, TIG and gouge welding currents are set at the User Interface. This setting is backward compatible with the "PushPull" settings of P.17 "Gun Selection".
- "TIG Amp Control" - Use this setting while TIG welding with a foot or hand current control device (Amptrol). While TIG welding, the upper left knob on the User Interface sets the maximum current obtained when the TIG amp control is at its maximum setting. MIG wire feed speed and stick/gouge welding currents are set at the User Interface.
- "Stick/Gouge Rem." - Use this setting while stick welding or gouging with a remote output control device. While stick welding, the upper left knob on the User Interface sets the maximum current obtained when the stick remote is at its maximum setting. While gouging, the upper left knob is disabled and the gouging current is set on the remote control. MIG wire feed speed and TIG welding current are set at the User Interface.
- "Joystick MIG gun" (default) - Use this setting while MIG welding with a push MIG gun with a joystick control. Stick, TIG and gouge welding currents are set at the User Interface.

P.20 Display Trim as Volts Option

Determines how trim is displayed.

- False = The trim is displayed in the format defined in the weld set (default).
- True = All trim values are displayed as a voltage.

P.22 Arc Start/Loss Error Time

Can be used to optionally shut off output if an arc is not established, or is lost for a specified amount of time.

Error 269 will be displayed if the machine times out. If the value is set to OFF, machine output will not be turned off if an arc is not established nor will output be turned off if an arc is lost. The trigger can be used to hot feed the wire (default). If a value is set, the machine output will shut off if an arc is not established within the specified amount of time after the trigger is pulled or if the trigger remains pulled after an arc is lost. This is disabled while welding in Stick, TIG or Gouge. To prevent nuisance errors, set Arc Start/Loss Error Time to an appropriate value after considering all welding parameters (run-in wire feed speed, weld wire feed speed, electrical stick out, etc). To prevent subsequent changes to Arc Start/Loss Error Time, the setup menu should be locked out by setting Preference Lock = Yes using the Power Wave Manager software.

P.25 Joystick Configuration

The new analog and digital gun controls have a joystick to allow the user to change various weld settings at the gun rather than having to go to the user interface. P.25 can be used to change the behaviour of the joystick. In all configurations, the up and down joystick positions will adjust the wire feed speed, while welding and while not welding. P.25 is used to reconfigure the behaviour of the left and right joystick positions.

- When P.25 is set to "Trim/Volts/etc.", the left and right joystick positions will adjust Arc Length Trim, Arc Voltage, Power or STT Background Current based on the selected weld mode. For example, when a non-synergic STT weld mode is selected, the left and right joystick positions will adjust Background Current. When a Power mode is selected, the left and right joystick positions will adjust the Power (kW).
- When P.25 is set to "Memory+Trim/etc.", the left and right joystick positions will select a user memory while not welding and adjust Trim/Voltage/Power/STT Background Current while welding.
- When P.25 is set to "Procedure A/B", the left and right joystick positions will be used to select procedure A and B, while welding and while not welding. The left joystick position selects procedure A, the right joystick position selects procedure B.

P.26 Show Memory LED?

On user interfaces that support user memories but do not have dedicated user memory buttons, this parameter is used to show or hide the LED that is used to select a user memory to save to or recall from. When P.26 is set to Yes, the user memory LED will be shown and the operator can save to and recall from user memories. When P.26 is set to No, the user memory LED will not be shown, preventing the operator from saving to and recalling from user memories.

Diagnostic Parameters

P.80 Sense from Studs

Use this parameter for diagnostic purposes only. When power is cycled, P.80 is automatically reset to False.

- False = Sensing for the electrode (67) and work (21) is determined by the DIP switches of the system.
- True = Sensing for the electrode (67) and work (21) is measured at the studs of the power source and the DIP switch settings are overridden.

P.82. Voltage Sense Display

Allows viewing of Voltage Sense Lead Selection to aid in troubleshooting. The configuration is displayed as a text string on the MSP display whenever the output is enabled. This parameter is not saved on a power cycle, but will be reset to False.

P.99 Show Test Modes

Many weld tables include special modes for testing and servicing the welding system. Set this parameter to YES to show all test modes. When the power source is turned off, the Show Test Modes parameter automatically reverts back to "NO".

P.100 View Diagnostics

Diagnostics are only used for servicing the Power Wave system.

- Yes = Shows P.101 through P.500 in the SETUP menu.
- No = Only P.0 through P.100 are shown in the SETUP menu.

P.101 Event Logs

Press the right MSP4 button to view the Event Logs. Rotate the encoder to select the object to read and then press the right MSP4 button. Various software information will appear about key system events. Press the left MSP4 button to exit.

P.102 Fatal Logs

Press the right MSP4 button to view the Fatal Logs. Rotate the encoder to select the module to read and then press the right MSP4 button. Various software information will appear about critical module actions. Press the left MSP4 button to exit.

P.103 Software Version

Press the right MSP4 button to view the software loaded into each module (p.c. board). Rotate the encoder to select the module to read and then press the right MSP4 button. The panel will display the main software version loaded into the module. Press the left MSP4 button to exit.

P.104 View Hardware Version Information

Used for viewing the hardware version for each board in the system. Press the right MSP Button to enter the option. Rotate Set knob to select the desired board to read. Press the right button again to read the hardware version. Press the left button to back out to select another board. Press the left button again to exit this option.

P.105 View Welding Software Information

Used for viewing the Weld Set in the Power Source. Press the right MSP Button to read the Weld Set version. Press the left button to back out and exit this option.

P.106 View Ethernet IP Address

Used for viewing the Ethernet Network IP address if there is an Ethernet board present in the system. Press the right MSP Button to read the IP Address. Press the left button to back out and exit this option. The IP address cannot be changed using this option.

P.107 View Power Source Protocol

Used for viewing the type of power source the feeder is connected to. Press the right MSP Button to identify the

power source as either LincNet or ArcLink. Press the left button to back out and exit this option.

Secured Parameters accessible through Power Wave Manager only

P.500 View Lockout Parameters

Originally used to prevent inadvertent changes of secure setup parameters, P.500 was previously used as a gateway to these parameters. Presently, this option does not exist in any setup menu.

P.501 Encoder Lockout

Locks one or both of the upper knobs (encoders), preventing the operator from changing wire feed speed, amps, volts or trim. The function of each upper knob depends on the selected weld mode. When a constant current weld mode is selected (e.g. Stick, TIG, Gouge), the upper right knob will always function as an on/off switch. This parameter can only be accessed using Weld Manager or Power Wave Manager software.

P.502 Memory Change Lockout

Determines if the memories can be overwritten with new contents.

- No = Memories can be saved and limits can be configured (default).
- Yes = Memories cannot be changed - saving is prohibited and limits cannot be re-configured.

This parameter can only be accessed using Power Wave Manager.

P.503 Memory Button Disable

Disables the specified memory button(s). When a memory is disabled, welding procedures cannot be restored from or saved to that memory. If an attempt is made to save or restore a disabled memory, a message will be displayed on the Mode Select Panel indicating the memory number is disabled. In multi-head systems, this parameter disables the same memory buttons on both feed heads. This parameter can only be accessed using Weld Manager or Power Wave Manager software.

P.504 Mode Select Panel Lock

Selects between several Mode Select Panel lockout preferences. When a Mode Select Panel selection is locked and an attempt is made to change that parameter, a message will be displayed on the Mode Select Panel indicating the parameter is locked.

- All MSP Options Unlocked = All adjustable parameters on the Mode Select Panel are unlocked.
- All MSP Options Locked = All knobs and buttons on the Mode Select Panel are locked.
- Start & End Options Locked = The Start and End parameters on the Mode Select Panel are locked, all others are unlocked.
- Weld Mode Option Locked = The weld mode cannot be changed from the Mode Select Panel, all others Mode Select Panel settings are unlocked.
- Wave Control Options Locked = The Wave Control parameters on the Mode Select Panel are locked, all others are unlocked.
- Start, End, Wave Options Locked = The Start, End and Wave Control parameters on the Mode Select Panel are locked, all others are unlocked.
- Start, End, Mode Options Locked = The Start, End and Weld Mode Select parameters on the Mode Select Panel are locked, all others are unlocked.

This parameter can only be accessed using Power Wave Manager.

P.505 Setup Menu Lock

Determines if the setup parameters can be modified by the operator without entering a passcode.

- No = The operator can change any set menu parameter without first entering the passcode even if the passcode is non-zero (default).
- Yes = The operator must enter the passcode (if the passcode is non-zero) in order to change any setup menu parameters.

This parameter can only be accessed using Power Wave Manager.

P.506 Set User Interface Passcode

Prevents unauthorized changes to the equipment. The default passcode is zero which allows full access. A nonzero passcode will prevent unauthorized:

- changes to memory limits
- saving to memory (if P.502 = Yes)
- changes to setup parameters (if P.505 = Yes)

This parameter can only be accessed using Power Wave Manager.

P.509 UI Master Lockout

Locks all user interface controls, preventing the operator from making any changes.

This parameter can only be accessed using Power Wave Manager.

Electromagnetic Compatibility (EMC)

01/11

This machine has been designed in accordance with all relevant directives and standards. However, it may still generate electromagnetic disturbances that can affect other systems like telecommunications (telephone, radio, and television) or other safety systems. These disturbances can cause safety problems in the affected systems. Read and understand this section to eliminate or reduce the amount of electromagnetic disturbance generated by this machine.



This machine has been designed to operate in an industrial area. The operator must install and operate this equipment as described in this manual. If any electromagnetic disturbances are detected the operator must put in place corrective actions to eliminate these disturbances with, if necessary, assistance from Lincoln Electric. This equipment does not comply with IEC 61000-3-12. If it is connected to a public low-voltage system, it is responsibility of the installer or user of the equipment to ensure, by consultation with the distribution network operator if necessary, that the equipment may be connected.

Before installing the machine, the operator must check the work area for any devices that may malfunction because of electromagnetic disturbances. Consider the following.

- Input and output cables, control cables, and telephone cables that are in or adjacent to the work area and the machine.
- Radio and/or television transmitters and receivers. Computers or computer controlled equipment.
- Safety and control equipment for industrial processes. Equipment for calibration and measurement.
- Personal medical devices like pacemakers and hearing aids.
- Check the electromagnetic immunity for equipment operating in or near the work area. The operator must be sure that all equipment in the area is compatible. This may require additional protection measures.
- The dimensions of the work area to consider will depend on the construction of the area and other activities that are taking place.

Consider the following guidelines to reduce electromagnetic emissions from the machine.

- Connect the machine to the input supply according to this manual. If disturbances occur it may be necessary to take additional precautions such as filtering the input supply.
- The output cables should be kept as short as possible and should be positioned together. If possible connect the work piece to ground in order to reduce the electromagnetic emissions. The operator must check that connecting the work piece to ground does not cause problems or unsafe operating conditions for personnel and equipment.
- Shielding of cables in the work area can reduce electromagnetic emissions. This may be necessary for special applications.

WARNING

The Class A equipment is not intended for use in residential locations where the electrical power is provided by the public low-voltage supply system. There can be potential difficulties in ensuring electromagnetic compatibility in those locations, due to conducted as well as radio-frequency disturbances.



Technical Specifications

POWER WAVE® C300CE

POWER SOURCE – INPUT VOLTAGE AND CURRENT					
Model	Duty Cycle	Input Voltage ± 10%	Input Amperes	Idle Power	Power Factor @ Rated Input
K2865-1	40% rating	208/230/400*/460/575 3 phase 50/60 Hz (* includes 380V to 415V)	30/28/16/14/11	300 W Max. (fan on)	0,95
	60% rating		23/21/12/11/9		
RATED OUTPUT					
Process	Duty Cycle (%)	Volts (RMS) @ Rated Amperes (V)		Amperes (RMS) (A)	
GMAW GMAW-Pulse FCAW	40	29		300	
	100	26,5		250	
SMAW	40	31,2		280	
	100	29		225	
GTAW-DC	40	22		300	
	100	20		250	
RECOMMENDED INPUT WIRE AND FUSES SIZES ¹					
Input Voltage/ Phase/Frequency	Input Ampere Rating on Nameplate	Type 75°C Cored Sizes in Conduit AWG Sizes (mm ²)	Type 75°C Ground Wire in Conduit AWG Sizes (mm ²)	(Super Lag) or Breaker Sizes ² (A)	
208/3/50/60	30	8 (10)	10 (6)	40	
230/3/50/60	28	8 (10)	10 (6)	40	
400/3/50/60	16	12 (4)	10 (6)	25	
460/3/50/60	14	14 (2,5)	10 (6)	20	
575/3/50/60	11	14 (2,5)	10 (6)	15	

¹ Cord and Fuse Sizes based upon the U.S. National Electric Code and maximum output for 40°C (104°) ambient.

² Also called "inverse time" or "thermal/magnetic" circuit breakers; circuit breakers that have a delay in tripping action that decreases as the magnitude of current increases.

WIRE FEED SPEED RANGE - WIRE SIZES				
WFS Range (m/min)	GMAW Mild Steel	GMAW Aluminum	GMAW Stainless	FCAW
	Wire Sizes (mm)	Wire Sizes (mm)	Wire Sizes (mm)	Wire Sizes (mm)
1,3 – 17,8	0,6 – 1,2	0,8 – 1,6	0,8 – 1,2	0,9 – 1,2
WELDING PROCESS				
Process	Output Range (A)		OCV (U ₀) (V)	
GMAW	5 - 300		70	
GMAW-Pulse			70	
FCAW			70	
GTAW-DC			70	
SMAW			70	
PHYSICAL DIMENSIONS				
Model	Height (mm)	Width (mm)	Depth (mm)	Weight (kg)*
K2865-1	477,5	356	610	50,4
TEMPERATURE RANGES				
Operating Temperature Range (°C)		Storage Temperature Range (°C)		
-20 to +40		-40 to +85		

IP23 155°F) Insulation Class

* Weight does not include input cord.

WEEE

English		Do not dispose of electrical equipment together with normal waste!
		In observance of European Directive 2012/19/EC on Waste Electrical and Electronic Equipment (WEEE) and its implementation in accordance with national law, electrical equipment that has reached the end of its life must be collected separately and returned to an environmentally compatible recycling facility. As the owner of the equipment, you should get information on approved collection systems from our local representative. By applying this European Directive you will protect the environment and human health!

07/06

Spare Parts

12/05

Part List reading instructions

- Do not use this part list for a machine if its code number is not listed. Contact the Lincoln Electric Service Department for any code number not listed.
- Use the illustration of assembly page and the table below to determine where the part is located for your particular code machine.
- Use only the parts marked "X" in the column under the heading number called for in the assembly page (# indicate a change in this printing).

First, read the Part List reading instructions above, then refer to the "Spare Part" manual supplied with the machine, that contains a picture-descriptive part number cross-reference.

Electrical Schematic

Refer to the "Spare Part" manual supplied with the machine.

Accessories

Item number	Description
K14087-1	POWER WAVE CART C300
K14050-1	Coolarc-50
K10420-1	COOLANT ACOROX (2X5L)
K10413-360GC-4M	LG360GC 4meter with cross switch
K10413-505WC-4M	LG505WC 4meter with cross switch
K10514-P-8	Push Pull gun Panther CE 8 meter
K10514-C-8	Push Pull gun Cougar CE 8 meter
K10095-1-15M	Remote control 6-pins, 15m
K870	FOOT AMPTRON
K2909-1	6-Pin(F) to 12-Pin(M) CE Adapter for Remote Applications - 0,5m
See Linc Torch brochure	TIG Options
See Linc Gun brochure	MIG Standard Options

Drive rolls set includes: 2 rolls and inner wire guide

KP1696-030S	Drive rolls for Steel Wire V0.6-0.8mm
KP1696-2	Drive rolls for Steel Wire V1.0mm
KP1696-1	Drive rolls for Steel Wire V0.9-1.2mm
KP1697-035C	Drive rolls for Cored Wires Knurled 0.8-0.9mm
KP1697-045C	Drive rolls for Cored Wires Knurled 1.0-1.2mm

Drive rolls set includes: 2 rolls and inner and outer wire guide

KP1695-035A	Drive rolls for Aluminium Wire U0.9mm
KP1695-040A	Drive rolls for Aluminium Wire U1,0mm
KP1695-3/64A	Drive rolls for Aluminium Wire U1,2mm
KP1695-1/16A	Drive rolls for Aluminium Wire U1,6mm

Optional items if ordered separately

KP2178-1	Inner Wire Guides for Steel and Cored Wire 0.6-0.8-0.9mm
KP2178-2	Inner Wire Guides for Cored Wires 1.0-1.2mm
KP2178-6	Inner Wire Guides for Steel Wire 0.9-1,0-1.2mm
KP2071-3	Outer Wire Guides for Steel and Cored Wire 0.6-0.8-0,9-1,0-1,2mm
KP2071-4	Outer Wire Guides for Aluminium Wire 0,9-1,2mm
KP2173-1	Inner Wire Guides for Aluminium Wire 0,9mm
KP2173-2	Inner Wire Guides for Aluminium Wire 1,2mm