



Rogue ET 230iP AC/DC power source



Instruction manual



EU DECLARATION OF CONFORMITY

According to:

The Low Voltage Directive 2014/35/EU;
The RoHS Directive 2011/65/EU;

The EMC Directive 2014/30/EU;
The Ecodesign Directive 2009/125/EC

Type of equipment

Arc welding power source

Type designation

Rogue ET230iP AC/DC from serial number HA336 YY XX XXXX
X and Y represents digits, 0 to 9 in the serial number, where YY indicates year of production.

Brand name or trademark

ESAB

Manufacturer or his authorised representative established within the EEA

ESAB AB
Lindholmsallén 9, Box 8004, SE-402 77 Göteborg, Sweden
Phone: +46 31 50 90 00, www.esab.com

The following EN standards and regulations in force within the EEA has been used in the design:

EN IEC 60974-1:2022+A11:2022	Arc Welding Equipment - Part 1: Welding power sources
EN IEC 60974-3:2019	Arc Welding Equipment - Part 3: Arc striking and stabilizing devices
EU reg. no. 2019/1784	Ecodesign requirements for welding equipment pursuant to Directive 2009/125/EC
EN IEC 60974-10:2021	Arc Welding Equipment - Part 10: Electromagnetic compatibility (EMC) requirements

Additional Information:

Restrictive use, Class A equipment, intended for use in locations other than residential.

By signing this document, the undersigned declares as manufacturer, or the manufacturer's authorised representative established within the EEA, that the equipment in question complies with the safety and environmental requirements stated above.

Place/Date

Signature

Gothenburg
2024-01-23

Peter Burchfield
General Manager, Equipment Solutions



TABLE OF CONTENTS

1	SAFETY	4
1.1	Meaning of symbols	4
1.2	Safety precautions	4
2	INTRODUCTION	7
2.1	Equipment	7
3	TECHNICAL DATA	8
3.1	ECO design information	10
4	INSTALLATION	11
4.1	Location	11
4.2	Lifting instructions	11
4.3	Mains supply	12
4.4	Recommended fuse sizes and minimum cable area	12
4.5	Connecting the power source and cooling unit	13
5	OPERATION	16
5.1	Connections and control devices	16
5.2	Connecting welding and return cables	16
5.3	Turning the mains power on/off	17
5.4	Fan control	17
5.5	Thermal protection	17
5.6	Voltage reduction device (VRD)	17
5.7	User interface	18
	5.7.1 Control panel	18
	5.7.2 Information screen	18
	5.7.3 Settings screen	18
	5.7.4 Remote screen	20
	5.7.5 Jobs screen	21
	5.7.6 Welding screen	22
	5.7.7 MMA welding	22
	5.7.8 TIG welding	24
6	MAINTENANCE	36
6.1	Routine maintenance	36
6.2	Cleaning instructions	36
7	TROUBLESHOOTING	39
8	ERROR CODES	41
8.1	Error code descriptions	41
9	ORDERING SPARE PARTS	42
	BLOCK DIAGRAM	43
	ORDERING NUMBERS	44
	ACCESSORIES	45

1 SAFETY

1.1 Meaning of symbols

As used throughout this manual: Means Attention! Be Alert!

**DANGER!**

Means immediate hazards which, if not avoided, will result in immediate, serious personal injury or loss of life.

**WARNING!**

Means potential hazards which could result in personal injury or loss of life.

**CAUTION!**

Means hazards which could result in minor personal injury.

**WARNING!**

Before use, read and understand the instruction manual and follow all labels, employer's safety practices and Safety Data Sheets (SDSs).



1.2 Safety precautions

Users of ESAB equipment have the ultimate responsibility for ensuring that anyone who works on or near the equipment observes all the relevant safety precautions. Safety precautions must meet the requirements that apply to this type of equipment. The following recommendations should be observed in addition to the standard regulations that apply to the workplace.

All work must be carried out by trained personnel well-acquainted with the operation of the equipment. Incorrect operation of the equipment may lead to hazardous situations which can result in injury to the operator and damage to the equipment.

1. Anyone who uses the equipment must be familiar with:
 - its operation
 - location of emergency stops
 - its function
 - relevant safety precautions
 - welding and cutting or other applicable operation of the equipment
2. The operator must ensure that:
 - no unauthorised person is stationed within the working area of the equipment when it is started up
 - no-one is unprotected when the arc is struck or work is started with the equipment
3. The workplace must:
 - be suitable for the purpose
 - be free from drafts
4. Personal safety equipment:
 - Always wear recommended personal safety equipment, such as safety glasses, flame-proof clothing, safety gloves
 - Do not wear loose-fitting items, such as scarves, bracelets, rings, etc., which could become trapped or cause burns

5. General precautions:

- Make sure the return cable is connected securely
- Work on high voltage equipment **may only be carried out by a qualified electrician**
- Appropriate fire extinguishing equipment must be clearly marked and close at hand
- Lubrication and maintenance must **not** be carried out on the equipment during operation

If equipped with ESAB cooler

Use ESAB approved coolant only. Non-approved coolant might damage the equipment and jeopardize product safety. In case of such damage, all warranty undertakings from ESAB cease to apply.

For ordering information, see the "ACCESSORIES" chapter in the instruction manual.



WARNING!

Arc welding and cutting can be injurious to yourself and others. Take precautions when welding and cutting.



ELECTRIC SHOCK - Can kill

- Install and ground the unit in accordance with instruction manual.
- Do not touch live electrical parts or electrodes with bare skin, wet gloves or wet clothing.
- Insulate yourself from work and ground.
- Ensure your working position is safe



ELECTRIC AND MAGNETIC FIELDS - Can be dangerous to health

- Welders having pacemakers should consult their physician before welding. EMF may interfere with some pacemakers.
- Exposure to EMF may have other health effects which are unknown.
- Welders should use the following procedures to minimize exposure to EMF:
 - Route the electrode and work cables together on the same side of your body. Secure them with tape when possible. Do not place your body between the torch and work cables. Never coil the torch or work cable around your body. Keep welding power source and cables as far away from your body as possible.
 - Connect the work cable to the workpiece as close as possible to the area being welded.



FUMES AND GASES - Can be dangerous to health

- Keep your head out of the fumes.
- Use ventilation, extraction at the arc, or both, to take fumes and gases away from your breathing zone and the general area.



ARC RAYS - Can injure eyes and burn skin

- Protect your eyes and body. Use the correct welding screen and filter lens and wear protective clothing.
- Protect bystanders with suitable screens or curtains.



NOISE - Excessive noise can damage hearing

Protect your ears. Use earmuffs or other hearing protection.

MOVING PARTS - Can cause injuries



- Keep all doors, panels and covers closed and securely in place. Have only qualified people remove covers for maintenance and troubleshooting as necessary. Reinstall panels or covers and close doors when service is finished and before starting engine.



- Stop engine before installing or connecting unit.
- Keep hands, hair, loose clothing and tools away from moving parts.

FIRE HAZARD



- Sparks (spatter) can cause fire. Make sure that there are no inflammable materials nearby.
- Do not use on closed containers.

HOT SURFACE - Parts can burn



- Do not touch parts bare handed.
- Allow cooling period before working on equipment.
- To handle hot parts, use proper tools and/or insulated welding gloves to prevent burns.

MALFUNCTION - Call for expert assistance in the event of malfunction.

PROTECT YOURSELF AND OTHERS!



CAUTION!

This product is solely intended for arc welding.



WARNING!

Do not use the power source for thawing frozen pipes.



CAUTION!

Class A equipment is not intended for use in residential locations where the electrical power is provided by the public low-voltage supply system. There may be potential difficulties in ensuring electromagnetic compatibility of class A equipment in those locations, due to conducted as well as radiated disturbances.

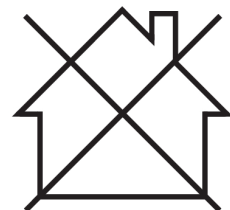

NOTE!

Dispose of electronic equipment at the recycling facility!

In observance of European Directive 2012/19/EC on Waste Electrical and Electronic Equipment and its implementation in accordance with national law, electrical and/or electronic equipment that has reached the end of its life must be disposed of at a recycling facility.

As the person responsible for the equipment, it is your responsibility to obtain information on approved collection stations.

For further information contact the nearest ESAB dealer.

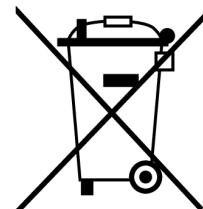

ESAB has an assortment of welding accessories and personal protection equipment for purchase. For ordering information contact your local ESAB dealer or visit us on our website.

2 INTRODUCTION

The **Rogue ET 230iP AC/DC power source** offers a multi-process package supporting DC TIG, AC TIG, and MMA.

ESAB accessories for the product can be found in the "ACCESSORIES" chapter of this manual.

2.1 Equipment

The package includes:

- Power source
- 3 mts, 3 x 2.5 mm² input cable (Schuko plug 16 A)
- Ground clamp, 3 m, 25 mm² lead
- Gas hose, 4 m (quick connector, none)
- Quick start guide
- Safety manual

3 TECHNICAL DATA

Rogue ET 230iP AC/DC		
Mains voltage	1Ø 120V, 50/60 Hz	1Ø 230V, 50/60 Hz
Primary current I_{max}		
MMA	22.4 A	27A
TIG	22 A	25.5 A
Idle state power (fan stop running)		
	40W (VRD OFF) 20W (VRD ON)	40W (VRD OFF) 20W (VRD ON)
Setting range		
MMA	10 A / 20.4 V - 90 A / 23.6 V	10 A / 20.4 V - 180 A / 27.2 V
TIG (AC)	15 A / 10.6 V - 125 A / 15 V	15 A / 10.6 V - 230 A / 19.2 V
TIG (DC)	5 A / 10.2 V - 125 A / 15 V	5 A / 10.2 V - 230 A / 19.2 V
Permissible load at MMA		
30% duty cycle	90 A / 23.6 V	180 A / 27.2 V
60% duty cycle	64 A / 22.5 V	127 A / 25 V
100% duty cycle	49.3 A / 22 V	99 A / 23.9 V
Permissible load at TIG		
30% duty cycle	125 A / 15 V	230 A / 19.2 V
60% duty cycle	88.4 A / 13.5 V	163 A / 16.5 V
100% duty cycle	68.5 A / 12.7 V	126 A / 15 V
Apparent power I₂ at maximum current	2.56 KW	5.79 KW
Active power I₂ at maximum current	2.10 KW	4.80 KW
Power factor at maximum current		
MMA	0.99	0.99
TIG	0.99	0.99
Efficiency at maximum current		
MMA	82%	83%
Open-circuit voltage U₀ max		
VRD deactivated	68 V	68 V
VRD activated (standard setting at delivery)	10 V	10 V
Operating temperature	-10 to +40 °C (+14 to +104 °F)	
Transportation temperature	-20 to +55 °C (-4 to +131 °F)	
Constant sound pressure when idling	<70 db (A)	
Dimensions l × w × h	460 × 210 × 380 mm	
Weight	19 kg (41.9 lbs)	

Rogue ET 230iP AC/DC	
Insulation class	F
Enclosure class	IP 23S
Application class	S

Mains supply, $S_{sc\ min}$

Minimum short circuit power on the network in accordance with IEC 61000-3-12.

Duty cycle

The duty cycle refers to the time as a percentage of a ten-minute period that you can weld or cut at a certain load without overloading. The duty cycle is valid for 40 °C / 104 °F, or below.

Enclosure class

The **IP** code indicates the enclosure class, i.e. the degree of protection against penetration by solid objects or water.

Equipment marked **IP23S** is intended for indoor and may be used outdoors if sheltered during precipitation.

Application class

The symbol **S** indicates that the power source is designed for use in areas with increased electrical hazard.

3.1 ECO design information

The equipment has been designed in order to be compliant with the Directive 2009/125/EC and the Regulation 2019/1784/EU.

Efficiency and idle power consumption:

Name	Idle power	Efficiency when max power consumption
Rogue ET 230iP ACDC	20 W	83%

The value of efficiency and consumption in idle state have been measured by method and conditions defined in the product standard EN 60974-1:2012.

Manufacturer's name, product name, serial number and date of production can be read from rating plate.

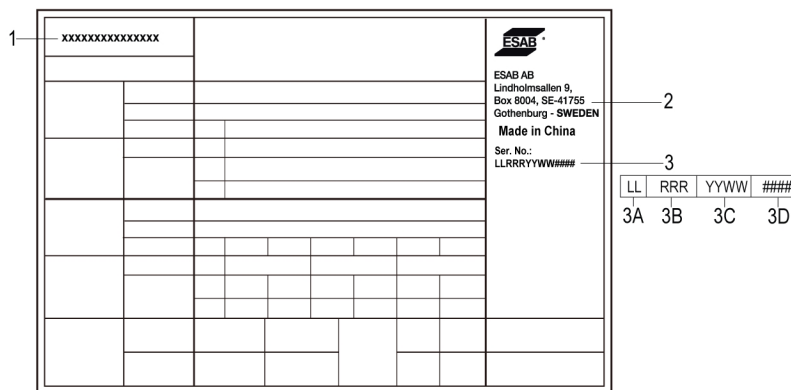

- 1. Product name
- 2. Manufacturer's name and address
- 3. Serial number
 - 3A. Manufacturing location code
 - 3B. Revision level (last digit of year and week number)
 - 3C. Year & week produced (last two digits of year and week number)
 - 3D. Sequential number system (each week starts with 0001)

4 INSTALLATION

The installation must be carried out by a professional.



CAUTION!

This product is intended for industrial use. In a domestic environment this product may cause radio interference. It is the user's responsibility to take adequate precautions.

4.1 Location

Position the power source so that cooling air inlets and outlets are not obstructed.

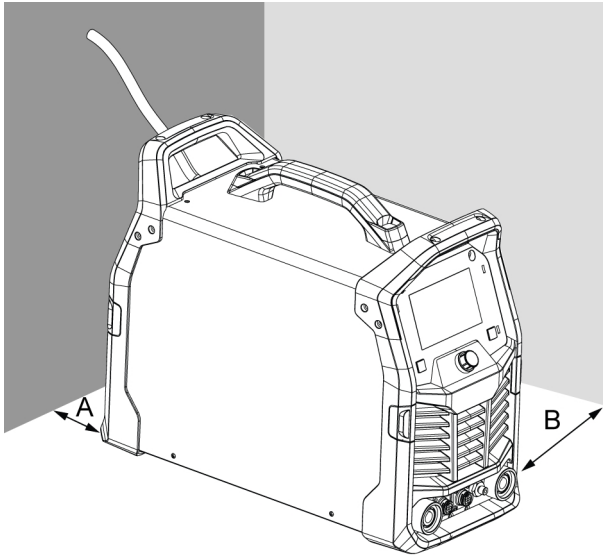

A. Minimum 200 mm (8 in.)

B. Minimum 200 mm (8 in.)

4.2 Lifting instructions

The power source can be lifted using any of the handles.

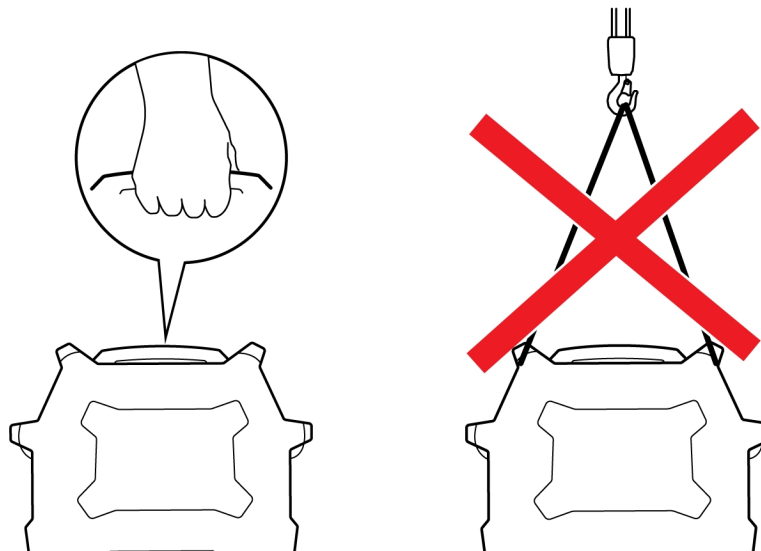



WARNING!

Secure the equipment - particularly if the ground is uneven or sloping.

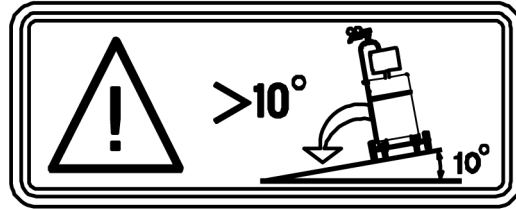

4.3 Mains supply



NOTE!

Mains supply requirements

This equipment complies with IEC 61000-3-12 provided that the short-circuit power is greater than or equal to S_{scmin} at the interface point between the user's supply and the public system. It is the responsibility of the installer or user of the equipment to ensure, by consultation with the distribution network operator if necessary, that the equipment is connected only to a supply with a short-circuit power greater than or equal to S_{scmin} . Refer to the technical data in the TECHNICAL DATA chapter.

1. Rating plate with supply connection data in the bottom of machine

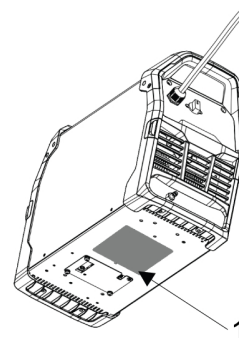

4.4 Recommended fuse sizes and minimum cable area



WARNING!

An electrical shock or fire hazard is probable if the following electrical service guide recommendations are not followed. These recommendations are for a dedicated branch circuit sized for the rated output and duty cycle of the welding power source.

	120/230V, 1 ~ 50/60Hz	
	230 V AC	120 V AC
Supply voltage	230 V AC	120 V AC
Input current at maximum output	27 A	22.4 A
Maximum recommended fuse* or circuit breaker rating *Time delay fuse		
Maximum recommended fuse or circuit breaker rating	16 A	40 A
Minimum recommended cord size	2.5 mm ² (13 AWG)	2.5 mm ² (13 AWG)

	120/230V, 1 ~ 50/60Hz	
Maximum recommended extension cord length	15m (50 ft)	15m (50 ft)
Minimum recommended grounding conductor size	2.5 mm ² (13 AWG)	2.5 mm ² (13 AWG)

Supply from power generators

The power source can be supplied from different types of generators. However, some generators may not provide sufficient power for the welding power source to operate correctly. Generators with Automatic Voltage Regulation (AVR) or with equivalent or better type of regulation, with rated power 13 kW, are recommended.

4.5 Connecting the power source and cooling unit

Only those persons who have appropriate electrical knowledge (authorized personnel) may remove the safety plates to connect or carry out service, maintenance or repair work on welding equipment.

- 1) Power off the welding power source.
- 2) Install attachment on the bottom plate of power source.

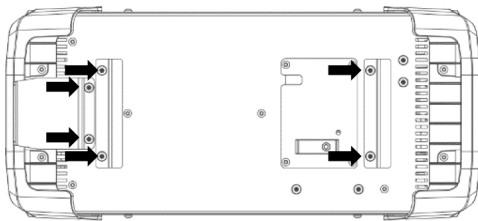

- 3) Remove the four screws on the bottom plate of power source, and remove the small square shape sheet material.

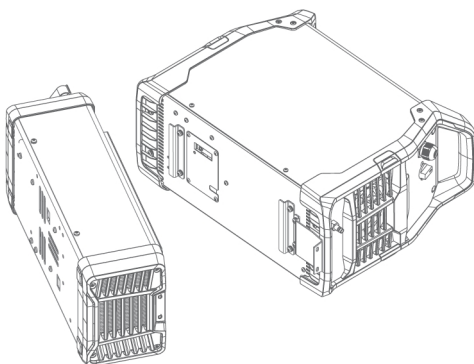

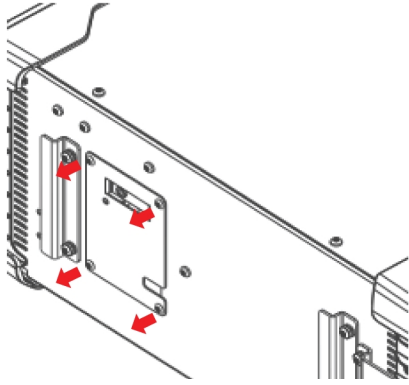

4) Connect the power cable and interconnection lead.

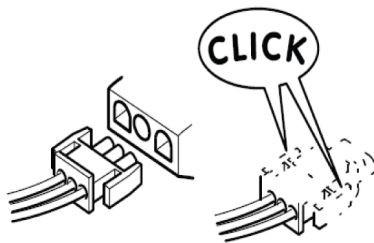
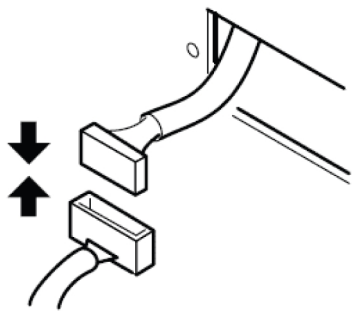

5) Put the square shape sheet material back and fix with screws to bottom plate of power source.

6) Put the power source on the top of cooler and push the power source from back of cooler.

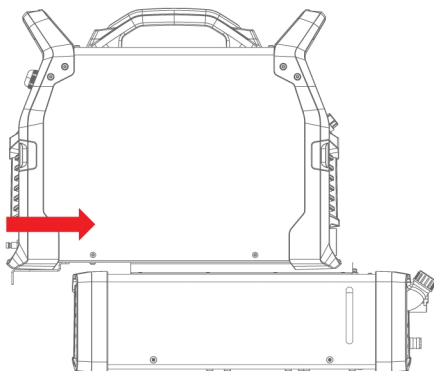

4 INSTALLATION

7) Use screws to fix the power source with cooler at the rear panel of cooler.

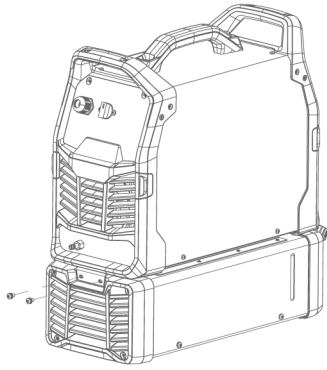

NOTE!

Coolant must be topped up if connecting a welding torch or connection cables that are four meters in length or longer.

5 OPERATION

General safety regulations for handling the equipment can be found in the "SAFETY" chapter of this manual. Read it through before you start using the equipment!



NOTE!

When moving the equipment use intended handle. Never pull the cables.



WARNING!

Electric shock! Do not touch the workpiece or the welding head during operation!

5.1 Connections and control devices

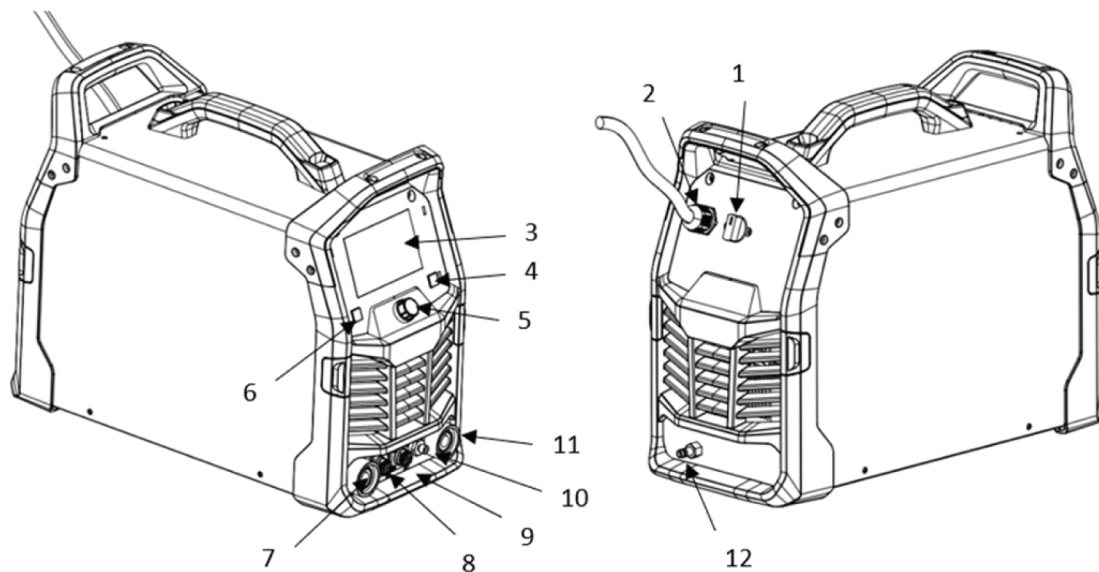

- | | |
|----------------------|-------------------|
| 1. Power switch | 7. OKC (+) |
| 2. Input cable | 8. 2Pin connector |
| 3. TFT | 9. 8Pin connector |
| 4. Process selection | 10. Gas outlet |
| 5. Knob | 11. OKC (-) |
| 6. Back bottom | 12. Gas inlet |

5.2 Connecting welding and return cables

The power source has two outputs, a positive welding terminal (+) and a negative welding terminal (-), for connecting welding and return cables. The output to which the welding cable is connected depends on the welding method or type of electrode used.

- For TIG welding, the negative welding terminal (-) is used for the welding torch and the positive welding terminal (+) is used for the return cable.

- For MMA welding, the welding cable can be connected to the positive welding terminal (+) or negative welding terminal (-) depending on the type of electrode used. The connecting polarity is stated on the electrode packaging.
- 1) Connect the return cable to the other output on the power source.
 - 2) Secure the return cable's contact clamp to the work piece and ensure that there is good contact between the work piece and the output for the return cable on the power source.

5.3 Turning the mains power on/off



CAUTION!

Do not turn off the power source during welding (with load).

- 1) To turn on the mains power, turn the switch to the "I" position.
- 2) To turn off the mains power, turn the switch to the "O" position.

Regardless the mains supply is interrupted abnormally, or the power source is switched off in the normal manner, the welding data will be stored, so it will be available next time the unit is turned on.

5.4 Fan control

The power source has an automatic thermal control. When turning on the machine, the fan will run for ten seconds and then stop. Once welding start, the fan continues to run for a few minutes after welding has stopped while the power source switches to energy-saving mode. The fan starts again when welding restarts.

5.5 Thermal protection



The power source includes thermal protection against overheating. When temperature is up to 80% limitation, the overheating indicator on the panel will blink; once temperature exceeds the limitation, the welding is stopped and overheating indicator will be lit and an error message shows in the display. The protection is automatically reset when the temperature has been sufficiently reduced.

5.6 Voltage reduction device (VRD)

VRD

The VRD function ensures that the open-circuit voltage does not exceed 15 V when welding is not being carried out. This is indicated by a lit VRD indicator on the TFT Screen. Default setting for VRD is off. VRD switch S1 is on the HMI PCB. It can be turned on by switching it to on position.

5.7 User interface

5.7.1 Control panel

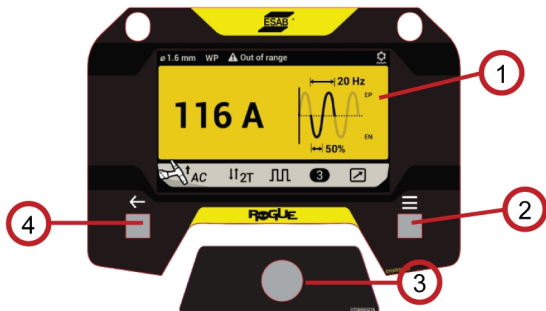

1. Display
2. Process selection button
Press the button to navigate to main menu.
3. Control knob
Turn right/left and press.
4. Back button
Return to previous menu.

5.7.2 Information screen

In this menu, user can find information about wears and spares, tips and hints, recommended filler metals, general maintenance, and user manual QR code.

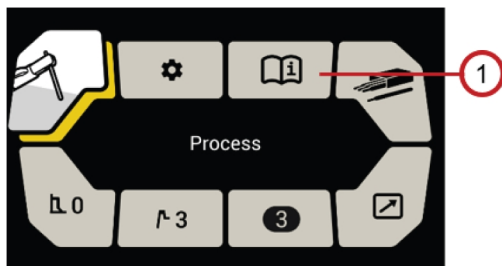

1. Information screen

5.7.3 Settings screen

In this menu, user can change settings. To access the settings, press menu button to enter menu screen, and then turn the main knob to settings icon and press main knob.

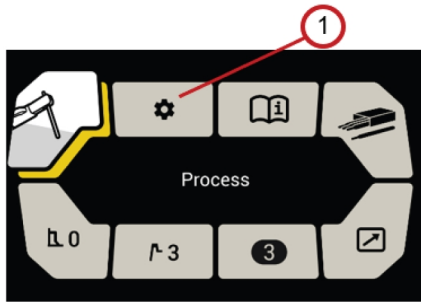

1. Settings screen

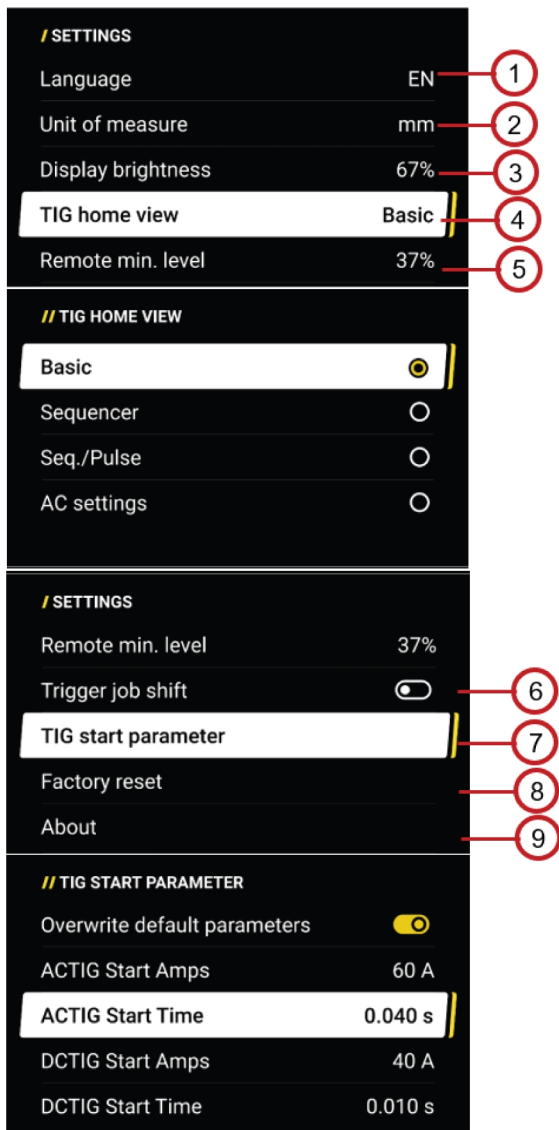

1. Language settings
2. Unit of measure
3. Brightness settings

4. TIG home view

Can be used to select different view of TIG welding in home screen. To enter selection screen, turn main knob and press it when TIG home view is highlighted. Seq/Pulse only can be selected when Pulse is activated.

When AC settings is selected, pressing main knob on home screen will jump to AC setting page directly.

5. Remote min. settings (the percentage of setting amps)

Used to set the minimum current for the foot pedal. It is set in % of the set current in the range from 0–99% in steps of 1%.

For example: If the current is set to 100 A and the remote min current function is set to 20, the remote min current will be 20 A. If the current is set to 80 A and the remote min current function is set to 50, the remote min current will be 40 A.

To enter adjustment screen, press main knob when remote min. level is highlighted and turn main knob to adjustment percentage value as displayed. Confirm settings by pressing main knob and display returns to menu screen.

6. Trigger job shift ON/OFF (Only TIG)

Used to recall stored jobs when machine is on, but arc is not ignited. This function permits changing between different welding data memories by pressing the trigger of the welding torch.

Disabled in MMA process, while in TIG process mode, if MMA parameters are saved in any of first 3 jobs, the trigger job shift will work only for saved TIG jobs.

User can select one of the first three jobs positions and to recall. Trigger needs to be pressed the same number of times as job location. One short press, the TIG torch switches to job 1; two times to job 2, three times to job 3. Jump between 1-2-3-1... (only if the job is not empty). If job >3 is active when "Trigger Job shift" is activated, the job stays active until the user use the trigger to shift to a new job.

User can turn the trigger job shift function on or off, when is lighted, there is indicator in the home screen (see "TIG home screen" chapter) cooler ON/OFF (only TIG).

7. TIG start parameter

Machine has default arc starting parameter when user selects different type/diameter of tungsten. This default setting helps to get good arc starting character. But user can adjust the starting parameters (current and time). Active the "Overwrite parameters" to adjust the arc starting current and time.

8. Factory reset

Reset settings.

9. About

Current software version.

5.7.4 Remote screen



1. Remote screen

Connect the remote control into 8Pin connector in the front side of the power source and activate the remote control on the menu screen. When the remote control is activated, the control panel is locked for interaction but displays welding data.

Should a remote device be connected, the maximum output current of the power source will be determined by the front panel control knob, irrespective of the remote control device setting.

When no remote device is connected to the power source, display shows “No remote detected”. When a remote device (see options in Accessories screen under Information menu) is connected, turn it on or off by turning main knob. Confirm selection by press main knob and display returns to menu screen.

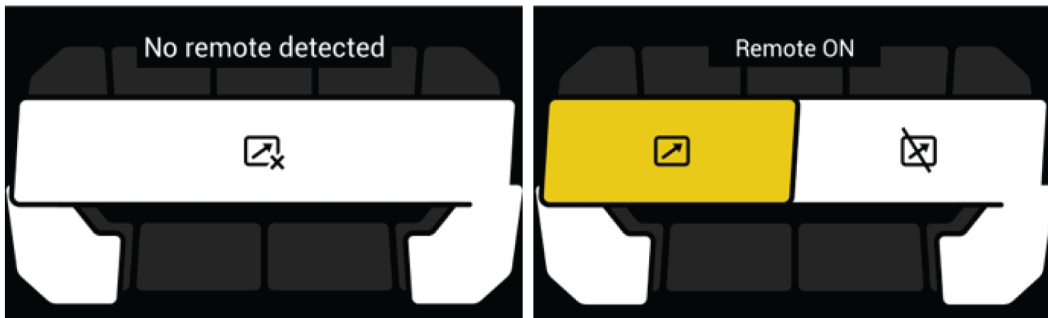

5.7.5 Jobs screen

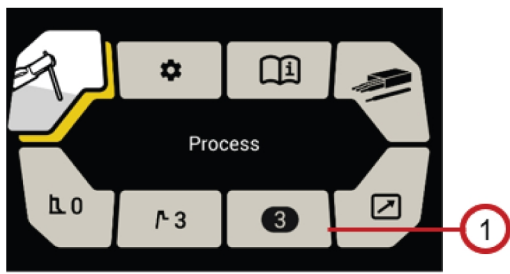

1. Jobs screen

Rogue ET 230iP ACDC power source enables the user to store 10 jobs for each welding process. Critical welding data can be previewed in Jobs menu for easier selection.



To save current welding data, enter Jobs screen to find an available job position or a job position to be replaced, press main knob and hold for two seconds.

To recall a job, enter Jobs screen under corresponding welding process menu screen, scroll through jobs list by rotating main knob, and confirm selection by pressing main knob.

To remove a job, rotate main knob to scroll to the job position, press and hold back button until the screen displays “Clear this Job position”, and confirm by pressing main knob.

5.7.6 Welding screen

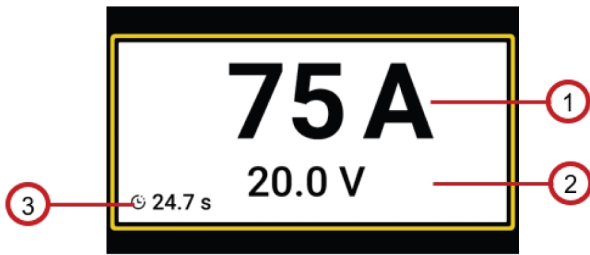

1. Momentary current value during welding, or average current of last weld after welding.
2. Momentary voltage value during welding, or average voltage of last weld after welding.
3. Arc-on time of last weld will be displayed after welding.

Parameters of last weld will be displayed for ten seconds after welding. When the ten seconds are ended and there is no interaction with the user interface, display returns to previous view before welding.

5.7.7 MMA welding



MMA welding may also be referred to as welding with covered electrodes. The arc melts the electrode as well as a local part of the workpiece. The coverage, when melting, forms a protective slag and creates a shielding gas to protect the weld pool from atmospheric contamination.

For MMA welding, the welding power source shall be supplemented with:

- welding cable with electrode holder
- return cable with clamp

MMA/Stick home screen

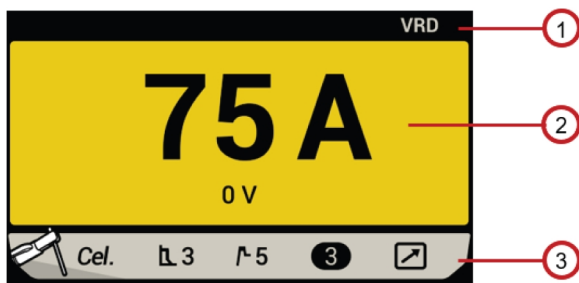

1. VRD
The VRD function ensures that the open-circuit voltage does not exceed 35 V when welding is not being carried out. When VRD is on, "VRD" is displayed in status bar of home screen. Factory default is VRD off (except for Australia). Contact an authorized ESAB service technician to activate this function.
2. Preset welding current
Rotate main knob clockwise to increase preset welding current or anti-clockwise to decrease preset welding current.

3. Bottom bar of home screen

Displays status of welding process, arc force level, hot start level, job selection, and remote connection. To make any change or adjustment, press menu button to enter menu screen and navigate by turning main knob.

MMA/Stick menu screen



1. MMA/Stick menu screen

Process selection

Press main knob to enter process selection screen and select Stick (MMA) function by press main knob again.

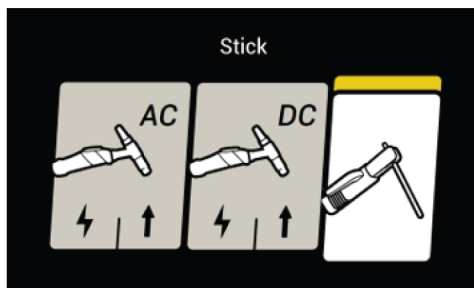

Electrode type

Select between rutile/basic electrode and cellulosic electrode by turning main knob and confirm selection by pressing main knob.

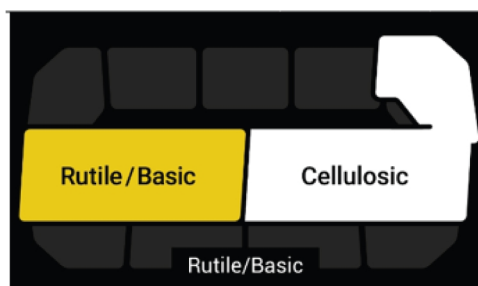

Hot start

The hot start function temporarily increases the current in the beginning of the weld, thus reducing the risk of lack of fusion in the starting point. Turn main knob to adjust hot start level on a scale of 1 to 10 in hot start screen. Confirm adjustment by pressing main knob and adjusted hot start level will be displayed in menu screen.

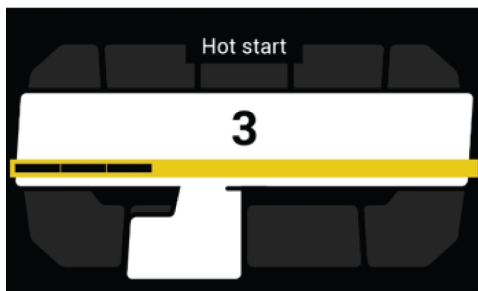

Arc force

The arc force function determines how the current changes in response to variations in arc length during welding. Use a low value of arc force to get a calm arc with little spatter and use a high value to get a hot and digging arc. Turn main knob to adjust arc force level on a scale of 1 to 10 in arc force screen. Confirm adjustment by pressing main knob and adjusted arc force level will be displayed in menu screen.

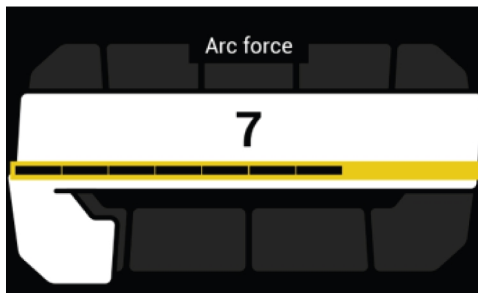

5.7.8 TIG welding



TIG welding melts the metal of the workpiece, using an arc initiated from a non-consuming tungsten electrode. The weld pool and electrode are protected by a shielding gas that usually consists of an inert gas.

For TIG welding, the welding power source shall be supplemented with:

- a TIG torch
- a gas hose connected to the gas supply input (using a hose clamp)
- an argon gas cylinder
- an argon gas regulator
- a tungsten electrode
- a return cable (with clamp)

Lift Arc TIG start and TIG HG start

This power source performs **Lift Arc TIG start** and **TIG HG start**.

Lift Arc TIG start



The LiftArc™ function initiates the arc when the tungsten electrode is brought into contact with the workpiece, the trigger switch is pressed, and the tungsten electrode is lifted away from the workpiece. In order to minimize the risk of tungsten contaminations the start current is very low and will slope up to the set current (controlled by the slope up function).

The tungsten electrode is placed against the workpiece and press the torch trigger. When lifted away from workpiece the arc is struck at a limited current level.

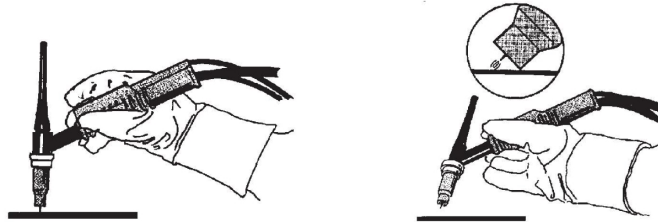

TIG HF start



The HF (High Frequency) start function initiates the arc by using a high frequency voltage pilot arc. This will reduce the risk of tungsten contamination in the starts. The high frequency voltage might disturb other electrical equipment in the surrounding area.

The HF start function strikes the arc by means of a spark from the tungsten electrode to the workpiece as the electrode is brought closer to the workpiece and the trigger on the TIG torch is pressed.

TIG home screen

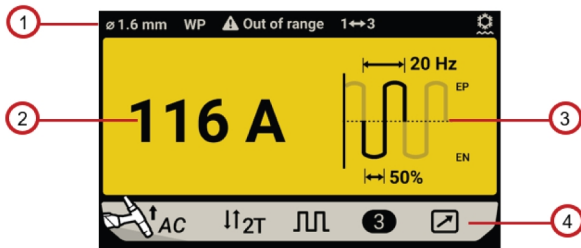

1. Bottom bar of TIG home screen

- Diameter of tungsten
Only available in AC TIG mode.
- Type of tungsten
Only available in AC TIG mode.
- Out of range
When the welding current is out of the tungsten limitation.
- Trigger job shift
Only available when this function is activated.
- Water cooler connection
Water cooling symbol is display in status bar when water cooler is connected.

2. Preset welding current

Rotate main knob clockwise to increase preset welding current or anti-clockwise to decrease preset welding current.

3. TIG welding

To change among basic view, sequencer view, Seq./ pulse view or AC settings view, press menu button and enter Settings menu. When AC setting view is selected, pressing main knob on home screen will jump to AC setting page directly.



Basic view / Sequencer view

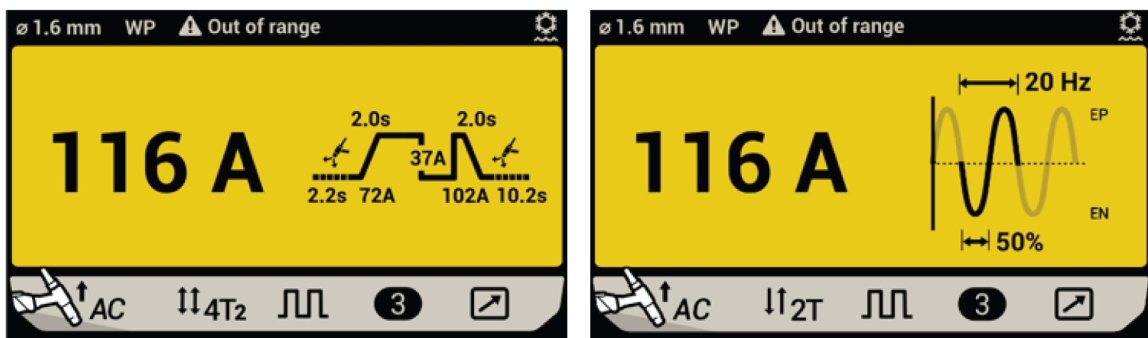

Seq./Pulse view / AC settings view

4. Bottom bar

Status of welding process selection, trigger mode, pulse, job selection, and remote connection. To make any change or adjustment, press menu button and navigate through each function by rotating main knob.

Sequencer/Pulse TIG home view

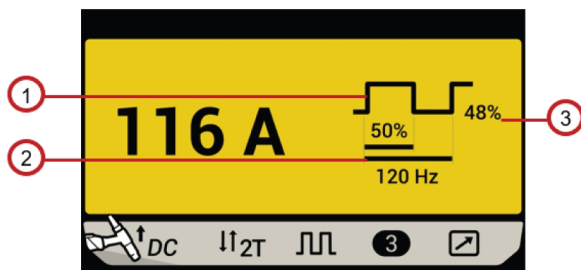

- 1. Peak time view
- 2. Frequency view

- 3. Background current view

Sequencer TIG home view

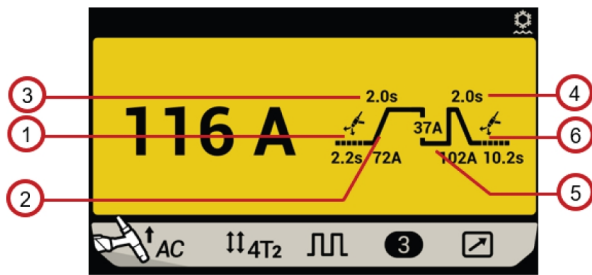

- | | |
|-----------------------|-----------------------|
| 1. Gas pre-flow view | 4. Slope down view |
| 2. Start current view | 5. Final current view |
| 3. Slope up view | 6. Gas post-flow view |

TIG menu screen

When Lift TIG or TIG HF is selected, press menu button to enter TIG menu screen.

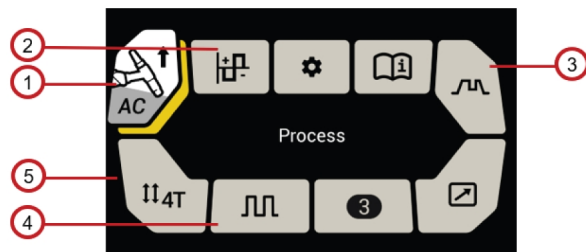

1. Process selection

Press main knob to enter process selection screen and select between Lift TIG or TIG HF when this icon is highlighted.

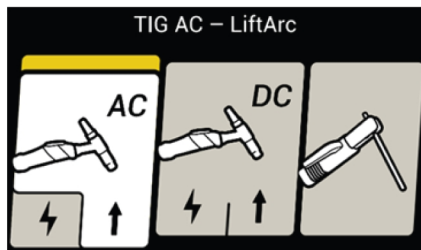

2. AC settings

Press main knob to enter AC settings screen and set different AC welding parameter, such as Balance/Frequency/Offset/Waveshape.

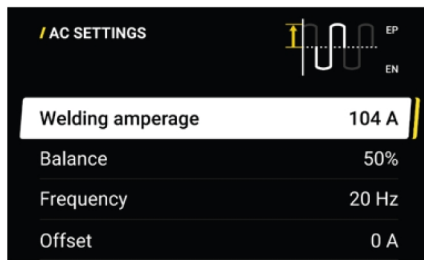

- Balance

Used to adjust the balance (%) in AC TIG advanced mode, it is the ratio between EP and EN in a waveform. Balance lets you control the arc width, heat, and cleaning action etc.

Benefits of increasing the balance (i.e., increasing the EN portion of the AC TIG waveform):

- Achieve greater penetration
- Helps in increasing travel speeds
- Helps in narrowing the weld bead
- Helps in increasing the tungsten electrode life and reduces balling action
- Reduces the size of etched zone for improved cosmetics

Benefits of decreasing the balance (i.e., increasing the EP portion of the AC TIG waveform):

- Better cleaning action to remove heavier oxidation on the work plate
- Minimizes penetration which help prevent burn-through on thin materials
- Widens the bead profile and helps in catching both sides of the joint



NOTE!

Adjust the balance with care. Decreasing the balance to a lower value at a particular weld current will have more balling action on the tungsten, which will reduce the tungsten electrode life and may lose arc stability.

- Offset

Offset feature in AC TIG is used to vary the EP or EN currents to have better cleaning or better penetration respectively without adjusting the balance (duty) and/or user set current. Offset gives the user ability to have a narrower bead with deeper penetration and no visible cleaning action or wider bead with less penetration and clear visible cleaning action based on which direction the offset is adjusted.

In AC TIG mode, the user can adjust the offset parameter which will range from - (user set current – MIN) to + (user set current – MIN). When using a foot pedal, the set value of MIN current affects the usable offset range. Example, if user set current is set to 104 A then the offset adjustable range is from -99 A to +99 A, because MIN current is 5 A and adding 5 A to 99 A results in 104. Another example: in the case of offset set to +15 A with a user set current of 104 A, the weld current drives to EP = 119 A and EN = 89 A.

See the following images for an example of AC TIG output current at different balance and/or offset settings.

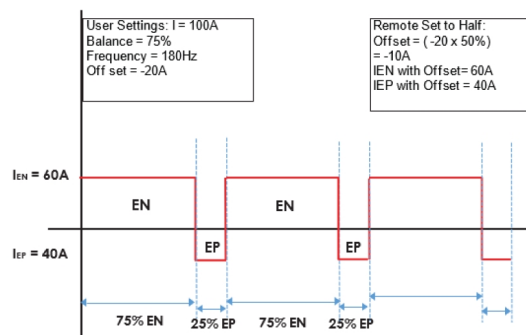
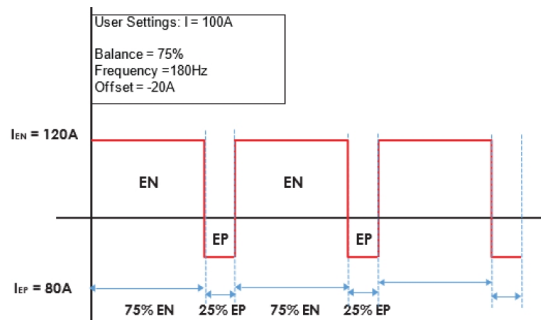
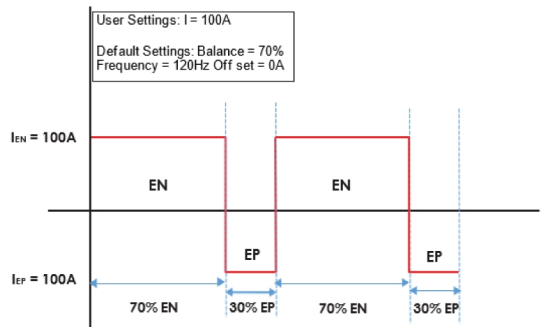

3. Sequencer settings

Enter sequencer settings screen by pressing main knob when sequencer icon is highlighted, and navigate through the sequencer by rotating main knob. To make adjustment of any process, press main knob when the process to adjust is displayed in yellow and rotate main knob to adjust value as displayed. Press main knob again to confirm value and exit adjustment mode.

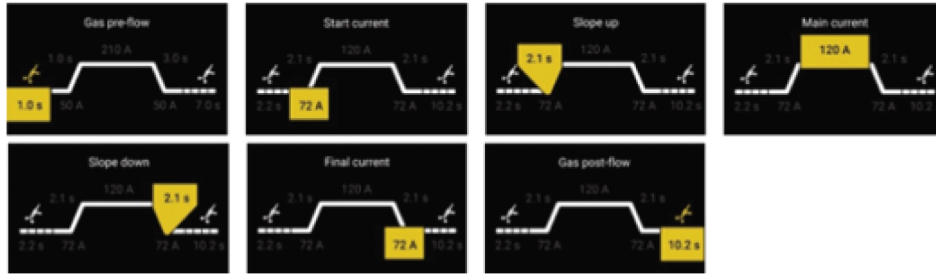

Gas pre flow

The gas pre flow function controls the time during which shielding gas flows before the arc is initiated. Setting range is 0.0-99.0 seconds. Factory default is 0.2 second.

Gas post flow

The gas post flow function controls the time during which shielding gas flows after the arc is terminated. Setting range is 0.0-99.0 seconds. Factory default is 6.0 seconds.

Slope up

The slope up function is used to control the time of the current increase in the weld initiation process to avoid any possible damage to the tungsten electrode. Setting range is 0.0-20.0 seconds. Factory default is 2 seconds.

Slope down

The slope down function is used to control the time of the current decrease in the weld termination process to avoid any pipes and/or cracks. Setting range is 0.0-20.0 seconds. Factory default is 2 seconds.

4. Pulse settings

In order to set a pulsed current, four parameters are required: pulse current, background current, pulse balance and pulse frequency.

Peak current

The higher of the two current values when using a pulsed current. Setting range is 5 to 230 A(DC)/15 to 230(AC).

Background current

The lower of the two current values when using a pulsed current. Setting range is between 5 to 230 A(DC)/15 to 230(AC).

Peak time

Peak time is the ratio between pulse current and background current in a pulse cycle. In order to control the energy of the arc and the size of the weld pool, peak time is adjustable by setting the percentage of the pulse current in a pulse cycle. Setting range is 10-90%, and increment value of each rotation of main knob is 1%. Factory default is 50%.

For example: If the peak time is set to 50%, the time of the peak current and the background current will be distributed equally in the pulse cycle. If the peak time is set to 90%, the time of the peak current will be 90% of the pulse cycle and the background current will only be 10%.

Frequency

The amount of pulse cycles in a time period. The higher the frequency, the more pulse cycles per time period. When the pulse frequency is set low, the weld pool will have time to partially solidify between each pulse. If the frequency is set high, a more focused arc can be obtained.

Setting range is 0.5-200 Hz. Factory default setting is 1 Hz.

0.1 (0.5 to 20 Hz)

1 (20-150Hz)

5. Trigger mode

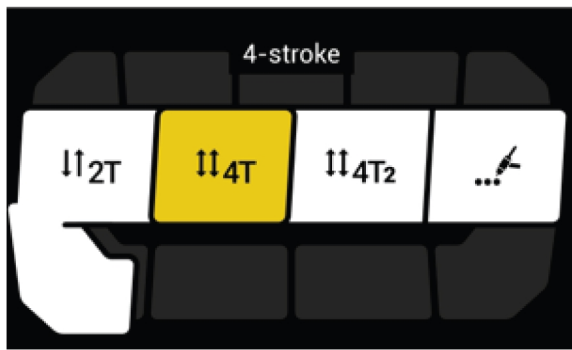
**2-stroke**

In 2-stroke mode, press the TIG torch trigger switch (1) to start the shielding gas flow and initiate the arc. The current slopes up to the set current value. Release the trigger switch (2) to start to slope down the current and terminate the arc. The shielding gas will continue to flow in order to protect the weld and the tungsten electrode.

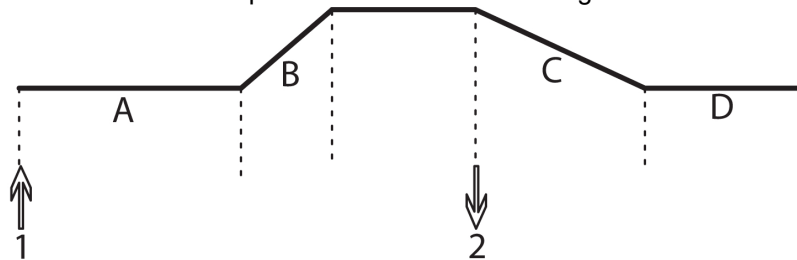

A = Gas pre flow

B = Slope up

C = Slope down

D = Gas post flow

**4-stroke**

In 4-stroke mode, press the TIG torch trigger switch (1) to start shielding gas flow and initiate the arc at a pilot level. Release the trigger switch (2) to slope up the current to the set current value. To stop the welding, press the trigger switch again (3). The current will slope down to the pilot level again. Release the trigger switch (4) to terminate the arc. The shielding gas will continue to flow in order to protect the weld and the tungsten electrode.

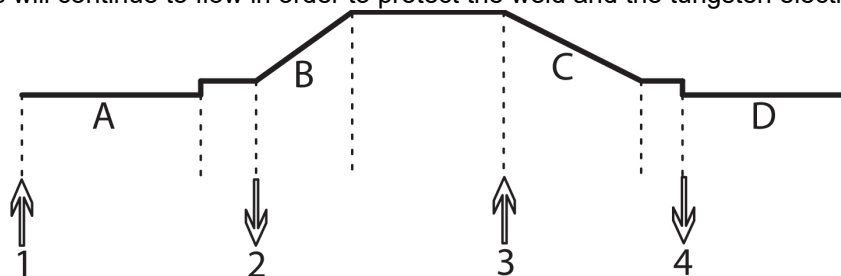

A = Gas pre flow

B = Slope up

C = Slope down

D = Gas post flow

↕↕ 4T₂

4T₂

4T₂ changes the value of secondary current that needs to be adjusted in sequencer after 4T₂ activation. 4T₂ current feature lets the user to switch to lower current during welding the corners or edges without stopping the weld.

4T₂ operation is available only in trigger mode when 4T₂ is enabled.

When 4T₂ mode is enabled, it can be activated by quick trigger tap action during welding. One quick tap on trigger (push and release) will switch the output weld current from "Main current" to "Secondary Current"; another quick tap on trigger will switch the current from "Secondary Current" to "Main Current", refer to following image.

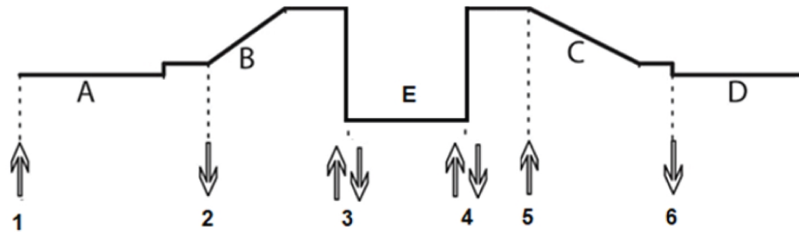

A = Gas pre flow

B = Slope up

C = Slope down

D = Gas post flow

E = Secondary current

Refer to the following image for the navigation or setup of 4T₂ Pulse in the Pulse screen.

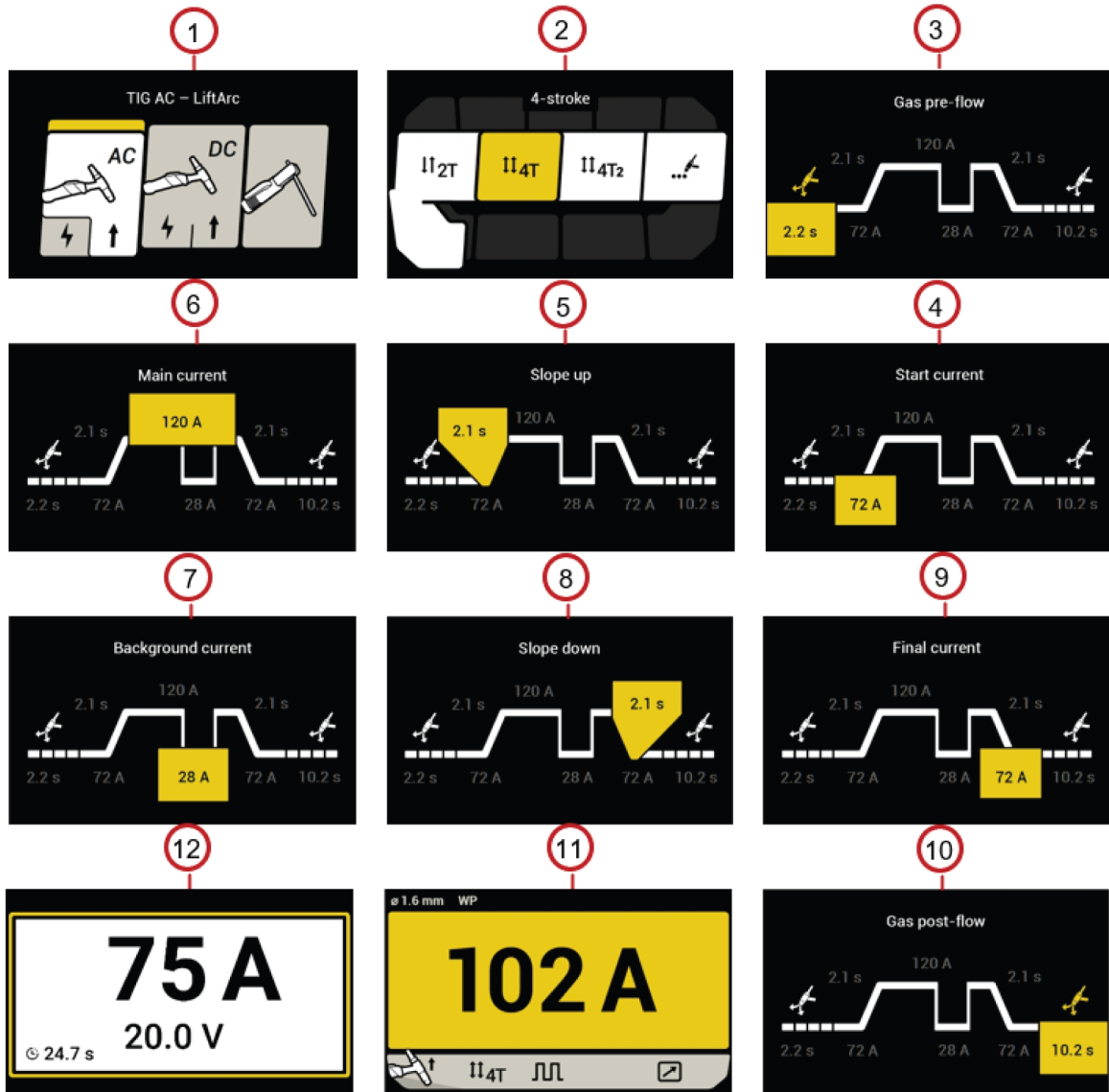

- | | |
|---------------------------------------|---|
| 1. Weld mode selection (ACTIG/DC TIG) | 7. Background current setting (Current B) |
| 2. Select 4T2 mode | 8. Slope down setting |
| 3. Pre-flow gas setting | 9. Final current setting |
| 4. Start current setting | 10. Post-flow gas setting |
| 5. Slope up setting | 11. Current setting and review |
| 6. Main current setting (Current A) | 12. Welding screen |



Spot mode

Spot welding is used to weld two thin plates together at a desired location by melting the top and bottom plates together to form a nugget between them. The spot time can be adjusted in the sequencer menu once spot mode active.

Refer to the following image for the the spot operation.

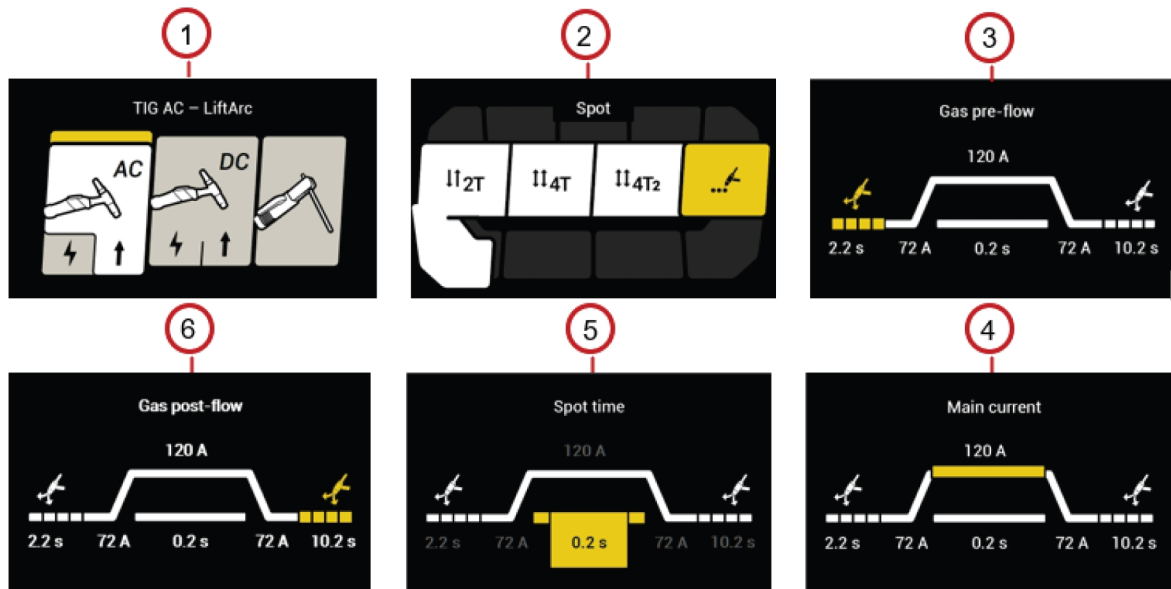

1. Weld mode selection (AC TIG/DC TIG)
2. Select spot mode
3. Pre-flow gas setting
4. Welding current setting
5. Spot time setting
6. Post-flow gas setting

Foot pedal functions explanation

Foot pedal with 2-stroke using TIG torch trigger

In 2-stroke mode, with the foot pedal activated, press the TIG torch trigger switch (1) to start the shielding gas flow and initiate the arc. The current slopes up to the set remote min current. Use the foot pedal to adjust the current between the remote min current and the set current value. Release the TIG torch trigger switch (2) to start to slope down the current and terminate the arc. The shielding gas will continue to flow in order to protect the weld and the tungsten electrode.

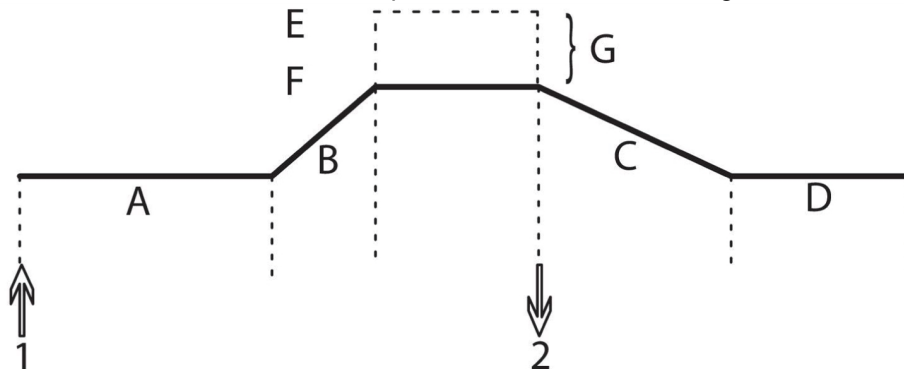

- | | |
|-------------------|--|
| A = Gas pre flow | E = Set current |
| B = Slope up | F = Remote min current |
| C = Slope down | G = Current range adjustable by the foot pedal |
| D = Gas post flow | |

Foot pedal with 4-stroke using TIG torch trigger

In 4-stroke mode, with the foot pedal activated, press the TIG torch trigger switch (1) to start the shielding gas flow and initiate the arc at a pilot level. Release the trigger switch (2) to slope up the current to the remote min current. Use the foot pedal to adjust the current between the remote min current and the set current value. To stop the welding, press the trigger switch again (3). The current will slope down to the pilot level again. Release the trigger switch (4) to terminate the arc. The shielding gas will continue to flow in order to protect the weld and the tungsten electrode.

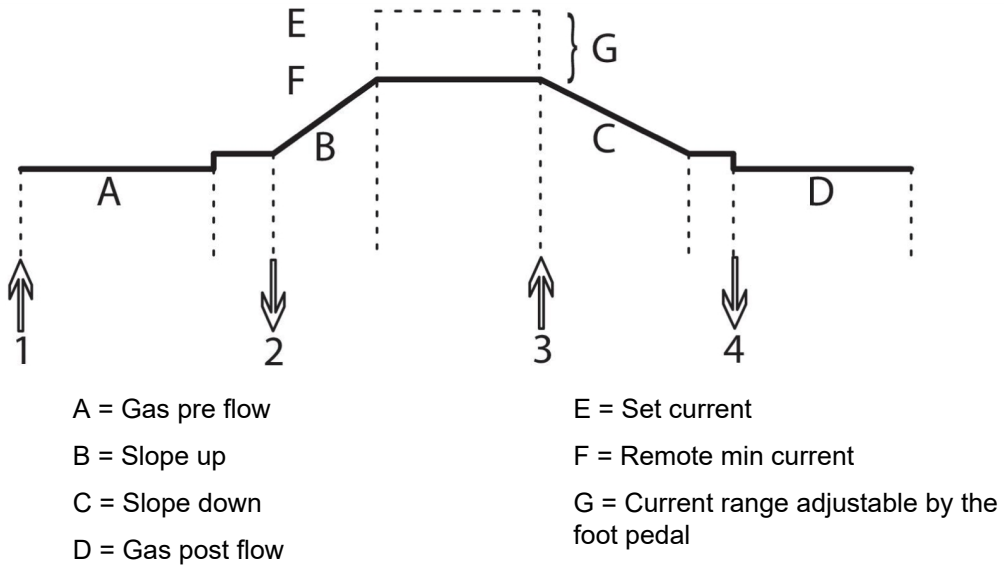

Foot pedal

Press down the foot pedal (1) to start the shielding gas flow and initiate the arc. The current slopes up to the set remote min current. Use the foot pedal to adjust the current between the remote min current and the set current value. Release the foot pedal to start to slope down the current and to terminate the arc. The shielding gas will continue to flow in order to protect the weld and the tungsten electrode.

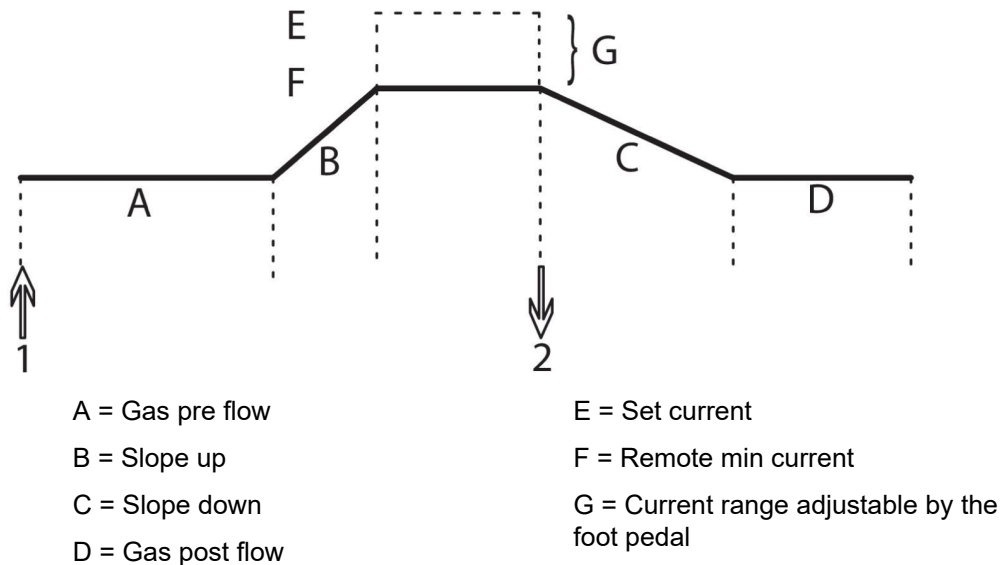

6 MAINTENANCE

**WARNING!**

The mains supply must be disconnected during cleaning and maintenance.

**CAUTION!**

Only persons with the appropriate electrical knowledge (authorised personnel) may remove the safety plates.

**CAUTION!**

The product is covered by manufacturer's warranty. Any attempt to carry out repair work by non-authorised service centers or personnel will invalidate the warranty.

**NOTE!**

Regular maintenance is important for safe and reliable operation.

**NOTE!**





Perform maintenance more often during severe dusty conditions.

Before each use - make sure that:

- Product and cables are not damaged,
- The torch is clean and not damaged.

6.1 Routine maintenance

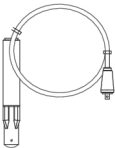
Maintenance schedule during normal conditions. Check equipment prior to every use.

Interval	Area to maintain		
Every 3 months	 Clean or replace unreadable labels.	 Clean weld terminals.	 Check or replace weld cables.
Every 6 months	 Clean inside equipment. Use dry compressed air with reduced pressure.		

6.2 Cleaning instructions

To maintain the performance and increase the lifetime of the power source it is mandatory to clean it regularly. How often depends on:

- the welding process
- the arc time

- the working environment



CAUTION!

Make sure that the cleaning procedure is done in a suitable prepared workspace.



CAUTION!

During cleaning, always wear recommended personal safety equipment, such as ear plugs, safety glasses, masks, gloves and safety shoes.

- 1) Turn off the machine and disconnect the power source from the mains supply.



WARNING!

Wait at least 5 minutes for the capacitors to discharge before continuing.

- 2) Remove the two screws in the right side and four screws in the top.

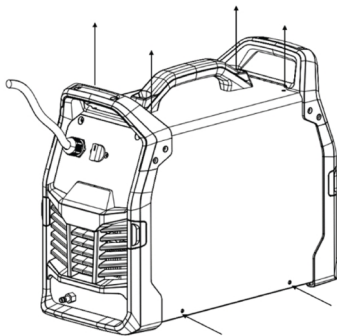

- 3) Remove the two screws in the left side panel.

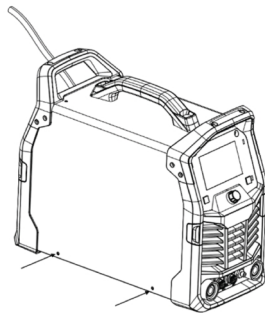

- 4) Remove the four screws in the bottom plate.

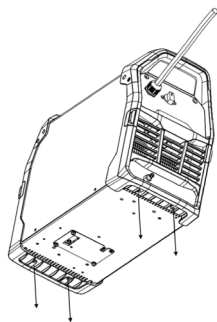

- 5) Bend the front and rear panel and lift the handle to remove the housing.

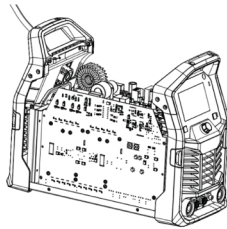
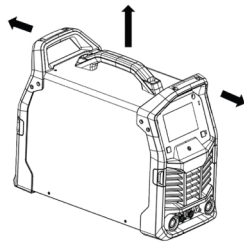

- 6) Clean the power source, using dry compressed air with reduced pressure.



NOTE!

Since the power source contains one "dirty side" (the right side) and one "clean side" (the left side), it is important that you do **not** remove the **left** side panel before cleaning the right side of the power source.

- 7) Make sure that there is no dust left on any part of the power source.
- 8) After having finished cleaning the power source, reattach the power source panels in the reverse order.



NOTE!

When reattaching the right side panel, make sure the IP shield on the inside of the panel is in the correct position. The IP shield should be angled approximately 90° into the power source, so that it is positioned between the welding outlet connector and the transformer outlets.

- 9) Tighten the screws on the side panels with 4 Nm ± 0.3 Nm (22.9 in lb. ± 2.6).

7 TROUBLESHOOTING

Perform these checks and inspections before sending for an authorised service technician.

Type of fault	Corrective action
MMA welding basic problems	Check that the welding and return cables are correctly connected on the power source.
	Make sure the return clamp has proper contact with the work piece.
	Check that the correct electrodes and polarity are being used. For polarity, check electrode packaging.
	Check that the correct current value is set.
	Adjust Arc Force and Hot start.
TIG welding problems	Check that the welding and return cables are correctly connected on power source.
	Make sure the return clamp has proper contact with the work piece.
	Make sure the TIG torch lead is connected to negative welding terminal.
	Make sure the correct shielding gas, gas flow, welding current, filler rod placement, electrode diameter, and welding mode on power source is used.
	Make sure the gas valve on the TIG torch is on.
No arc	Check that display is on to verify that the power source has power.
	Check setting panel display correct values.
	Check that the mains power supply switch is turned on.
	Check that the mains, welding and return cables are correctly connected.
	Check the mains power supply fuses.
Welding current is interrupted during welding	Check whether the overheating light (thermal protection) at setting panel is on.
	Continue with fault type "No Arc".
The thermal protection trips frequently	Make sure the recommended duty cycle for the weld current has not been exceeded (see section "Duty cycle" in the TECHNICAL DATA chapter).
	Make sure the air inlets or outlets are not clogged.
	Clean inside machine according to routine maintenance.

Type of fault	Corrective action
Porosity within the weld metal	Check that the gas bottle is not empty.
	Check that the gas regulator is not closed.
	Check gas inlet hose for leaks or blockage.
	Check that the correct gas is connected, and the correct gas flow is used.
	Keep the distance between the MIG torch nozzle and the work piece to a minimum.
	Do not work in areas where drafts, which would disburse the shielding gas, are common.
	Make sure the work piece is clean, with no oil or grease on the surface, before welding.

Fault symptom	Action
Cooling	
Leakage from the hoses.	Check that the hose clamps are properly tightened and that the hoses are not damaged.
Leakage at the weld tool.	Check that an O-ring is correctly located at the back end of the tool and that the O-ring is not damaged.

8 ERROR CODES

The error code is used to indicate that a fault has occurred in the equipment. Errors are indicated by the text "Error" followed by the error code number and description shown in the display.

Error log

The equipment displays the number of times each error has occurred.

8.1 Error code descriptions

Error codes that the user can handle are listed below. If any other error code appears, contact an authorized ESAB service technician.

Error code	Title	Display information	Description	Action
209:01	Mains Power Over Voltage	Error 20901 Mains power over voltage	The product has detected that the incoming mains power is outside of the product specifications.	Make sure that the mains power is within the product specification.
209:02	Mains Power Under Voltage	Error 20902 Mains power under voltage	The product has detected that the incoming mains power is outside of the product specifications.	Make sure that the mains power is within the product specification.
206:02	Over Temperature	Error 20602 Over Temperature	The product has overheated and shutdown to allow the fan to cool it down. Welding can resume once the unit has cooled.	Wait until the temperature cools down.
114:01	Communication fault	Error 11401 Internal communication error	Communication error between PC CTRL and HMI.	Check the connection between HMI to main control PCB board.

9 ORDERING SPARE PARTS



CAUTION!

Repair and electrical work should be performed by an authorised ESAB service technician.
Use only ESAB original spare and wear parts.

The Rogue ET230 iP AC/DC is designed and tested in accordance with international standards **IEC-/EN 60974-1**, **IEC-/EN 60974-5** and **IEC-/EN 60974-10**. It is the obligation of the authorized service center carrying out the service or repair work to ensure that the product still conforms to the aforementioned standards.

Spare parts and wear parts can be ordered through your nearest ESAB dealer, see [esab.com](https://www.esab.com). When ordering, please state product type, serial number, designation and spare part number in accordance with the spare parts list. This facilitates dispatch and ensures correct delivery.

The spare parts list is published in a separate document that can be downloaded from the Internet:
www.esab.com

ORDERING NUMBERS





Ordering number	Denomination	Type	Notes
0700 500 214	Power source	Rogue ET 230iP AC/DC	CE Version
0700 500 209	Instruction manual	Rogue ET 230iP AC/DC	
0700 500 210	Spare parts list	Rogue ET 230iP AC/DC	

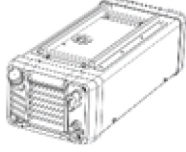
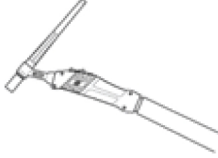
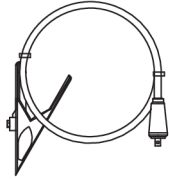

The three last digits in the document number of the manual show the version of the manual. Therefore they are replaced with * here. Make sure to use a manual with a serial number or software version that corresponds with the product, see the front page of the manual.

Technical documentation is available on the Internet at: www.esab.com

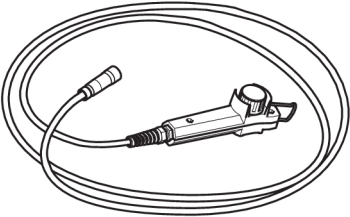
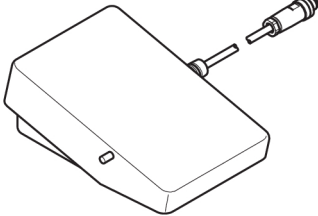
ACCESSORIES

0448 040 880	Coolmini3	
0700 026 220	Exeor TIG SR 17 torch, Air , 4 m	
0700 026 221	Exeor TIG SR 17 torch, Air , 8 m	
0700 026 234	Exeor TIG SR 17-R torch, Air , 4 m	
0700 026 235	Exeor TIG SR 17-R torch, Air , 8 m	
0700 026 290	Exeor TIG SR 21 torch, Water, 4 m	
0700 026 291	Exeor TIG SR 21 torch, Water, 8 m	
0700 026 294	Exeor TIG SR 21-R torch, Water, 4 m	
0700 026 295	Exeor TIG SR 21-R torch, Water, 8 m	
0700 006 901	Return cable kit, OKC 50, 3 m	
0700 006 889	Return cable kit, OKC 50, 5 m	
0700 006 900	Electrode holder Handy, 200 A with 25 mm ² , 3 m, OKC 50	
0700 500 084	Remote control, MMA 4	
W4014450	Foot pedal with 4.5 m (15 ft) cable, 8 PIN	

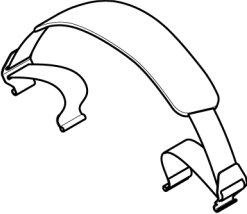
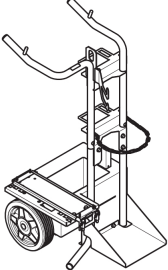
APPENDIX

<p>0445 197 880</p>	<p>Shoulder strap</p>	
<p>0460 330 881</p>	<p>Trolley</p>	
<p>0465 720 002 0007 810 012</p>	<p>ESAB coolant</p>	



A WORLD OF PRODUCTS AND SOLUTIONS.



For contact information visit <http://esab.com>

ESAB AB, Lindholmsallén 9, Box 8004, 402 77 Gothenburg, Sweden, Phone +46 (0) 31 50 90 00

manuals.esab.com

