

GAMMA RESPIRATORY MODELS

A safe breathing environment throughout your working day

The Gamma GTH3 welder's respirator range contains five models offering the best protection for your lungs and long-term health. Supplying clean fresh air from either a battery powered filter unit or airline breathing air source, Gamma GTH3 positive pressure respirators create a cool, comfortable and safe breathing environment throughout your working day. Gamma GTH3 models are certified to a maximum allowable inward leakage of 0.2 %, so 99.8 % efficient.

For further information on Kemppi powered filter units and supplied air regulators, please see page 31.

Positive pressure, clean breathing air lowers breathing resistance and fatigue. Fresh air flow rates can be adjusted to suit your preference. PAPR filter options include both particle and gas filters. See page 32.



GAMMA FOR SUPPLIED AIR

Long work periods, lower costs

Connected to a certified breathing air source via an airline and belt-mounted regulator RSA 230, Gamma GTH3 Airline models provide an alternative to the battery powered systems. SFA and PFA models include alternative welding lens options suiting differing user needs, featuring the automatic welding lens SA 60 ADF or a passive welding lens.

Gamma GTH3 SFA (RSA 230)

- LiFE+ Color auto-darkening welding filter SA 60
- Viewing area 102 x 60 mm, 61 cm²
- Shade selections 5, 8, 9, 10, 11, 12, 13
- Protected remote control buttons
- Visible ADF parameter selection when wearing
- Clear optics for improved work accuracy
- Magnifying lens option
- RSA 230 belt mounted regulator and silencer
- All Gamma comfort and safety features

Gamma GTH3 PFA (RSA 230)

- Passive welding filter 102 x 74 mm
- 198 cm² grinding visor with 170° work site view
- RSA 230 belt mounted regulator and silencer
- All Gamma comfort and safety features





RSA 230

RSA 230 regulation valve enables a controlled air flow to the welder's respirator head-top fitted with a fabric face seal, and is supplied together with Gamma and Beta supplied air models. The positive air pressure created inside the head-top controls the ingress of contaminated air to the breathing zone and ensures a supply of clean breathing air. The RSA 230 regulation valve features a replaceable silencer, decreasing audible airflow noise and is mounted to a comfort back pad, secured to the body with a leather belt.

RSA 230

- Supports Gamma and Beta respirators
- Cost efficient alternative to PAPR models
- Recommended for specified environments
- Comfortable and light in weight
- Alarm alert should the air flow fall below 120 lpm
- Quick release connector to the Airline
- Easily adjusts airflow to the breathing zone
- Must be connected with known breathing air source.



Supplied breathing air solutions offer excellent protection and costs efficiency.



GAMMA GTH3 SFA + RSA 230



Gamma GTH3 SFA RSA 230 9873150

Gamma GTH3 SFA welding helmet, auto-darkening welding filter SA 60, supplied air regulator RSA 230, air hose for RSA 230, flow meter, Gamma leather belt.

Spare parts

Gamma GTH3 SFA welding helmet	SP013232
Protection plate, 5 pcs	SP008034
ADF welding filter SA 60 (shades 5, 8, 9-13)	SP012422
Inner protection plate (106.5 x 65.5), 5 pcs	SP012425
Grinding visor, 5 pcs	SP008040
Side cover plate	SP012053
Headband	SP009023
Neck band	SP010728
Remote control for SA 60, XA 74	SP012097
Sweatband, 2 pcs	SP9873018
Comfort band padding, 5 pcs	SP013231
Welding visor frame assembly	SP007996
Visor knob and adjuster set	SP008152
Supplied air regulator set RSA 230	SP011617
Air duct for PFA, SFA	SP012157
Air duct nozzle	SP010639
Work light solid cover plate, 3 pcs	SP011026
Air hose adapter for RSA 230	SP011227
Air hose	SP012253
Silencer for RSA 230, 2 pcs	SP011735
Hose protection cover	SP010788
Flow meter	SP012492

Magnifying lenses

Diopter 1.0 (51 x 108 mm)	9873260
Diopter 1.5 (51 x 108 mm)	9873261
Diopter 2.0 (51 x 108 mm)	9873262
Diopter 2.5 (51 x 108 mm)	9873263

Accessories

Face seal	SP009794
Belt assembly	SP012999
Gamma leather belt	SP010243
Shoulder harness	SP011894
Kemppi tool bag	SP010090
Pressure hose, 10 m	SP013848
Pressure hose, 20 m	SP013849
Pressure hose, 30 m	SP013850

SP008034

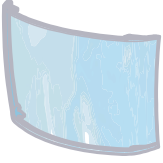

SP012422

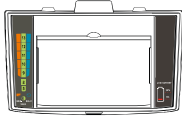

SP012425



SP008040

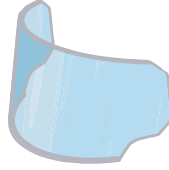

SP012053

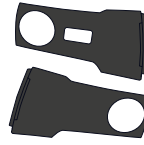

SP9873018

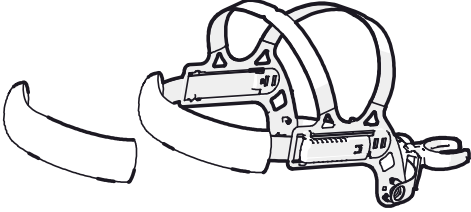

SP009023

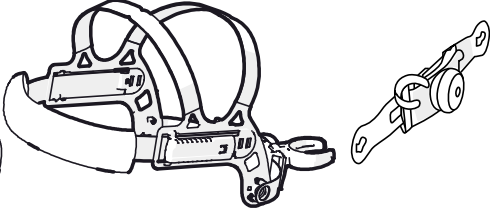

SP010728

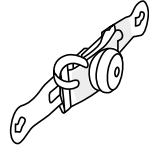

SP009794



9873260

9873261

9873262

9873263



SP013231



SP007996

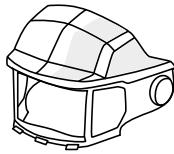

SP008152

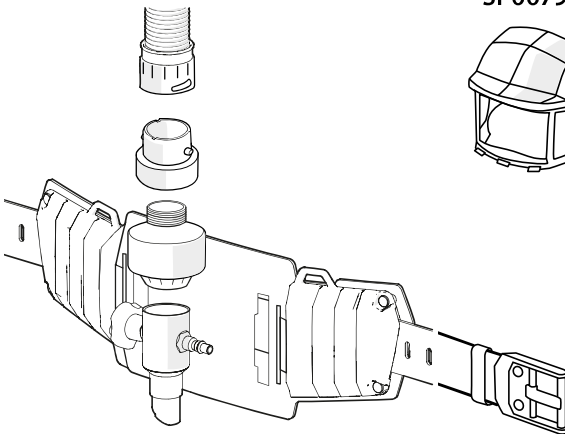
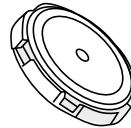

SP012157

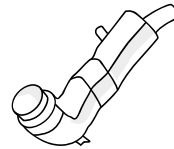

SP010639

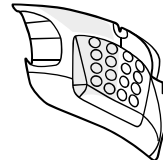

SP011026

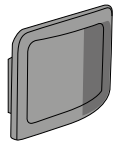

SP012999

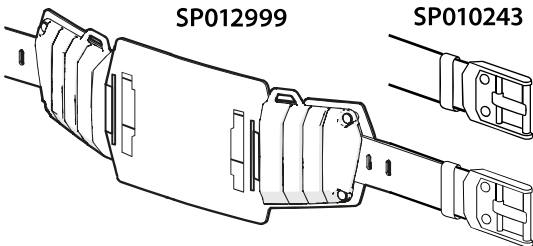

SP010243

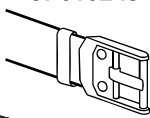

SP011617

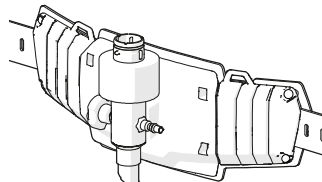

SP012857

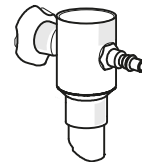

SP011735

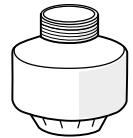

SP011894

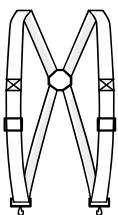

SP010090



SP012492

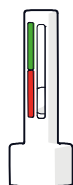

SP012253

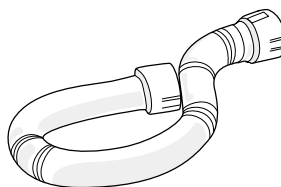

SP011227



W007788

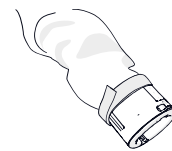

SP013848

SP013849

SP013850

