

SIF RANGE

SIF-700/900/1200/1500/1800/1900/2000 LI/RI

Extraction fan with straight blades to be used in central welding fume extraction systems or general filtration systems. It is mounted in a sound absorbing case with inspection cover either left ("LI" type) or right ("RI" type). The fan is equipped with flexible inlet and outlet adapters and placed on shock absorbers.

In case it is combined with a central filter unit, the fan has to be connected to the *outlet* side of the filter unit.



APPLICATIONS

The fan is intended to be used in the following configurations:

- multiple arm systems
- modular extraction hood systems
- push-pull systems



SPECIFICATIONS

Physical properties

Material:	<ul style="list-style-type: none"> • fan • housing 	<ul style="list-style-type: none"> • steel • steel with aluminium profiles and corners
Motor design	IEC 132 (WEG)	
Discharge position	RD 0	
Fan type	radial	
Design conditions	20°C (68°F) at sea level	

Performance

Speed of revolutions	2850 rpm
Noise level according to ISO 3746 (fan without sound absorbing case)	<i>refer to attached fan curves</i>
Noise reduction sound absorbing case	approx. 10 dB(A)

Electrical data

Connection voltage	400-690V/3ph/50Hz
Max. start/stops per hour	20
Insulation class	F with PTC
Protection class	IP 55



Ambient conditions

Operating temperature:	<ul style="list-style-type: none"> • min. • nom. • max. 	<ul style="list-style-type: none"> • 5°C (41°F) • 20°C (68°F) • 60°C (140°F)
Max. relative humidity	80%	
Storage conditions	<ul style="list-style-type: none"> • 5-60°C (41-140°F) • relative humidity max. 80% 	

Options and accessories

Mounting frame	<i>refer to table on page 3</i>
Silencer (straight or elbow 90°)	<i>refer to table on page 3</i>
SIF outdoor; fans suitable for outdoor use (rain-resistant)	<p>Outdoor kit consists of:</p> <ul style="list-style-type: none"> • rain cover over sound absorbing case, including coupler for duct or silencer • ventilation grids provided with rain cover • seams of the absorbing case being fully sealed (except for the inspection cover) <p>SIF outdoor</p> <ul style="list-style-type: none"> • -20°C (-4°F) • 20°C (68°F) • 60°C (140°F)
Operating temperature:	<ul style="list-style-type: none"> • min. • nom. • max.
Scope of supply	
Extraction fan in sound absorbing case - Key - Strain relief	
Order information	
Number/package	1
Shipping data	
Harmonized Tariff Code	8414.5940.90
Country of origin	Netherlands

APPROVALS/CERTIFICATES

	
	Motor fan
	Directive 2011/65/EC (RoHS) valid as of 8 June 2011

FAN CURVES (QUICK REFERENCE GUIDE)

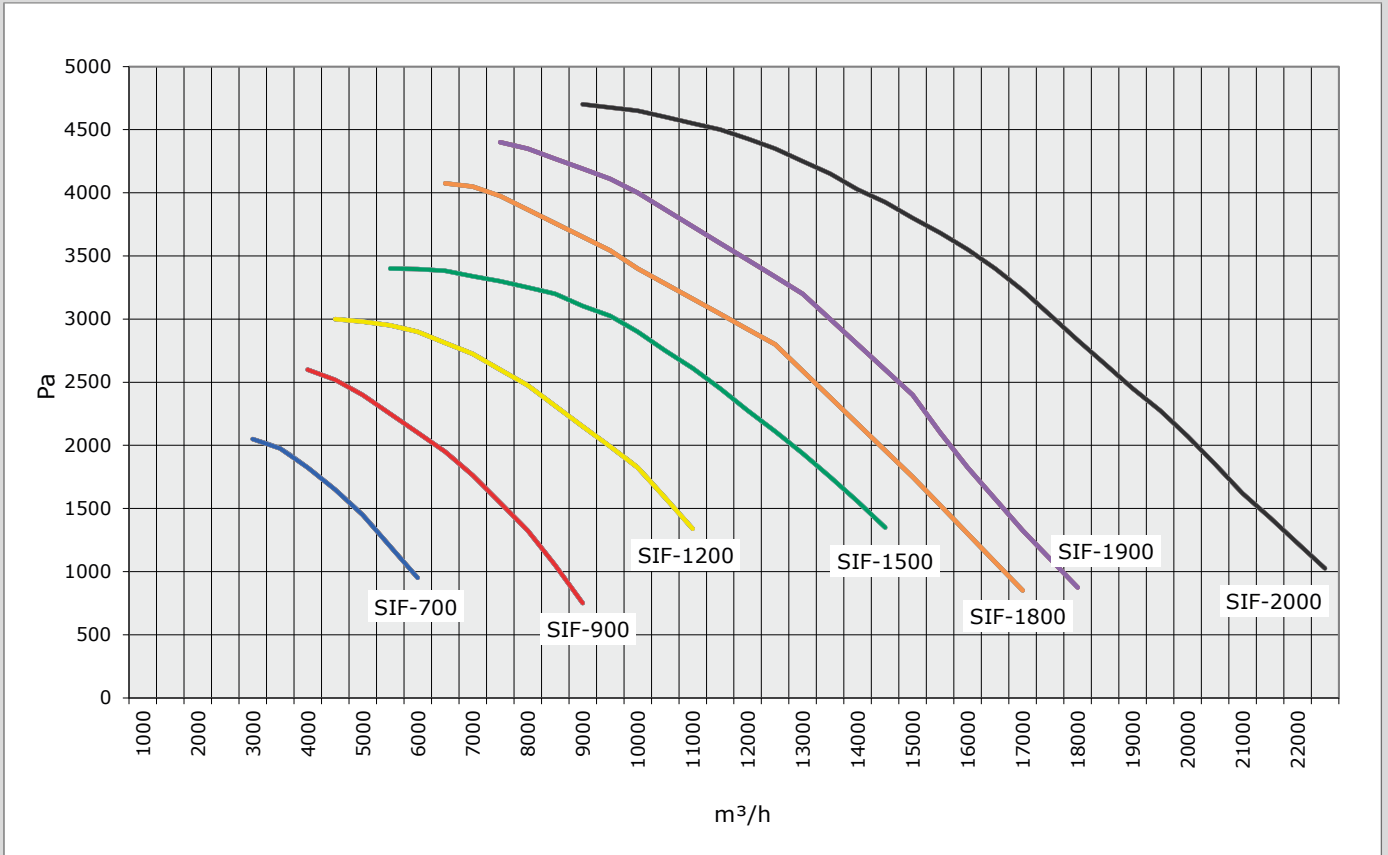

Detailed fan curves: refer to attachments

INSPECTION COVER

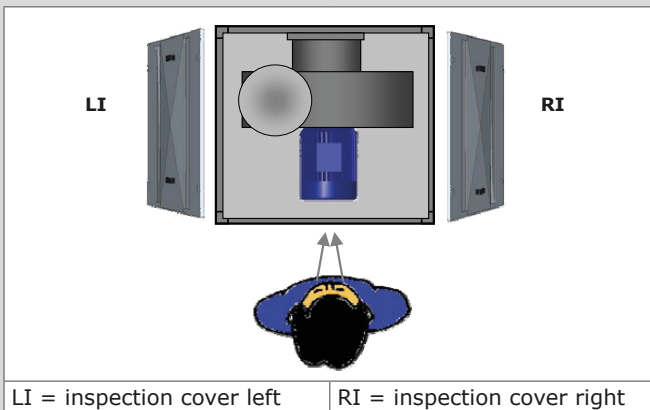

LI = inspection cover left | RI = inspection cover right

Remaining specifications: refer to table on next page.

Table: remaining specifications

	SIF-700		SIF-900		SIF-1200		SIF-1500		SIF-1800		SIF-1900		SIF-2000	
■ Electrical data														
Power	kW	HP	kW	HP	kW	HP	kW	HP	kW	HP	kW	HP	kW	HP
	3	4	5,5	7	7,5	10	11	20	15	20	18,5	25	22	30
Nominal current	5,81 A		10,6 A		13,6 A		21,0 A		28,0 A		34,2 A		38,7 A	
■ Available options														
Mounting frame	Refer to selection table below													
Silencer (straight or elbow 90°)	mm	inch	mm	inch	mm	inch	mm	inch	mm	inch	mm	inch	mm	inch
	Ø 400	Ø 15.7	Ø 500	Ø 19.7	Ø 500	Ø 19.7	Ø 630	Ø 24.8	Ø 630	Ø 24.8	Ø 630	Ø 24.8	Ø 630	Ø 24.8
■ Dimensions (ref. image below) and weight														
	mm	inch	mm	inch	mm	inch	mm	inch	mm	inch	mm	inch	mm	inch
A, B, G	1000	39.4	1100	43.3	1100	43.3	1300	51.2	1300	51.2	1300	51.2	1400	55.1
C (interior)	Ø 400	Ø 15.7	Ø 400	Ø 15.7	Ø 400	Ø 15.7	Ø 400	Ø 15.7	Ø 630	Ø 24.8	Ø 630	Ø 24.8	Ø 630	Ø 24.8
D	500	19.7	550	21.7	550	21.7	650	25.6	650	25.6	650	25.6	700	27.6
E, I	336	13.2	354	13.9	372	14.6	400	15.7	400	15.7	400	15.7	425	16.7
F (interior)	Ø 400	Ø 15.7	Ø 500	Ø 19.7	Ø 500	Ø 19.7	Ø 630	Ø 24.8	Ø 630	Ø 24.8	Ø 630	Ø 24.8	Ø 630	Ø 24.8
H	530	20.9	571	22.5	612	24.1	669	26.3	669	26.3	669	26.3	715	28.1
J	910	35.8	1010	39.8	1010	39.8	1210	47.6	1210	47.6	1210	47.6	1310	51.6
Weight (net)	kg	lbs	kg	lbs	kg	lbs	kg	lbs	kg	lbs	kg	lbs	kg	lbs
	175	386	225	496	250	551	325	717	335	739	350	772	400	882
■ Order information														
Article number:														
• SIF/LI	7906061020		7906061120		7906060220		7906060320		7906061220		7906061320		7906060920	
• SIF/RI	7906061010		7906061110		7906060210		7906060310		7906061210		7906061310		7906060910	
• SIF/LI outdoor	0000102170		0000102172		0000102174		0000102176		0000102178		0000102180		0000102182	
• SIF/RI outdoor	0000102169		0000102171		0000102173		0000102175		0000102177		0000102179		0000102181	
■ Shipping data														
Gross weight (incl. pallet)	kg	lbs	kg	lbs	kg	lbs	kg	lbs	kg	lbs	kg	lbs	kg	lbs
	190	419	240	529	265	584	340	750	350	772	365	805	420	926

■ Dimensions (ref. table above)

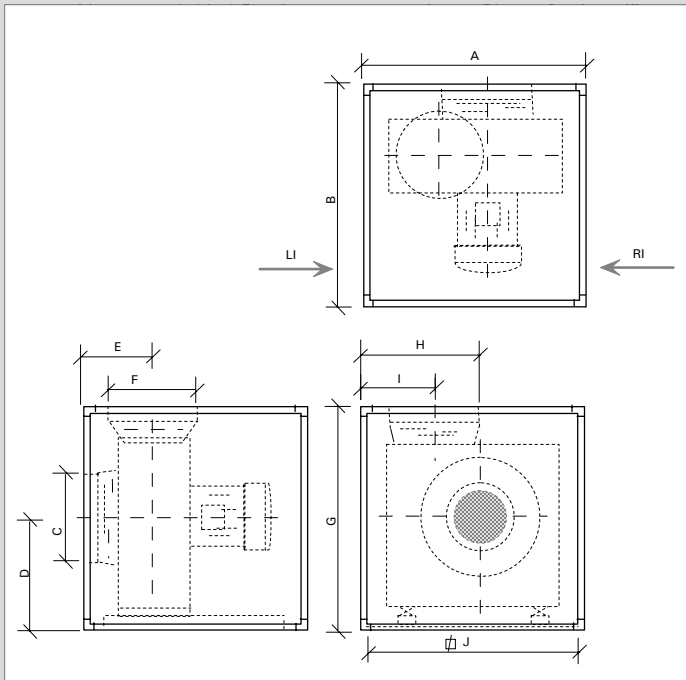

SELECTION TABLE: FAN MOUNTING FRAMES

Fan type	Filter system	Mounting frame ^{*)}
SIF-700	MDB-6 ^{**)}	Frame SIF-700/M
	SCS	Frame SIF-700/S
SIF-900/1200	MDB-8	Frame SIF-900/M
	MDB-6	Frame SIF-900/1200
	MDB-10 ^{**)}	Frame SIF-900/1200
	SCS	Frame SIF-900/1200
SIF-1500/1800/1900	MDB-12/16	Frame SIF-1500
SIF-1500	SCS	Frame SIF-1500
SIF-2000	MDB-20 ^{**)}	Frame SIF-2000/M
	SCS	Frame SIF-2000/S

*) The frame height is based on MDB units with a vertical outlet.
 **) This concerns configurations consisting of filter modules MBD-BM/2 and MDB-BM/4. Filter module MDB-BM/2 to be mounted *underneath* MDB-BM/4.

Product type	SIF range
Article no.	refer to order information
Product category	central fans
Version	101013/G

Always check the latest version on www.plymovent.com

SIF-1900 | 18,5 kW (25 HP)

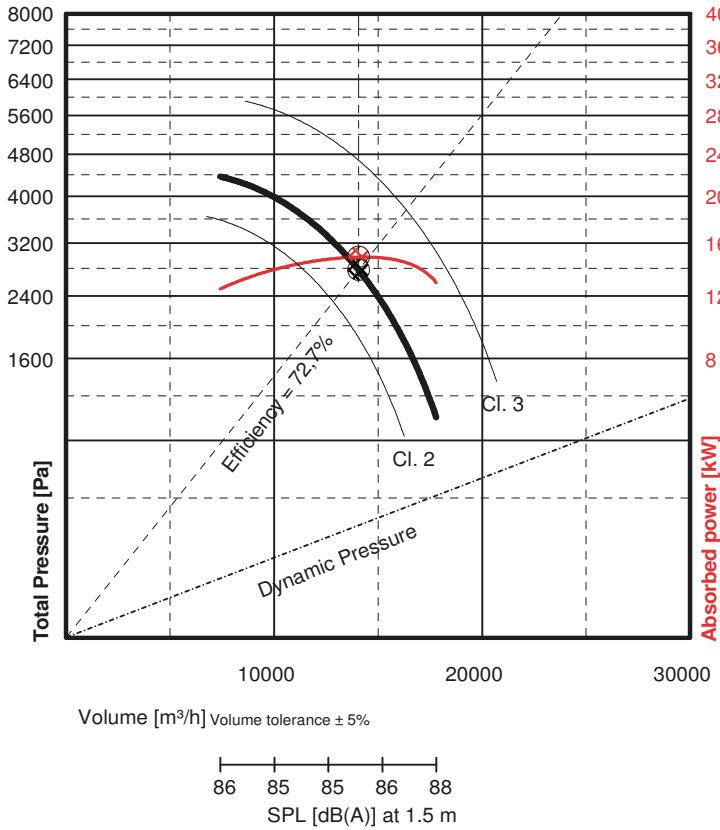

— Volume/pressure curve
— Volume/power curve

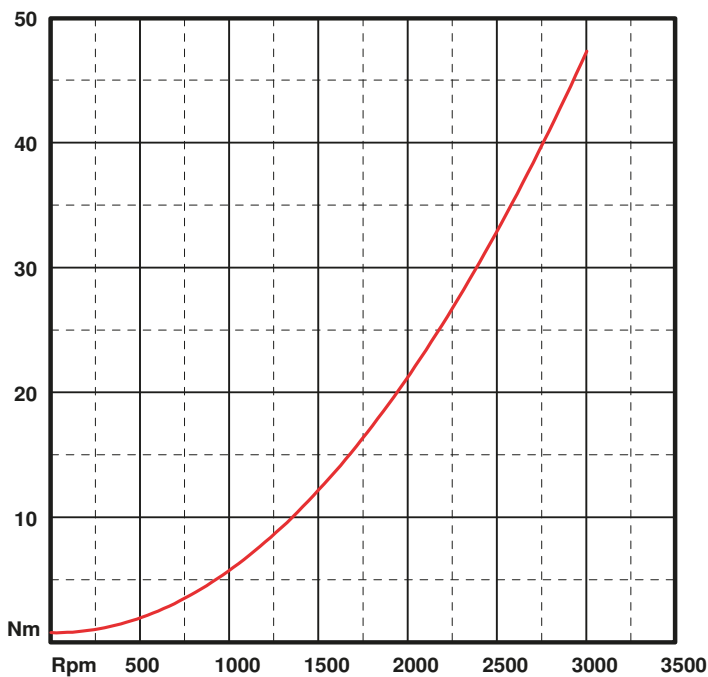

— Motor curve