



Cable Connectors	6
Electrode Holders	7
Earth Clamps	8
Cable Lugs	9
Copper Cable	10
Cable Lead Sets	11
Electrode Storage	12
Carbon Arc Gouging	13
Arc Accessories / Tools	14-15
Electrodes	16-17

# Manual Metal Arc

# Manual Metal Arc Cable Connectors

## Cable Plugs & Sockets

Futuris Dinze type connectors

- Top quality version of the European industry standard welding cable connectors
- Simple and safe: just plug in and tighten by a short strong turn for positive stop-lock action and maximum conductivity



**FUTURIS**

Code	Description
010350	10-25mm <sup>2</sup> Plug
010354	35-50mm <sup>2</sup> Plug
010347	50-70mm <sup>2</sup> Plug
010357	70-95mm <sup>2</sup> Plug



**FUTURIS**

Code	Description
010351	10-25mm <sup>2</sup> Socket
010355	35-50mm <sup>2</sup> Socket
010348	50-70mm <sup>2</sup> Socket
010358	70-95mm <sup>2</sup> Socket

## Panel Plugs & Sockets

Futuris Dinze type connectors

- Top quality version of the European industry standard welding cable connectors
- Simple and safe: just plug in and tighten by a short strong turn for positive stop-lock action and maximum conductivity



**FUTURIS**

Code	Description
010353	10-25mm <sup>2</sup> Plug
010349	35-50mm <sup>2</sup> Plug



**FUTURIS**

Code	Description
010352	10-25mm <sup>2</sup> Socket
010356	35-50mm <sup>2</sup> Socket
010346	50-70mm <sup>2</sup> Socket
010359	70-95mm <sup>2</sup> Socket

## Power Adaptor

Allows a 35-50mm<sup>2</sup> plug to be used on a 10-25mm<sup>2</sup> socket.



**FUTURIS**

Code	Description
TRACX70	Power Adaptor

## CC17 / CC18 Type Plug & Socket

- High quality heavy duty connectors
- Positive lock
- Accepts up to 70mm<sup>2</sup> cable



CC18



CC17

**FUTURIS**

Code	Description
010343	CC17 Type Plug
010344	CC18 Type Socket

## TT - Twist Type

Twist type short stub electrode holders available in both 400 and 600 Amps. Built with comfort & performance in mind and designed to reduce overheating.



FUTURIS™



FUTURIS™

PG Econ 405 and 605 Equivalent

Code	Description
010433	400 Amps
010434	600 Amps

## Optimum Type

- Closed head for safety
- 3 electrode positions
- Side lever for opening chamber to hold electrode



FUTURIS™

Code	Description
010415	300 Amps
010426	400 Amps
010427	500 Amps

## Crocodile Type

Crocodile jaws, popular with many welders for their ease of use.



FUTURIS™

Code	Description
010320	150 Amps
010317	200 Amps
010318	400 Amps



FUTURIS™

Handicool Equivalent

Code	Description
010325	400 Amps
010324	600 Amps

## Myking Type

- Designed to reduce overheating
- Straight head allows excellent visibility of production work
- Good manoeuvrability - great for tight spaces
- Excellent for vertical welding
- Rubber handle for better grip



FUTURIS™

Code	Description
010321	200 Amps
010322	400 Amps
010323	600 Amps

# Manual Metal Arc Earth Clamps

## Crocodile Type

- Most popular earth clamps, built to the highest standards
- Copper braid & brass contacts

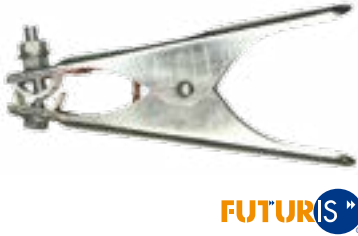

FUTURIS

Code	Description
010230	150 Amps
010231	200 Amps
010232	400 Amps



Genuine Nevada

Code	Description
010260	200 Amps
010261	300 Amps
010262	400 Amps

## Screw Type

- Ideal for the most extreme and demanding applications
- Robust with wide jaws



FUTURIS

cast / brass upper

Code	Description
010233	600 Amps

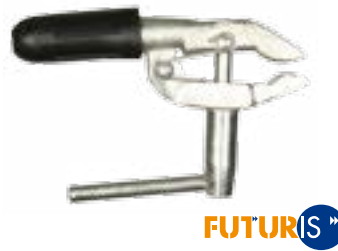

FUTURIS

all cast

Code	Description
010235	600 Amps

## Drop Forged

- A very robust drop-forged 600 Amp earth clamp with a wide jaw opening
- Equivalent to CC11 type

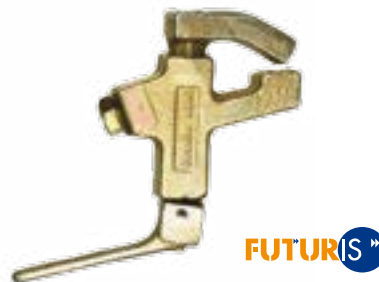

FUTURIS

Code	Description
010234	600 Amps

## Myking Type

- Popular Myking type
- Parallel connectors for increased earthing effect
  - Easy-to-use, even in restricted areas
  - Rubber handle for protection against damp and corrosion



FUTURIS

Code	Description
010237-MYK	600 Amps

### Other Earth Clamps

- Battery clamps
- Excellent physical & electrical properties
- Colour coded - red & black



Code	Description
010227	Red 150 Amps
010228	Black 150 Amps

- Magnetic earth clamp
- No jaw to open or break
- Holds on to mild steel, stainless & cast



Code	Description
010236	300 Amps

### Reusable & Crimp Lugs

- Reusable
- Simple fitting
- Long life



Code	mm <sup>2</sup>	Amps
010211	16	150
010212	25	200
010213	35	300
010214	50	400
010215	70	600

- Crimp fitting



Code	mm <sup>2</sup>	Tube Size
010216	25	10mm
010217	35	10mm
010218	50	12mm

### Knock-On & Hammer-On Lugs

- Knock-On
- Low cost
- Easy to fit



Code	mm <sup>2</sup>	Amps
010223	35	300
010224	50	400

- Hammer-On
- Hammer blow makes a solid connection
- Excellent pull-out strength without soldering or bolting



Code	mm <sup>2</sup>	Amps
010225	50	600
010226	70	800



Weldspares has the widest range of 3M™ and Speedglas™ products outside of the 3M™ network.

Call us now on 01925 666198 with your requirements.



# ▶▶ Manual Metal Arc Copper Cable

## Neoprene Rubber Insulated Welding Copper Cable

"Eproflex" black neoprene rubber insulated cable specifically designed for the welding process. Conforms to CEI 20/19/6 IV. ED. 1996+V1: 1999 + V2: 2006 HD 22.6S2 – 1995 + A1 1992 + A2 2004 ; manufactured in accordance with the essential requirements of Low Voltage Directive 73/23 & 93/68 EEC ; therefore authorised to be marked with the designation HO1N2-D <HAR>.

- Superior resistance to heat and flame
- Better mechanical properties
- Specifically intended for use in welding



FUTURIS

Code	mm <sup>2</sup>	Coil
FUTCABEPR25	25	100m
FUTCABEPR35	35	100m
FUTCABEPR50	50	100m
FUTCABEPR70	70	50m

## PVC Single Insulated General Purpose Copper Cable

"Simplex" black PVC single insulated general purpose copper cable.

Conforms to CEI 20-20-III ED. 1990+V1 & V2 1992 ; manufactured in accordance with the essential requirements of Low Voltage Directive 73/23 & 93/68 EEC ; therefore authorised to be marked with the designation HO7VK<HAR>.

- Superior chemical and oil resistance
- First class durability
- Outstanding flexibility



FUTURIS

Code	mm <sup>2</sup>	Coil
010241	16	100m
010242	25	100m
010243	35	100m
010244	50	100m
010245	70	50m
010246	95	50m

## PVC Double Insulated General Purpose Copper Cable

"Duoflex" orange PVC double insulated general purpose copper cable.

Conforms to CEI 20-20-III ED. 1990+V1 & V2 1992 ; manufactured in accordance with the essential requirements of Low Voltage Directive 73/23 & 93/68 EEC ; therefore authorised to be marked with the designation HO7VK<HAR>.

- Superior chemical and oil resistance
- Double insulation
- Greater life expectancy



FUTURIS

Code	mm <sup>2</sup>	Coil
010249	25	100m
010250	35	100m
010251	50	50m



## Full Speedglas range available!



**Speedglas™**

### Earth Clamp Lead Sets

- Complete set containing crocodile earth clamp, cable and Dinze type plug
- Made-up and ready-to-weld



**FUTURIS** 

Code	Plug Size	Cable Size	Amps	Length
010152	10-25mm <sup>2</sup>	25mm <sup>2</sup>	200	5m
010153	35-50mm <sup>2</sup>	35mm <sup>2</sup>	300	5m
010136	35-50mm <sup>2</sup>	35mm <sup>2</sup>	300	10m
010135	35-50mm <sup>2</sup>	50mm <sup>2</sup>	400	3m
010154	35-50mm <sup>2</sup>	50mm <sup>2</sup>	400	5m

### Electrode Holder Lead Sets

- Complete set containing electrode holder, cable and Dinze type plug
- Made-up and ready-to-weld



**FUTURIS** 

Code	Plug Size	Cable Size	Amps	Length
010142	10-25mm <sup>2</sup>	25mm <sup>2</sup>	200	5m
010143	35-50mm <sup>2</sup>	35mm <sup>2</sup>	300	5m
010129	35-50mm <sup>2</sup>	35mm <sup>2</sup>	300	10m
010130	35-50mm <sup>2</sup>	50mm <sup>2</sup>	400	3m
010147	35-50mm <sup>2</sup>	50mm <sup>2</sup>	400	5m

### Extension Lead Sets

- Complete set containing Dinze type socket, cable and Dinze type plug
- Allows extension of an earth clamp or electrode lead set for a greater distance from the machine
- Made-up and ready-to-weld



**FUTURIS** 

Code	Plug/Socket	Cable Size	Amps	Length
010164	35-50mm <sup>2</sup>	35mm <sup>2</sup>	300	5m
010168	35-50mm <sup>2</sup>	35mm <sup>2</sup>	300	10m
010165	35-50mm <sup>2</sup>	35mm <sup>2</sup>	300	15m
010169	35-50mm <sup>2</sup>	50mm <sup>2</sup>	400	10m
010166	35-50mm <sup>2</sup>	50mm <sup>2</sup>	400	15m
010171	35-50mm <sup>2</sup>	50mm <sup>2</sup>	400	20m

**New**

**Buff** 



**EN Certified  
Fire Resistant  
Buff® headwear  
exclusively available  
at Weldspares**



**EN 13637  
Nomex**  

# ▶▶ Manual Metal Arc Electrode Storage

## Stationary Drying Ovens

- Dual voltage 110/240V
- Electrode capacity of 200kg
- Digital temperature controller
- Outer dimensions: L635 x W705 x H725mm
- Inner dimensions: D500 x W430 x H400mm



Inner basket: 4 sections



FUTURIS

Code	Description
FUTOVEN-300	300°C
FUTOVEN-400	400°C

## Portable Drying Oven

- Dual voltage 110/240V
- Electrode capacity of 15kg
- Designed to operate in rugged site conditions
- Thermostatically controlled
- 0-300°C temperature range
- Outer dimensions: W175 x H175 x L585mm
- Inner dimensions: W120 x H110 x L460mm



FUTURIS

Code	Description
101045	Portable Drying Oven

## Quiver - Hammerite

- Dual voltage 110/240V
- Electrode capacity of 9kg
- 120°C maximum temperature
- Essential for maintaining your electrodes moisture-free
- Hammerite protection on case
- Outer dimensions: W120 x H113 x L545mm
- Inner dimensions: W117 x H110 x L460mm



FUTURIS

Code	Description
101020	Hammerite Quiver

## Canisters

Genuine Rod Guard® canister - Airtight storage and inventory control for welding electrodes & filler metals. Original, patented & resealable, remaining the finest quality canister on the market today.

- Airtight - Threaded cap with long-lasting neoprene seal
- High-temperature models - Steel-lined, heat resistant to 107°C
- Reusable - Constructed of high-impact polyethylene
- Available in two lengths - 14" (350mm) & 18" (450mm)
- Can hold up to 4.5kg of electrodes
- Chloride-free
- Quality guaranteed



ROD GUARD

Code	Description
RODRG-100	14" (350mm)
RODRG-200-01	18" (450mm)



### K Type Torches

A selection of torches with versatility and productivity, all designed for operator comfort and available to use with a wide range of gouging carbons (see below).

- Built-in 15° angled-head for demanding metal removal applications
- Inclusive of 360° 2m (7') swivel cable assembly
- Positive grip handle
- Reduced torch and cable weight
- Rugged construction



Code	Description
020000	K3 - 600 Amps
020005	K5 - 1600 Amps
020020	K4000 - 600 Amps

### Flair 2 Type Torch

- Robust design
- Air flow control valve
- Suitable for gouging carbons up to 10mm and applications up to 600 Amps
- 2m (7') swivel cable assembly sold separately



Code	Description
020111	Torch - 600 Amps
020113	2m Swivel Monocable

### Carbon Arc Brazing Torch

Electric brazing torch designed for jobs usually done with an oxy-acetylene torch (welding of thin material, brazing, forging...). Provided with a heatproof anti-splash protection flange, a knob for the feed of the electrode holder rod, as well as a connection cable with fork terminal.

- Can be connected to a normal welding machine with output 50-80A in either AC or DC.
- Must be used with current lower than 50A in AC and 75A in DC
- Comes with 2 x 8mm carbons



Code	Description
010331	Carbon Arc Torch

### Brazing & Gouging Carbons

Brazing carbons to be used with the carbon arc brazing torch (see above) for welding, brazing and heating.



Brazing Carbons			
Code	Dia. x Length	Pack	
010336	8.0 x 250mm	1	

Gouging carbons used for metal removal such as welding defects, excess welds and foundry risers from cast products. Suitable for K and Flair 2 type torches.

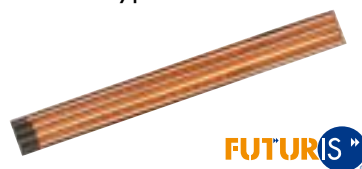

Gouging Carbons		
Code	Dia. x Length	Pack
020131	4.0 x 305mm	100
020132	5.0 x 305mm	50
020133	6.0 x 305mm	50
020134	8.0 x 305mm	50
020135	10.0 x 305mm	50
020136	13.0 x 305mm	50

### Wooden Handle Handscratch Wire Brushes

High-quality handscratch wire brushes

- Beech handle and tempered steel wire
- Non-magnetic stainless steel wire
- Scrape the scale and spatter before brushing



**FUTURIS**

Mild Steel	
Code	Description
FUT010721	2 rows
FUT010722	3 rows
FUT010723	4 rows
FUT010730	4 rows - Scraper
FUTBRMS3ROW	3 rows
FUTBRMS4ROW	4 rows

Stainless Steel	
Code	Description
FUT010725	2 rows
FUT010726	3 rows
FUT010727	4 rows
FUT010729	3 rows - Converging
FUTBRSS3ROW	3 rows
FUTBRSS4ROW	4 rows
FUTBRSSCONV3R	3 rows - Converging
WPWB-15	Toothbrush Style

### Plastic Handle Handscratch Wire Brushes

High-quality plastic handle brushes

- Available in Mild Steel (Red) and Stainless Steel (Green)



**FUTURIS**

Plastic Handle	
Code	Description
FUTBRMSPLHANDLE	Single Row Mild Steel (red)
FUTBRSSPLHANDLE	Single Row Stainless Steel (green)

### Chipping Hammers

Selection of chipping hammers used to remove welding slag. Designed with a double-ended chipping head with a chisel and pointed tip.

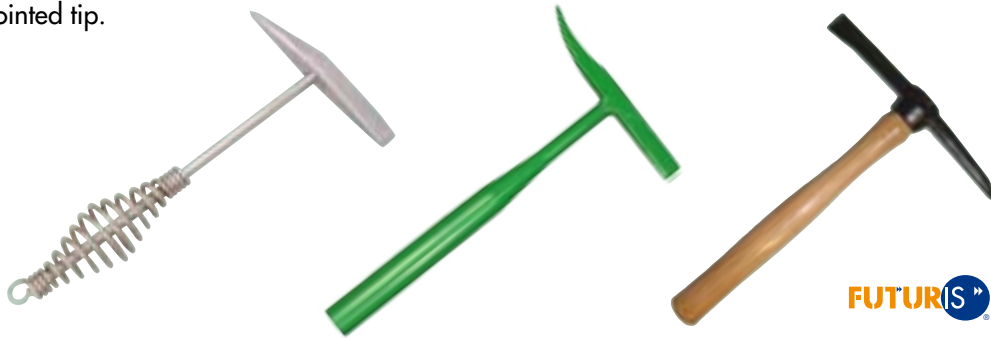

Code	Description
010711	Spring Handle
010712	Tubular Handle
010714	Wooden Handle

### Welders Chipping Blade

Welders Chipping Blade developed for difficult slag removal on steels where high recovery electrodes are being used or flux & metal cored wires

- High speed teeth rip for easy removal of slag
- Gouge point enables access to tricky corners and crevices
- Hardened Bi-Metal Blade & HSS Teeth
- Comfort grip & sabre knuckle protection
- Comes in a handy vinyl pocket case with snap lock and euro slot for point-of-sale display



Code	Description
TA101332	Welders Chipping Blade 32mm

### Welding Gauges

For quick and accurate measuring of weld fillet dimensions and weld preparations in imperial and metric units.

- Excellent for checking alignment and inspection of various angles of welds
- Sizes and numerals are laser etched into the surface for clarity and easier reading
- Deburred blades for fine and smooth edges
- Comes in a handy vinyl pocket case with snap lock and euro slot for point-of-sale display



Code	Description
FUTGAUGE-CAM-8	MG-8 Cam Type
FUTGAUGE-FIL-11	MG-11 Fillet Type

### Magnetic Work Holder

Locates and holds work pieces at different angles while you weld.

- Sets the correct angle, holds it and frees both your hands
- Sets angles of 45°, 90° and 135°
- Strong magnet

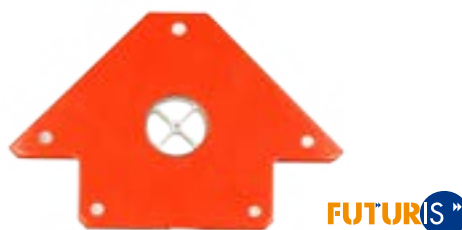

Code	Description
800700	Magnetic Work Holder

# ▶ Manual Metal Arc Electrodes / MMA Rods

## General Purpose

### 51 - E6013

Universal all position mild steel electrode with good operability & easy slag removal. Especially designed for plumbing and piping systems. Suitable for use with low open arc voltage.

Applications: Locksmith trade, metal constructions, tanks...

Code	Dia. x Length	Kg	Code	Dia. x Length	Kg
SEL130040	1.6 x 300mm	4.5	SEL130043	3.2 x 350mm	5
SEL130041	2.0 x 300mm	4	SEL130044	3.2 x 450mm	6.5
SEL130042	2.5 x 350mm	5	SEL130045	4.0 x 350mm	5

### D6 - E6013

Universal mild steel electrode especially designed for vertical downward welding.

Applications: Metal constructions, locksmith trade and maintenance welding.

Code	Dia. x Length	Kg
SEL130025	2.5 x 350mm	5
SEL130026	3.2 x 350mm	5
SEL130027	4.0 x 350mm	5



## Low Hydrogen

### B56 - E7018-1

Universal basic electrode suitable for welding strained parts. Excellent resilience, up to -50°C. Easy slag removal.

Applications: Chassis, heavy structures, shipbuilding...

Code	Dia. x Length	Kg
SEL130072	2.5 x 350mm	5
SEL130068	3.2 x 350mm	5
SEL130069	4.0 x 450mm	6.5



## Stainless Steel

### 20/10 MBC - E316L-16

Rutile-basic stainless steel electrode with a very low humidity pick-up coating. Suitable for welding & cladding austenitic stainless steels (Cr-Ni-Mo type). Excellent corrosion resistance in seawater.

Applications: Chemical/petrochemical industries, shipbuilding, refineries, food industry, pipes, tanks...

Code	Dia. x Length	Kg	Code	Dia. x Length	Kg
SEL100718/A	1.6 x 250mm	1.5	SEL100720/A	2.5 x 300mm	1
SEL100719	2.0 x 300mm	4	SEL100721	3.2 x 350mm	5
SEL100719/A	2.0 x 300mm	1	SEL100721/A	3.2 x 350mm	1
SEL100720	2.5 x 300mm	4	SEL100722/A	4.0 x 350mm	1



## Dissimilar

### 29/9 - E312-16

Rutile-basic stainless steel electrode with an austenitic-ferritic stainless steel deposit. Especially designed for welding dissimilar steels (stainless steels with low alloyed steels) and difficult-to-weld steels. High mechanical properties. Metal deposit highly resistant to cracks, suitable for buffer layers before hardfacing.

Applications: maintenance and repair welding

Code	Dia. x Length	Kg	Code	Dia. x Length	Kg
SEL100715	2.5 x 300mm	4	SEL100716/A	3.2 x 350mm	1
SEL100715/A	2.5 x 300mm	1	SEL100717	4.0 x 350mm	5
SEL100716	3.2 x 350mm	5			



## Hardfacing

### HB60 - E2-UM-60

Rutile-basic coated electrode for hardfacing machine and construction tool parts subject to abrasion due to shocks and pressure. Strong resistance to wear, up to +550°C. Good compromise between abrasion resistance and shock resistance. Compact deposit free from porosity. Soft fusion, low spatters. Suitable for use with low open arc voltage.

Applications: scrapers, chisels, cutting tools, etc...

Code	Dia. x Length	Kg
SEL100740	3.2 x 450mm	6.5
SEL100741	4.0 x 450mm	6.5
SEL100742	5.0 x 450mm	6.5



Selectarc

## Cast Iron

### Fonte-Ni - Ni-CI

Graphite-basic coated electrode with a weld deposit of pure nickel. Recommended for welding and repairing grey cast iron.

Applications: cracks, engine blocks, machine frames, gearboxes...

Code	Dia. x Length	Kg	Code	Dia. x Length	Kg
SEL100710	2.5 x 350mm	5	SEL100711/A	3.2 x 350mm	1
SEL100710/A	2.5 x 350mm	1	SEL100712	4.0 x 350mm	5
SEL100711	3.2 x 350mm	5	SEL100712/A	4.0 x 350mm	1



Selectarc

## Chamfering / Cutting / Gouging

### DCS

Electrode for chamfering, cutting, grooving and gouging all metals including stainless steels, cast iron and Cu alloys. Strong blowing characteristic to remove metal with high efficiency. Smooth and uniform cut with a slight carbide surface.

Applications: Chamfering of steels & cast iron..., removal of screws, rivets & welding beads..., chamfering of foundry defects or cracks before repair welding, chamfering of hardfacing deposits or tempered steels.

Code	Dia. x Length	Kg
SEL100751	3.2 x 350mm	4
SEL100752	4.0 x 450mm	5



Selectarc

## D.I.Y. Mini-Pack Electrodes

Compact point-of-sale display rod packets, saving the need to buy full cartons for small jobs.

General Purpose E6013		Low Hydrogen E7018-1		Stainless Steel E316L-16		Dissimilar E312-16		Cast Iron Ni-CI	
Code	Dia. x Length	Code	Dia. x Length	Code	Dia. x Length	Code	Dia. x Length	Code	Dia. x Length
FUT100810	1.6 x 300mm	FUT100822	2.5 x 350mm	FUT100830	1.6 x 250mm	FUT100842	2.5 x 300mm	FUT100852	2.5 x 350mm
FUT100811	2.0 x 300mm	FUT100823	3.2 x 350mm	FUT100831	2.0 x 300mm	FUT100843	3.2 x 350mm	FUT100853	3.2 x 350mm
FUT100812	2.5 x 350mm			FUT100832	2.5 x 300mm				
FUT100813	3.2 x 350mm			FUT100833	3.2 x 350mm				
FUT100814	4.0 x 350mm								



FUTURIS



# Gas Equipment ▶▶

Welding & Cutting Kits	20-21
Cutting Machines	22
Cutting Guides	23
Nozzle Mix Cutting Torches	24-25
Type III/HD Cutting, Welding & Heating Torch	26-27
Lightweight Cutting & Welding Torch	28-29
Cutting & Gouging Nozzles	30-31
Welding Nozzles	32
Heating Nozzles	33
Single Stage Gas Regulators	34
Multi-Stage Gas Regulators	35
Gas Control Devices	36
Gas Spares	37
Welding Hose	38-39
Hose Fittings	40-42
Spark Lighters	43
General Gas Tools	44
Standard Cylinder Trolleys	45-47
Heavy Duty Cylinder Trolleys	48
Site Cylinder Trolleys / Pneumatic Wheels	49

# ▶ Gas Equipment Welding & Cutting Kits

## Oxygen/Acetylene Cutting Kit



An oxygen & acetylene cutting kit capable of cutting up to 300mm (12")

Components:

- 18" - 90° Nozzle Mix Cutting Blowpipe
- Single Stage 10bar/150psi Oxygen Plugged Regulator
- Single Stage 1.5bar/22.5psi Acetylene Plugged Regulator
- 5m Hose Set with HSCV
- Oxygen Thermal In-Line Flashback Arrestor
- Fuel Gas Thermal In-Line Flashback Arrestor
- ANM Short Nozzles
- Nozzle Cleaners
- Cup Type Spark Lighter
- Drop Forged Combination Spanner
- Cup Goggle 2" Round Shade 5 - EN166 & EN175



Code	Description
FUTKIT18/90-OA	Oxygen/Acetylene Cutting Kit

## Oxygen/Propane Cutting Kit



An oxygen & propane cutting kit capable of cutting up to 300mm (12")

Components:

- 18" - 90° Nozzle Mix Cutting Blowpipe
- Single Stage 10bar/150psi Oxygen Plugged Regulator
- Single Stage 4bar/58psi Propane Plugged Regulator
- 5m Hose Set with HSCV
- Oxygen Thermal In-Line Flashback Arrestor
- Fuel Gas Thermal In-Line Flashback Arrestor
- PNM Short Nozzles
- Nozzle Cleaners
- Cup Type Spark Lighter
- Drop Forged Combination Spanner
- Cup Goggle 2" Round Shade 5 - EN166 & EN175



Code	Description
FUTKIT18/90-OP	Oxygen/Propane Cutting Kit

## Type III/HD Welding & Cutting Kits



A general purpose cutting & welding kit capable of cutting up to 150mm (6") and welding 30mm (1 1/4").

Components:

- Type III/HD Welding, Cutting & Heating Shank
- Type III/HD Welding & Heating Mixer
- Type III/HD Cutting Attachment
- Single Stage 10bar/150psi Oxygen Plugged Regulator
- Single Stage 1.5bar/22.5psi Acetylene Plugged Regulator
- 5m Hose Set with HSCV
- Oxygen Thermal In-Line Flashback Arrestor
- Fuel Gas Thermal In-Line Flashback Arrestor
- Type III/HD Swaged Welding Nozzles
- ANM Short Nozzles
- Nozzle Cleaners
- Cup Type Spark Lighter
- Drop Forged Combination Spanner
- Cup Goggle 2" Round Shade 5 - EN166 & EN175



Code	Description
FUTKITTYPE23-OA	Type 2/3/4 Welding & Cutting Kit Oxygen / Acetylene
FUTKITTYPE23-OP	Type 2/3/4 Welding & Cutting Kit Oxygen / Propane

## Lightweight Welding & Cutting Kit



FUTURIS™

A lightweight cutting & welding kit suitable for the DIY user and the professional gas welding market.

Components:

- Lightweight Welding & Cutting Shank
- Lightweight Welding Mixer
- Lightweight Cutting Attachment
- Lightweight Swaged Welding Nozzles
- AFNM Nozzles
- AFN Nozzle
- Nozzle Cleaners
- Single Stage 2 Gauge 10bar/150psi Oxygen Regulator
- Single Stage 2 Gauge 1.5bar/22.5psi Acetylene Regulator
- Oxygen Thermal In-Line Flashback Arrestor
- Fuel Gas Thermal In-Line Flashback Arrestor
- 5m Hose Set with HSCV
- Cup Type Spark Lighter
- Drop Forged Combination Spanner
- Cup Goggle 2" Round Shade 5 - EN166 & EN175

Code	Description
FUTKITL/W-OA	Lightweight Welding & Cutting Kit Oxygen / Acetylene

## Model O Kit



FUTURIS™

A high precision instrument for delicate welding and heating work up to 1.5mm

- Used in a wide range of fine heating and welding applications including dentistry, jewellery, electronics and lead welding
- The injector capability allows the blowpipe to be used with acetylene or hydrogen fuel gases

Components:

- Model O Blowpipe with Neck
- Model O Welding Nozzles
- Blowpipe & Nozzle Spanner
- Plastic Carry Case

Code	Description
040434	Model O Kit
040440	Model O Blowpipe

## Model O Blowpipe Accessories

Replacement neck for Model O Blowpipe .



FUTURIS™

Code	Description
040455	Model O Threaded Neck

High precision welding nozzles for use with the Model O Blowpipe (040440) and neck (040455).



FUTURIS™

Code	Description
040353	Model O #1
040354	Model O #2
040355	Model O #3
040356	Model O #4
040357	Model O #5



## Straight Profile Cutting Machine

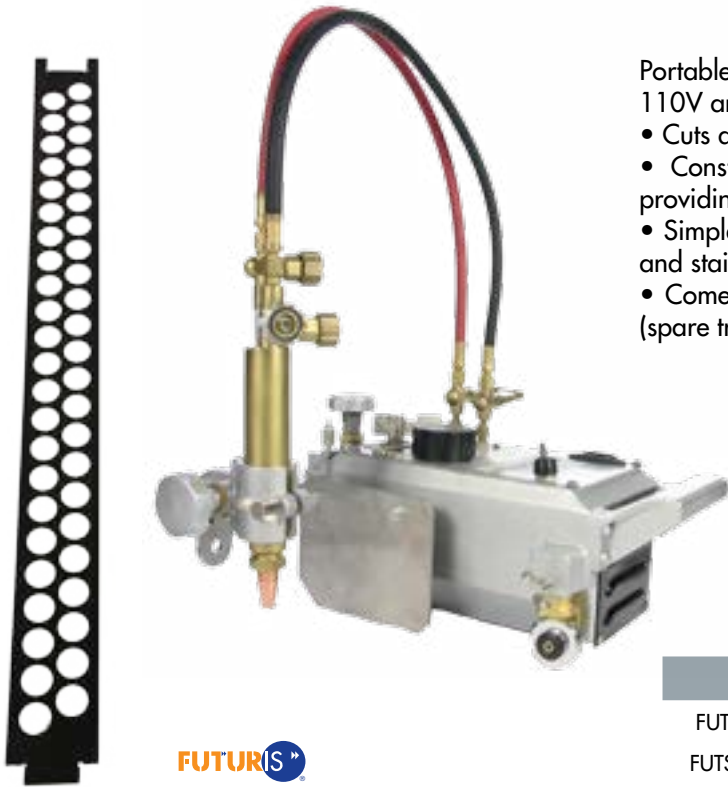

Portable automatic straight-line cutting machine available in 110V and 220V versions.

- Cuts and bevels on 5mm-50mm thick steel.
- Constant adjustable cutting speed (forward/reverse) thus providing good quality cuts.
- Simple design, robust and compact manufacture using brass and stainless steel components.
- Comes with nozzles and a 1.8m distortion-proof steel track (spare tracks also available to add on extra length).

Code	Description
FUTSTRAIGHTCUT	Profile Cutting Machine Straight 110V
FUTSTRAIGHTCUT2	Profile Cutting Machine Straight 220V
FUTSTRAIGHTTRAK	Spare Track for Straight Profile Cutting Machine

## Rotary Pipe Cutting Machine



Manual chain-driven pipe cutting machine.

- Provides smooth and accurate cutting action by incorporating a low gear ratio and worm wheel drive.
- Cuts 5-50mm thick wall on pipe with 102-600mm (4-24") diameter.
- Beveling head angle can be set quickly and accurately by scale on a rack and pinion.
- Robust and compact manufacture using brass, chromed and stainless steel components.
- Comes with nozzles and a 2.4m guide chain.

Code	Description
FUTPIPE-CUTTER	Rotary Pipe Cutting Machine - Hand Drive
FUTPIPE-CUT-TRK	Spare Guide Chain for Rotary Pipe Cutting Machine

## Tanjan Circle Cutting Guide



This Tanjan circle cutting guide allows circles to be cut from one position by turning the guide frame.

- High quality machined parts allowing for accurate cutting with NM series and Type III/HD cutters.
- Cuts circles 25mm to 700mm in diameter.
- Optimum tip height at all times.
- Stainless steel axles and rails.

Code	Description
TJ1082	Tanjan Circle Cutting Guide (ANM/PNM)

## Tanjan Roller Cutting Guide



High quality machined parts allowing for accurate cutting with NM series and Type III/HD cutters.

- Optimum tip height at all times.
- Non-jamming hub design.
- Stainless steel axles & guards.
- No tools required for fitting.

Code	Description
TJ1602	Tanjan Roller Cutting Guide (ANM/PNM)

## Futuris Circle Cutting Guide - Large



Attaches directly to the nozzle of the NM series cutters allowing a controlled circular cut of ~750mm diameter.

Code	Description
FUTCIRC-LARGE	Futuris Circle Cutting Guide - Large

## Futuris Circle Cutting Guide - Small



Attaches to the pipes of the NM series cutters allowing a controlled circular cut of smaller diameter circles by pivoting around the centre-punched guide hole.

Code	Description
FUTCIRC-SMALL	Futuris Circle Cutting Guide - Small

# ▶▶ Gas Equipment

## Nozzle Mix Cutting Torches

### 18" 90° Nozzle Mix Cutting Torch

18" 90° - NM250 Style oxygen/fuel gas cutting torch used with NM type nozzles.

- The 18" - 457mm handle and 90° cutting head is the most common size and configuration of oxygen/fuel gas cutting torches.
- The oxygen and fuel gases mix in the nozzle to cut steels up to 12" - 300mm thick.
- 3/8" BSP gas connections.

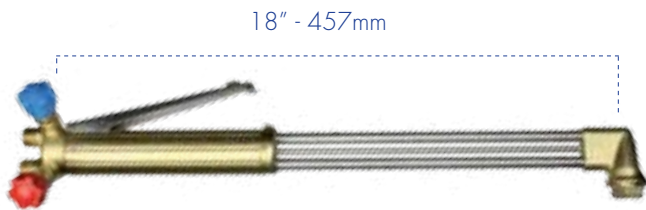

FUTURIS™

Code	Description
040411	18" 90°

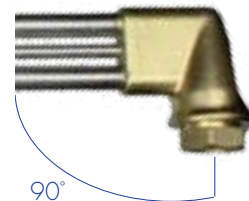

### 18" 180° Nozzle Mix Cutting Torch

Straight 180° oxygen/fuel gas cutting torch used with NM type nozzles.

- Standard 18" - 457mm handle.
- The oxygen and fuel gases mix in the nozzle to cut steels up to 12" - 300mm thick.
- 3/8" BSP gas connections.

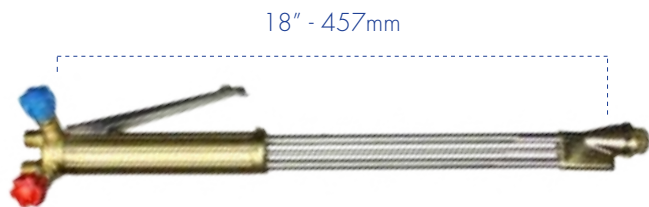

FUTURIS™

Code	Description
040415	18" 180°

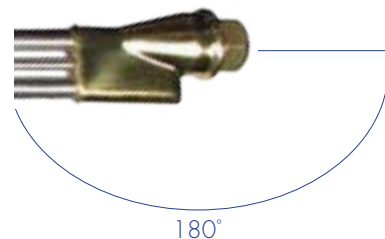

### 27" 75°/105° Nozzle Mix Cutting Torch

The extended 27" - 686mm handle and 75°/105° cutting head allow greater reach into difficult areas and increase distance from the cutting heat.

- Oxygen/fuel gas cutting torch used with NM type nozzles.
- The oxygen and fuel gases mix in the nozzle to cut steels up to 12" - 300mm thick.
- 3/8" BSP gas connections.

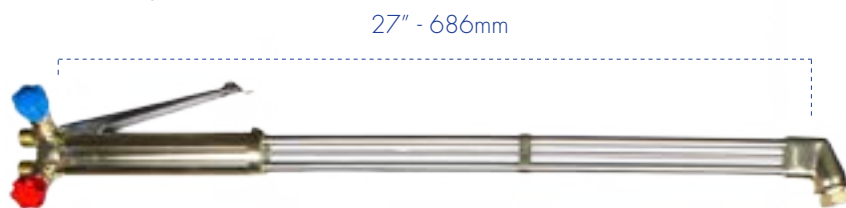

FUTURIS™

Code	Description
040413	27" 75°/105°

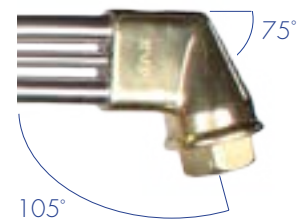



## 36" 75°/105° Nozzle Mix Cutting Torch

The further extended 36" - 914mm handle and 75°/105° cutting head allow even greater reach into difficult areas.

- Oxygen/fuel gas cutting torch used with NM type nozzles.
- The oxygen and fuel gases mix in the nozzle to cut steels up to 12" - 300mm thick.
- 3/8" BSP gas connections.

36" - 914mm

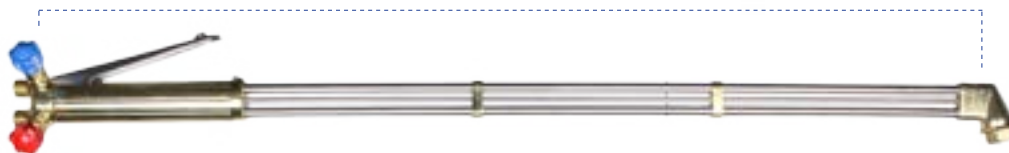

Code	Description
040404	36" 75°/105°

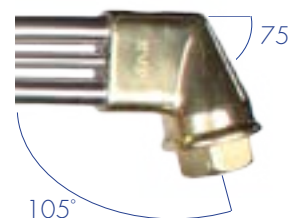

## 36" 90° Nozzle Mix Cutting Torch

A 36" - 914mm extended handle on the standard 90° cutting head for greater reach into difficult areas and maximum distance from the cutting heat.

- Oxygen/fuel gas cutting torch used with NM type nozzles.
- The oxygen and fuel gases mix in the nozzle to cut steels up to 12" - 300mm thick.
- 3/8" BSP gas connections.

36" - 914mm



Code	Description
040410	36" 90°

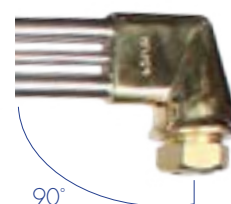

## 36" 180° Nozzle Mix Cutting Torch

A straight 180° cutting head on extended 36" - 914mm handle for greater reach and maximum distance from the cutting heat.

- Oxygen/fuel gas cutting torch used with NM type nozzles.
- The oxygen and fuel gases mix in the nozzle to cut steels up to 12" - 300mm thick.
- 3/8" BSP gas connections.

36" - 914mm



Code	Description
040407	36" 180°

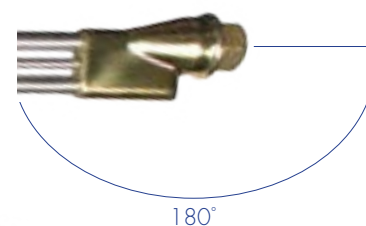

# ▶ Gas Equipment

## Type III/HD Cutting, Welding & Heating Torch

### CUTTING

Nozzle Mix (NM) Cutting Nozzles  
See page 30 & page 31

Sheet Metal Cutting Nozzles  
See page 30

AGNM/PGNM Nozzles  
See page 30 & page 31

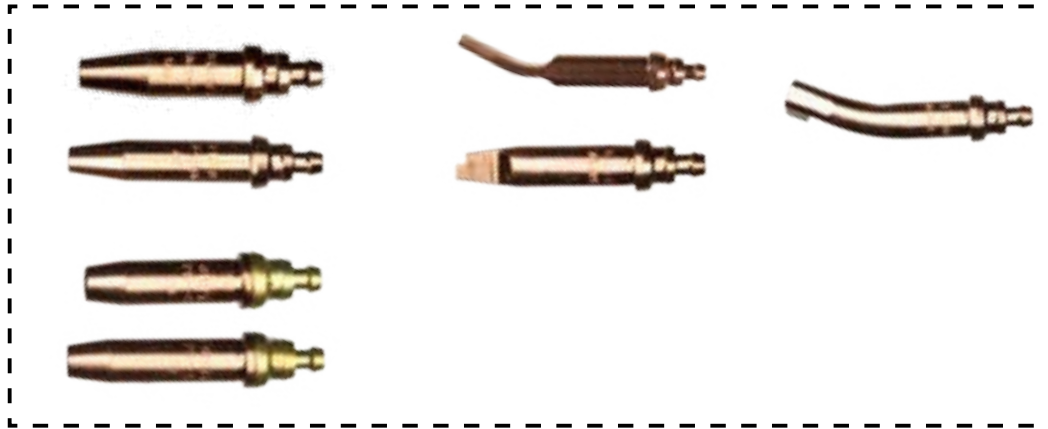

040423  
Propane/Acetylene  
Cutting Attachment

### WELDING



FUTNOZ-235-...  
Acetylene Welding Nozzles  
See page 32



040422  
Acetylene  
Welding & Heating  
Mixer

### ACETYLENE HEATING



04017-...  
Acetylene Heating Nozzles (AHT)  
See page 33



040432  
Acetylene Heating Neck

### PROPANE HEATING



04037-...  
Propane Heating Nozzles  
See page 33



040424  
270mm Propane Heating Neck



040426  
700mm Propane Heating Neck



040425  
Propane  
Heating Mixer



040421  
Welding, Cutting  
& Heating Shank

### Type III/HD Welding, Cutting & Heating Shank

Type III/HD shank to control the flow of the oxygen and fuel gases through either the Type III/HD welding & heating mixers or the Type III/HD cutting attachment.



Code	Description
040421	Type III/HD Welding, Cutting & Heating Shank

### Type III/HD Cutting Attachment

Attaches to the Type III/HD oxygen/fuel gas shank to cut using ANM, PNM, ASNM & AGNM nozzles (see page 30 & page 31).

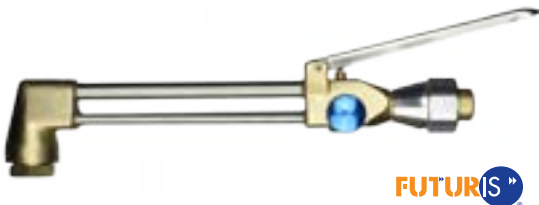

Code	Description
040423	Type III/HD Cutting Attachment

### Type III/HD Welding & Heating Mixers

Attaches to the Type III/HD oxygen/fuel gas shank to weld using Type III/HD series nozzles (FUTNOZ-235... on page 32), or to heat using AHT series nozzles (04017... on page 33) with the acetylene bent neck (040432).



Code	Description
040422	Acetylene Welding & Heating Mixer

Attaches to the Type III/HD oxygen/fuel gas shank to heat using H series nozzles (04037... on page 33) when used with either a 270mm or 700m superheating neck (040424 & 040426).



Code	Description
040425	Propane Heating Mixer

### Type III/HD Heating Necks

Brass heating neck used with the acetylene welding & heating mixer (040422) and the AHT series acetylene heating nozzles (04017... on page 33).



Code	Description
040432	Acetylene Heating Neck

Used with the propane heating mixer (040425) and the H series propane heating nozzles (04037... on page 33). Stainless and available in two lengths for heating large areas of metal.



Code	Description
040424	270mm Propane Heating Neck
040426	700mm Propane Heating Neck

# ▶ Gas Equipment Lightweight Cutting & Welding Torch

## CUTTING

AFN & AFNM Cutting Nozzles  
See page 30

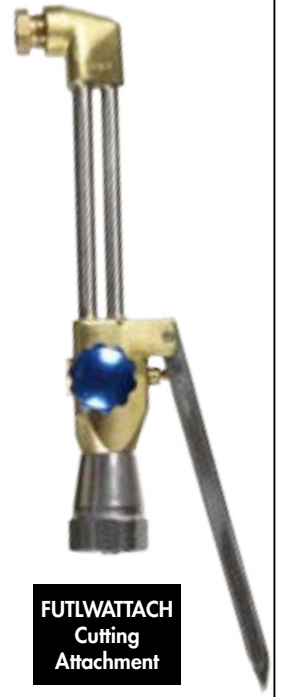
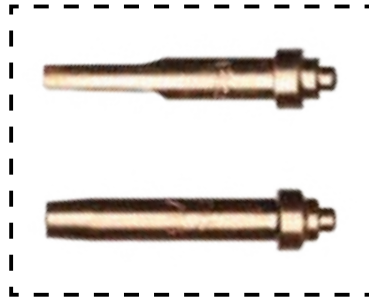

FUTLWATTACH  
Cutting  
Attachment

## WELDING

FUTNOZ-LW-...  
Lightweight Welding Nozzles  
See page 32



FUTLWMIXER  
Mixer



04031...  
DH Welding Nozzles  
See page 32

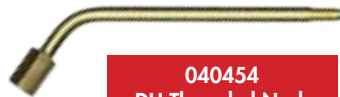

040454  
DH Threaded Neck



FUTLWSHANK  
Welding &  
Cutting Shank

### Lightweight Welding & Cutting Shank

Lightweight welding & cutting shank to control the flow of the oxygen and fuel gases through either the Lightweight welding mixer (040402) or the Lightweight cutting attachment (040403).



Code	Description
FUTLWSHANK	Lightweight Welding & Cutting Shank

### Lightweight Cutting Attachment

Attaches to the Lightweight oxygen/fuel gas shank to cut using AFNM (FUTNOZ-AFNM on page 30) & AFN nozzles (040113 on page 30).



Code	Description
FUTLWATTACH	Lightweight Cutting Attachment

### Lightweight Welding Mixer

Attaches to the Lightweight oxygen/fuel gas shank to weld using Lightweight series nozzles (FUTNOZ-LW-... on page 32), DH series nozzles (04031... on page 32) with the DH threaded neck.



Code	Description
FUTLWMIXER	Lightweight Welding Mixer

### DH Threaded Neck

Converts the Lightweight welding mixer (040402) to use DH series welding nozzles (04031... on page 32).



Code	Description
040454	DH Threaded Neck



# ▶ Gas Equipment Cutting & Gouging Nozzles

## ANM - Acetylene Nozzle Mix Cutting Nozzles

ANM Short and Long/Extended nozzles for use in oxygen-acetylene cutting with NM series cutters or the type III/HD cutting attachment (040423).



Code	Description
040121	ANM Short 1/32"
040122	ANM Short 3/64"
040123	ANM Short 1/16"
040124	ANM Short 5/64"
040125	ANM Short 3/32"
040126	ANM Short 7/64"
040127	ANM Short 1/8"



Code	Description
040131	ANM Long 1/32"
040132	ANM Long 3/64"
040133	ANM Long 1/16"
040134	ANM Long 5/64"
040135	ANM Long 3/32"
040136	ANM Long 7/64"
040137	ANM Long 1/8"

## Acetylene Sheet Metal Cutting Nozzles

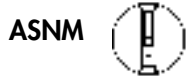

**ASNM**

Used with the type III/HD cutting attachment (040423) to cut sheet metal.

FUTNOZ-ASNM



**ARCNM**  
Rivet Head Removal

Used with NM series cutters and the type III/HD cutting attachment (040423) to remove rivet heads.

FUTNOZ-ARCNM



**AFN**

Used with the Lightweight cutting attachment (040403) to cut sheet metal.

040113



## AFNM Cutting Nozzles

Acetylene cutting nozzles for use with the Lightweight cutting attachment (040403).  
3 sizes to cut: 3-6mm, 6-20mm & 20-50mm.



Code	Description
FUTNOZ-AFNM1/16	AFNM 1/16" - 3-6mm
FUTNOZ-AFNM1/32	AFNM 1/32" - 6-20mm
FUTNOZ-AFNM3/64	AFNM 3/64" - 20-50mm

## AGNM Gouging Nozzles

Acetylene gouging nozzles for use with the type III/HD cutting attachment (040423) or NM series cutters.  
3 sizes to gouge: 6-8mm, 8-11mm & 10-13mm.



Code	Description
FUTNOZ-AGNM-13	AGNM #13 - 6-8mm
FUTNOZ-AGNM-19	AGNM #19 - 8-11mm
FUTNOZ-AGNM-25	AGNM #25 - 10-13mm

## PNM - Propane Nozzle Mix Cutting Nozzles

PNM Short and Long/Extended nozzles for use in oxygen-propane cutting with NM series cutters or the type III/HD cutting attachment (040423).



Code	Description
040141	PNM Short 1/32"
040142	PNM Short 3/64"
040143	PNM Short 1/16"
040144	PNM Short 5/64"
040145	PNM Short 3/32"
040146	PNM Short 7/64"
040147	PNM Short 1/8"



Code	Description
040151	PNM Long 1/32"
040152	PNM Long 3/64"
040153	PNM Long 1/16"
040154	PNM Long 5/64"
040155	PNM Long 3/32"
040156	PNM Long 7/64"
040157	PNM Long 1/8"

## PGNM Gouging Nozzles

Propane gouging nozzles for use with the type III/HD cutting attachment (040423) or NM series cutters. 4 sizes to gouge : 3-6mm, 5-9mm, 6-12mm & 10-16mm



FUTURIS

Code	Description
FUTNOZ-PGNM-1	PGNM #1 - 3-6mm
FUTNOZ-PGNM-2	PGNM #2 - 5-9mm
FUTNOZ-PGNM-3	PGNM #3 - 6-12mm
FUTNOZ-PGNM-4	PGNM #4 - 10-16mm

## NFF Cutting Nozzles

Propane cutting nozzles used with 62 Style flat seat injector torches.



Code	Description	Code	Description
040211	NFF 0	040215	NFF 4
040212	NFF 1	040216	NFF 5
040213	NFF 2	040217	NFF 6
040214	NFF 3		

## VVC Cutting Nozzles

Chrome plated propane cutting nozzles used with machine profile cutters and 62 Style flatseat injector torches



Code	Description	Code	Description
040180	VVC 5/0	040189	VVC 2
040181	VVC 4/0	040190	VVC 2 1/2
040183	VVC 00	040191	VVC 3
040184	VVC 0	040192	VVC 4
040185	VVC 0 1/2	040193	VVC 5
040186	VVC 1	040194	VVC 000
040188	VVC 1 1/2	040195	VVC 5 1/2

# ▶ Gas Equipment Welding Nozzles

## Type III/HD Welding Nozzles

Acetylene swaged welding nozzles for use with the type III/HD mixer (040422) and shank (040421).



Code	Description	Code	Description
FUTNOZ-235-1	Type III/HD #1	FUTNOZ-235-10	Type III/HD #10
FUTNOZ-235-2	Type III/HD #2	FUTNOZ-235-13	Type III/HD #13
FUTNOZ-235-3	Type III/HD #3	FUTNOZ-235-18	Type III/HD #18
FUTNOZ-235-5	Type III/HD #5	FUTNOZ-235-25	Type III/HD #25
FUTNOZ-235-7	Type III/HD #7	FUTNOZ-235-35	Type III/HD #35

## Lightweight Welding Nozzles

Acetylene swaged welding nozzles for use with the Lightweight welding mixer (040402) and shank (040401).

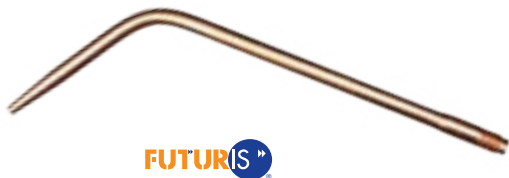

Code	Description	Code	Description
FUTNOZ-LW-1	Lightweight #1	FUTNOZ-LW-10	Lightweight #10
FUTNOZ-LW-2	Lightweight #2	FUTNOZ-LW-13	Lightweight #13
FUTNOZ-LW-3	Lightweight #3	FUTNOZ-LW-18	Lightweight #18
FUTNOZ-LW-5	Lightweight #5	FUTNOZ-LW-25	Lightweight #25
FUTNOZ-LW-7	Lightweight #7		

## DH Welding Nozzles

Precision acetylene welding nozzles for use with the Lightweight welding mixer (040402), the DH neck (040454) and shank (040401).



Code	Description	Code	Description
040311	DH #1	040316	DH #10
040312	DH #2	040317	DH #13
040313	DH #3	040318	DH #18
040314	DH #5	040319	DH #25
040315	DH #7		

## Model O Welding Nozzles

High precision welding nozzles for use with the Model O Blowpipe (040440) and neck (040455).



Code	Description
040353	Model O #1
040354	Model O #2
040355	Model O #3
040356	Model O #4
040357	Model O #5

## Propane Heating Nozzles

Propane H type heating nozzles with castellated head used for heating large areas with the type III/HD propane mixer (040425) and necks (040424, 040426) or NM series cutters with heating NM nozzle adaptor (040427).



FUTURIS™

Code	Description
040371	1H
040372	2H
040373	3H
040374	4H
040375	5H

## NM Heating Nozzle Adaptor

Converts a standard Nozzle Mix cutter to use propane superheating nozzles (see above).



FUTURIS™

Code	Description
040427	NM Heating Nozzle Adaptor

## Acetylene Heating Nozzles

Acetylene AHT heating nozzles used with acetylene heating neck (040432).



FUTURIS™

Code	Description
040170	AHT 25
040171	AHT 50
040172	AHT 100

## Propane Heating NM Nozzle

Pepper pot style heating nozzle for use with the type III/HD cutting attachment (040423) or NM series cutters.

- Screws directly into the torch in place of the headnut when using with NM series cutters.
- Consumable insert can be easily replaced with the pepper pot consumable insert.



FUTURIS™

Code	Description
FUTNOZ-PHNM	PHNM Propane Heating Nozzle
FUTNOZ-PHNM-INS	Insert for PHNM Propane Heating Nozzle

# ▶▶ Gas Equipment

## Single Stage Gas Regulators

### Oxygen, Acetylene, CO<sub>2</sub> & Argon



FUTURIS™

EN ISO2503

A quality range of economical single stage regulators covering a wide range of applications including welding, cutting, heating and inert gas supply.

- Available with 2 gauges: one to show bottle pressure and one for outlet pressure, or in simpler 1 gauge configuration to show only bottle pressure.
- Manufactured to EN ISO2503.

The Argon Pre-set regulator is to be used with a flowmeter attached for MIG & TIG shielding gases to set a fixed flow rate.

Code	Gas	Outlet Pressure	Outlet Connection	Gauges
FUTREG1SOXY-2G	Oxygen	10bar - 150psi	G 3/8"	2
FUTREG1SACE-2G	Acetylene	1.5bar - 22.5psi	G 3/8" LH	2
FUTREG1SCO2-2G	CO <sub>2</sub>	5bar - 72psi	G 3/8"	2
FUTREG1SARG-2GM	Argon	3.5bar - 29psi 40L/min		2
FUTREG1SARG-2GT	Argon	0-10 Bar - 150psi		2
FUTREG1SARG-1G	Argon	2bar - 29psi   40L/min	G 3/8"	1
FUTREG1SARG-PS	Argon	2bar - 29psi   Pre-set	G 3/8"	1
FUTREG1SNIT-2G	Nitrogen	4bar - 58psi	G 3/8"	1

### Oxygen, Acetylene & Propane - Gaugeless / Plugged



FUTURIS™

EN ISO2503

Gaugeless / plugged versions of our economical range of quality single stage regulators covering welding, cutting and heating applications.

- Often used on-site where there is a risk of accidental damage to gauges and where fine adjustment of outlet pressures is not always necessary.
- Manufactured to EN ISO2503.

Code	Gas	Outlet Pressure	Outlet Connection	Gauges
FUTREG1SOXY-PL	Oxygen	10bar - 150psi	G 3/8"	0
FUTREG1SACE-PL	Acetylene	1.5bar - 22.5psi	G 3/8" LH	0
FUTREG1SPRO-PL	Propane	4bar - 58psi	G 3/8" LH	0

### Nitrogen Refrigeration Outlet Regulator



ECE

Specifically designed to meet the needs of the heating, ventilation and air conditioning (HVAC) trades for purge and leak test applications.

- Supplied with JIC outlet fittings.
- 300bar inlet pressure.

Code	Gas	Outlet Pressure	Inlet Connection	Outlet Connection	Gauges
FUTREGNIT-REFRI	Nitrogen	52bar	G 5/8"	W 11x1.25	2

### Oxygen, Acetylene, Argon & Nitrogen



EN ISO2503

Precision manufactured regulators designed to give a much more accurate and constant gas delivery than single stage regulators.

- Cover a wide range of applications including welding, cutting, heating and inert gas where a constant flow rate is required without the need to re-adjust the regulator output.
- 2 gauges: one to show bottle pressure and one for outlet pressure.
- Manufactured to EN ISO2503.

Code	Gas	Outlet Pressure	Outlet Connection	Gauges
FUTREG2SOXY2G	Oxygen	5bar - 72psi	G 3/8"	2
FUTREG2SOXY2G10	Oxygen	10bar - 150psi	G 3/8"	2
FUTREG2SACE2G	Acetylene	1.5bar - 22.5psi	G 3/8" LH	2
FUTREG2SARG2G	Argon	5bar - 72psi	G 3/8"	2
FUTREG2SARG2G10	Argon	10bar - 150psi	G 3/8"	2
FUTREG2SNIT2G10	Nitrogen	10bar - 150psi	G 3/8"	2
FUTREG-2SHYD2G	Hydrogen	10bar - 150psi	G 3/8"	2

### Flowmeters

Attach to the outlet of inert gas regulators to give greater control of the shielding gas when TIG or MIG welding. Can be used in conjunction with Argon Preset regulator. Available in two versions: 0-14L/min and 0-30L/min.



0-30L/min usually intended for MIG welding applications

Code	Description
040564	0-30L/min

FUTURIS



0-14L/min usually intended for TIG welding applications

Code	Description
040563	0-14L/min

FUTURIS

### Balloon Inflator



FUTURIS

Specially designed as a balloon filler for parties and functions.

- Rubber tilt valve for easy of use.

Code	Description
FUTREG-BALLOON	Balloon Inflator

### Gas Flow Indicator

Also known as peashooter. Place over the end of a MIG or TIG torch to indicate the flow level of the shielding gas.



**FUTURIS**

Code	Description
FUTFLOW-IND	Gas Flow Indicator

### Gas Economiser

Allows the gas torch to be held on the hooked arm when not in use which shuts off gas supply to the torch. When unhooked, the torch can be immediately re-ignited from the pilot light without having to re-adjust the valves.

- Can save up to 50% gas wastage.
- 3/8" BSP fittings.



**FUTURIS**

Code	Description
040530	Oxygen/Fuel Gas Economiser 3/8" BSP 10mm

### CO<sub>2</sub> Heater

Heats the CO<sub>2</sub> gas as it passes through to help prevent freezing in any of the down line equipment.



**FUTURIS**

Code	Description
FUTCO2-HEATER	CO <sub>2</sub> Gas Heater - 220V

**FF** MIG series



**FF** TIG series

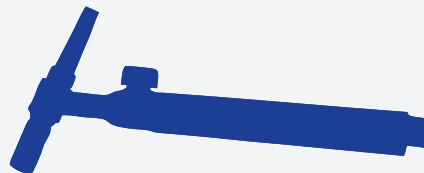

**FF** PLA series

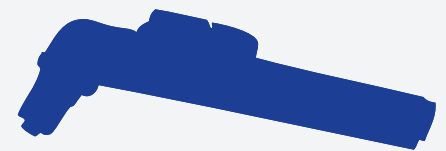

### Bottle Stems

Replacement regulator bottle stem with sintered filter. The stem can become worn over time through regular use causing leaks to occur.



Code	Description
030212	Bottle Stem - 1/2" 27 TPI Assembled
030213	Bottle Stem - 1/4" BSP Assembled

### Cylinder Nuts

Replacement regulator or cylinder nut. The nut can become worn over time through general use.



Code	Description
030231	Cylinder Nut - RH
030232	Cylinder Nut - LH

### Regulator Adaptors

The extended right-angle adaptor allows a standard regulator to be used on a cylinder with a side entry connector.

- Turns the connector 90° to bring the regulator vertical.

The extended straight version is a simple straight extension to a cylinder to raise the height of the outlet to connect the regulator.

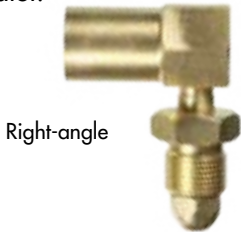

Code	Description
FUT040245	Regulator Adaptor Ext. Right Angle 5/8" BSP RH
FUT040246	Regulator Adaptor Ext. Right Angle 5/8" BSP LH
FUT040247	Regulator Adaptor Ext. Straight 5/8" BSP RH
FUT040248	Regulator Adaptor Ext. Straight 5/8" BSP LH

### Nozzle Mix Blowpipe Headnut

Replacement headnut for NM series cutting torches/blowpipes when the original is damaged or lost during regular nozzle changes.



Code	Description
FUTHEADNUT	Blowpipe Headnut



### Fitted Hose

High quality EN ISO3821:2010 certified hose lengths, pre-fitted with EN 730-2 certified double safety check valves, nuts & tails.

- Leak tested to EN1256:2006.
- Highly resistant to kinks and abrasion.
- Available in 5, 10, 20m and 30m lengths for oxygen, acetylene and propane gases, with a wide range of bore and fitting sizes.
- Supplied as single line. Order 1 x Oxygen and 1 x Fuel gas for set.

Code	Gas	Hose Diam. (mm)	Fittings	Check Valve	Length
040704B	Oxygen	6	3/8"	3/8"	5m
040711B	Oxygen	6	3/8"	1/4"	5m
040717B	Oxygen	8	3/8"	3/8"	5m
040714B	Oxygen	10	3/8"	3/8"	5m
040704R	Acetylene	6	3/8"	3/8"	5m
040711R	Acetylene	6	3/8"	1/4"	5m
040717R	Acetylene	8	3/8"	3/8"	5m
040714R	Acetylene	10	3/8"	3/8"	5m
040704P	Propane	6	3/8"	3/8"	5m
040711P	Propane	6	3/8"	1/4"	5m
040717P	Propane	8	3/8"	3/8"	5m
040714P	Propane	10	3/8"	3/8"	5m

Code	Gas	Hose Diam. (mm)	Fittings	Check Valve	Length
040706B	Oxygen	6	3/8"	3/8"	20m
040713B	Oxygen	6	3/8"	1/4"	20m
040719B	Oxygen	8	3/8"	3/8"	20m
040716B	Oxygen	10	3/8"	3/8"	20m
040706R	Acetylene	6	3/8"	3/8"	20m
040713R	Acetylene	6	3/8"	1/4"	20m
040719R	Acetylene	8	3/8"	3/8"	20m
040716R	Acetylene	10	3/8"	3/8"	20m
040706P	Propane	6	3/8"	3/8"	20m
040719P	Propane	8	3/8"	3/8"	20m
040716P	Propane	10	3/8"	3/8"	20m

Code	Gas	Hose Diam. (mm)	Fittings	Check Valve	Length
040705B	Oxygen	6	3/8"	3/8"	10m
040712B	Oxygen	6	3/8"	1/4"	10m
040718B	Oxygen	8	3/8"	3/8"	10m
040715B	Oxygen	10	3/8"	3/8"	10m
040705R	Acetylene	6	3/8"	3/8"	10m
040712R	Acetylene	6	3/8"	1/4"	10m
040718R	Acetylene	8	3/8"	3/8"	10m
040715R	Acetylene	10	3/8"	3/8"	10m
040705P	Propane	6	3/8"	3/8"	10m
040712P	Propane	6	3/8"	1/4"	10m
040718P	Propane	8	3/8"	3/8"	10m
040715P	Propane	10	3/8"	3/8"	10m

Code	Gas	Hose Diam. (mm)	Fittings	Check Valve	Length
030803B	Oxygen	8	3/8"	3/8"	30m
030905B	Oxygen	10	3/8"	3/8"	30m
030803R	Acetylene	8	3/8"	3/8"	30m
030905R	Acetylene	10	3/8"	3/8"	30m
030803P	Propane	8	3/8"	3/8"	30m
030905P	Propane	10	3/8"	3/8"	30m

### Twin/ Siamese Fitted Hose

Code	Gas	Hose Diam. (mm)	Fittings	Check Valve	Length
040723	Oxygen/ Acetylene	6	3/8"	3/8"	5m
040724	Oxygen/ Acetylene	6	3/8"	1/4"	5m



EN 1256:2006

EN ISO3821:2010

## Argon / Inert Gas Hose

### Clear

PVC braided inert gas hose for use in MIG & TIG. Unfitted 30m length.



FUTURIS™

Code	Description
040707	Clear 6mm
040708	Clear 8mm
040709	Clear 10mm

### Black

Black inert gas hose fully certified to EN ISO3821:2010



FUTURIS™

Code	Description
040725	Black 6mm - 100m - 1/4"
040727	Black 10mm - 100m - 3/8"

EN ISO3821:2010

## Twin/Siamese Hose - Oxygen/Acetylene

Twin/Siamese line EN ISO3821:2010 Oxygen & Acetylene hoses bonded together at manufacture to create a single easy-to-handle hose.

Available in 50m unfitted or 5m fitted sets.



FUTURIS™

Code	Description
040720	Unfitted Twin Hose 6mm - 50m
040722	Unfitted Twin Hose 10mm - 50m
040723	6mm - 5m with 3/8" HSCV fittings
040724	6mm - 5m with 1/4" HSCV fittings

EN ISO3821:2010

## Unfitted Hose

High quality EN ISO3821:2010 certified hose on 100m coils. Highly resistant to kinks and abrasion. Available in 6, 8 and 10mm for oxygen, acetylene and propane gases.



FUTURIS™

Code	Description
040730	Acetylene 6mm
040732	Acetylene 8mm
040734	Acetylene 10mm
040731	Oxygen 6mm
040733	Oxygen 8mm
040735	Oxygen 10mm
040701	Propane 6mm
040702	Propane 8mm
040703	Propane 10mm

EN ISO3821:2010

## Double Safety Check Valves (HSCV)

Used to prevent the reverse flow of gases beyond the torch inlets.

- Manufactured to an approved design with a unique method of assembly to eliminate the use of soldered or bonded joints.
- For use with oxygen (Right-Hand) or fuel gases (Left-Hand).
- Can be used on nozzle mix and injector type torches or machine cutting torches.
- Manufactured to EN730-2.



Code	Description	Code	Description
040821	1/4" Nut 6mm Tail RH	040822	1/4" Nut 6mm Tail LH
040823	3/8" Nut 6mm Tail RH	040824	3/8" Nut 6mm Tail LH
040825	3/8" Nut 8mm Tail RH	040826	3/8" Nut 8mm Tail LH
040827	3/8" Nut 10mm Tail RH	040828	3/8" Nut 10mm Tail LH

EN730-2

## In-Line RF53N Flashback Arrestors

WITT RF series flashback arrestors offer reliable protection against dangerous reverse gas flow and flashbacks.

- If a flashback occurs, gas flow will stop and the arrestor must be replaced.
- Every Arrestor 100% tested.
- Manufactured to EN730 / ISO5175-1.



Code	Description
WIT145.012	3/8" BSP LH Acetylene/Propane
WIT145.022	3/8" BSP RH Oxygen

EN 730 / ISO 5175-1

## Resettable Super 55 Flashback Arrestors

WITT Super series resettable flashback arrestors offer reliable protection against dangerous reverse gas flow and flashbacks.

- If a flashback occurs, the unit can be re-set.
- Every Arrestor 100% tested.
- Manufactured to EN730 / ISO5175-1.



Code	Description
WIT146.001	3/8" BSP LH Acetylene/Propane
WIT146.002	3/8" BSP RH Oxygen

EN 730 / ISO 5175-1

## Couplers

Used to join two pre-fitted hose lengths together.

- Available in different BSP sizes to suit various fitting combinations.
- RH (Right-Hand) to suit oxygen and LH (Left-Hand) to suit fuel gases.



**FUTURIS** ▶

Code	Description
040841	1/4" - 1/4" BSP RH Male
040843	1/4" - 3/8" BSP RH Male
040845	3/8" - 3/8" BSP RH Male
040842	1/4" - 1/4" BSP LH Male
040844	1/4" - 3/8" BSP LH Male
040846	3/8" - 3/8" BSP LH Male

## Splicers

Joins same sized hose lengths when used with O clips.

- Normally used when a damaged piece of hose is cut out.



**FUTURIS** ▶

Code	Description
040831	6mm
040832	8mm
040833	10mm

## Tailnuts & Tails

Combine the correct size nut and a tail to fit a hose ready for connection.



Tail



Tailnut

**FUTURIS** ▶

Code	Description	Code	Description
040851	Tailnuts 1/4" BSP RH	040861	Tails 1/4" Nut 6mm 1/4" Tail
040853	Tailnuts 3/8" BSP RH	040864	Tails 3/8" Nut 6mm 1/4" Tail
040852	Tailnuts 1/4" BSP LH	040863	Tails 3/8" Nut 5mm 3/16" Tail
040854	Tailnuts 3/8" BSP LH	040866	Tails 3/8" Nut 8mm 5/16" Tail
		040867	Tails 3/8" Nut 10mm 3/8" Tail

## Adaptors

Used to convert a gas torch fitting to match the gas supply hose.

- Available in various combinations for oxygen and fuel gases.



Straight

**FUTURIS** ▶



Bent

Code	Description
040881	1/4" Nut - 3/8" - RH Bent
040882	1/4" Nut - 3/8" - LH Bent
040883	1/4" Nut - 3/8" - RH Straight
040884	3/8" Nut - 1/4" - RH Straight
040885	1/4" Nut - 3/8" - LH Straight
040886	3/8" Nut - 1/4" - LH Straight

## Double Outlets

Allows two sets of gas hoses to be connected to one outlet. The gas flow can be adjusted or cut off from each outlet independently. Each down line piece of equipment must have its own safety devices (flashback arrestors, etc...)



Oxygen



Acetylene

Code	Description
040869	Oxygen Valved 3/8" BSP RH
040870	Acetylene Valved 3/8" BSP LH

## O Clips

Used for hose fastening to create a gas-tight seal at the end of hoses.

- Available in a wide range of sizes.
- To be used with O clip pincers (040755).
- Packed in 100s



Code	Description
040744	8mm 5/16" - 7-9mm hose outer diameter
040745	10mm 3/8" - 9-11mm hose outer diameter
040746	11mm 7/16" - 10-12mm hose outer diameter
040747	13mm 1/2" - 11-13mm hose outer diameter
040750	22mm 7/8" - 20-23mm hose outer diameter
040751	15mm 9/16" - 13-15mm hose outer diameter
040752	15.2mm 19/32" - 15-17mm hose outer diameter
040753	16mm 5/8" - 15-18mm hose outer diameter
040754	19mm 3/4" - 17-20mm hose outer diameter

## O Clip Pincers

Specific tool to correctly close gas hose O clips ears.



Code	Description
040755	O Clip Pincers



## Red Pistol

Pistol style spark lighter to ignite gas welding torch.



Flints for Red Pistol Spark Lighter



Code	Description
040630	Red Pistol
040634	Replacement Pistol Flints - Pack of 10

## Cup Type

Cup style spark lighter to ignite gas welding torch. Also available in the American manufactured Shurlite version.



Flints for Cup Type Spark Lighter



Code	Description
040631	Futuris Cup Type
040631/A	Shurlite Cup Type
040632	Replacement Cup Flints - Pack of 10

## Triple Flint

Triple flint style spark lighter to ignite gas welding torch. As the flint wears simply and quickly turn the triangle of flints to the next position. Also available in the American manufactured Shurlite version.



Flints for Triple Flint Spark Lighter



Code	Description
040635	Futuris Triple Flint
040635/A	Shurlite Triple Flint
040636	Replacement Triple Flints - Triangle of 3

## Quartz Electronic

Quartz electronic style spark lighter to ignite gas welding torch. No flint required. The handle design ensures your hand is kept well away from sparks.



Code	Description
FUT040637	Quartz Electronic

### Nozzle Cleaners

Various files and reamers for cleaning and maintaining all gas cutting, heating & welding nozzles.



FUTURIS™

Code	Description
040382	Nozzle Cleaners

### Combination Spanner & Spindle Key

Drop forged combination spanner: 3/8" BSP on one end for hose fittings and 5/8" BSP for regulators to cylinder nuts.



FUTURIS™

Code	Description
040762	Drop Forged Combination Spanner

Drop forged cylinder spindle key. Turns valves on most British style cylinders.



FUTURIS™

Code	Description
040764	Drop Forged Spindle Key

### Blowpipe Spanner

Flat spanner for use on Nozzle Mix, Type III/HD & Lightweight cutting torches. Eight different nut sizes on one simple spanner.



FUTURIS™

Code	Description
040763	Blowpipe Spanner



Weldspares has the widest range of 3M™ and Speedglas™ products outside of the 3M™ network.

Call us now on 01925 666198 with your requirements.

**3M**

### Twin Oxygen/Acetylene

Capacity	2 x Cylinders
Height	90cm
Base size	Width 57cm (split 30-24cm) Depth 26cm
Wheel type & size	20cm Solid Rubber
Cylinder Restraint	Adjustable Chain
Construction	Round Powder Coated Tube
Net Weight	10Kg

FUTURIS™



For pneumatic wheeled version, see page 49

Code	Description
040741	Twin Oxygen/Acetylene Trolley

### Twin Three-Wheel Oxygen/Acetylene

Capacity	2 x Cylinders
Height	145cm
Base size	Width 57cm (split 30-24cm) Depth 26cm
Wheel type & size	20cm Solid Rubber
Cylinder Restraint	Adjustable Chain
Construction	Square Powder Coated Tube
Net Weight	18Kg

FUTURIS™



Code	Description
040749	Twin Three-Wheel Oxygen/Acetylene Trolley

### Twin Oxygen/Propane

Capacity	2 x Cylinders
Height	90cm
Base size	Width 65cm (split 37-26cm) Depth 30cm
Wheel type & size	20cm Solid Rubber
Cylinder Restraint	Adjustable Chain
Construction	Round Powder Coated Tube
Net Weight	12Kg

FUTURIS™

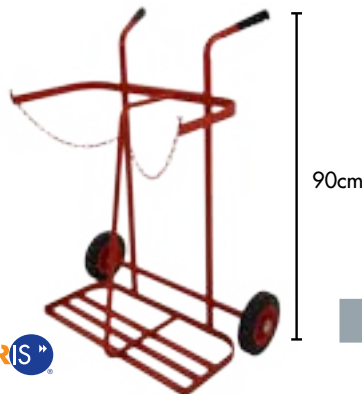

For pneumatic wheeled version, see page 49

Code	Description
040742	Twin Oxygen/Propane Trolley

### Midi Closed Handle

Capacity	2 x Cylinders
Height	106cm
Base size	Width 65cm (split 37-26cm) Depth 20cm
Wheel type & size	20cm Solid Rubber
Cylinder Restraint	Adjustable Chain
Construction	Round Powder Coated Tube
Net Weight	10Kg

FUTURIS™



Code	Description
040761	Midi Closed Handle Trolley



# ▶ Gas Equipment

## Standard Cylinder Trolleys

### Small Single

Capacity	1 x Cylinder
Height	98cm
Base size	Width 23.5cm Depth 30cm
Wheel type & size	20cm Solid Rubber
Cylinder Restraint	2 x Adjustable Chains
Construction	Square Powder Coated Tube
Net Weight	7.5Kg



Code	Description
040736	Small Single Trolley

### Single Oxygen/Acetylene

Capacity	1 x Cylinder
Height	80cm
Base size	Width 27.5cm Depth 20cm
Wheel type & size	20cm Solid Rubber
Cylinder Restraint	Adjustable Chain
Construction	Round Powder Coated Tube
Net Weight	7.5Kg

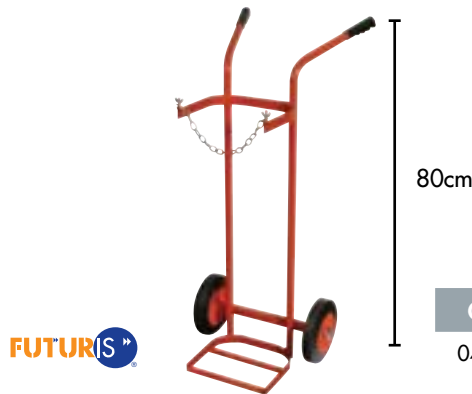

Code	Description
040743	Single Oxygen/Acetylene Trolley

### Single Propane

Capacity	1 x Cylinder
Height	102cm
Base size	Width 38cm Depth 30cm
Wheel type & size	20cm Solid Rubber
Cylinder Restraint	Adjustable Chain
Construction	Round Powder Coated Tube
Net Weight	11Kg



Code	Description
040738	Single Propane Trolley

### Portakit with Extending Handle

Capacity	2 x Cylinders
Height	From 58cm to 100cm
Base size	Width 43cm (split 17-19cm) Depth 18cm
Wheel type & size	20cm Solid Rubber
Cylinder Restraint	Shaped Bar - Thumbscrew
Construction	Square Powder Coated Tube
Net Weight	6.5Kg



Code	Description
040759	Portakit Trolley

## Three Wheel Single

Capacity	1 x Cylinders
Height	130cm
Base size	Width 17cm Depth 21cm
Wheel type & size	20cm Solid Rubber
Cylinder Restraint	Adjustable Chain
Construction	Round Powder Coated Tube
Net Weight	11.5Kg

**FUTURIS**™



130cm

Code	Description
040758	Three Wheel Single Trolley

## Portakit Stand

Capacity	2 x Cylinders
Height	63cm
Base size	Width 35cm (split 13-15cm) Depth 19cm
Wheel type & size	20cm Solid Rubber
Cylinder Restraint	Shaped Bar - Thumbscrew
Construction	Square Powder Coated Tube
Net Weight	3.5Kg

**FUTURIS**™



63cm

Code	Description
040770	Portakit Stand

## Portakit

Capacity	2 x Cylinders
Height	89.5cm
Base size	Width 35.8cm (split 18-18cm) Depth 15.5cm
Wheel type & size	20cm Solid Rubber
Cylinder Restraint	Solid Bar - Wing Nut Adjustable
Construction	Round Powder Coated Tube
Net Weight	8Kg

**FUTURIS**™



89.5cm

Code	Description
040740	Portakit Stand



Need more information? Log on to [www.weldspares.co.uk](http://www.weldspares.co.uk) for:

- latest RRP for all products
- pictures & specifications
- downloadable catalogues
- technical datasheets

# ▶ Gas Equipment

## Heavy Duty Cylinder Trolleys

### Oxygen- Acetylene Heavy Duty

Capacity	2 x Cylinders
Height	130cm
Base size	Width 56cm (split 28-25cm) Depth 30cm
Wheel type & size	30cm Solid Rubber
Cylinder Restraint	Adjustable Chain
Construction	Square Powder Coated Tube
Net Weight	21.5Kg



130cm

Code	Description
040760	Oxy/Ace Heavy Duty Trolley

### Oxygen- Propane Heavy Duty

Capacity	2 x Cylinders
Height	116cm
Base size	Width 65cm (split 39-24cm) Depth 26cm
Wheel type & size	30cm Solid Rubber
Cylinder Restraint	Adjustable Chain
Construction	Square Powder Coated Tube
Net Weight	13Kg



116cm

Code	Description
040765	Oxy/Prop Heavy Duty Trolley

### Single Heavy Duty

Capacity	1 x Cylinders
Height	120cm
Base size	Width 30.5m Depth 23cm
Wheel type & size	30cm Solid Rubber
Cylinder Restraint	2x Adjustable Chains
Construction	Square Powder Coated Tube
Net Weight	13Kg



120cm

Code	Description
040766	Single Heavy Duty Trolley

### Oxygen/Acetylene Pneumatic Wheels

Capacity	2 x Cylinders
Height	102cm
Base size	Width 57cm (split 30.6-24.5cm) Depth 25cm
Wheel type & size	30cm Pneumatic Rubber
Cylinder Restraint	Adjustable Chain
Construction	Round Powder Coated Tube
Net Weight	12.5Kg

FUTURIS™



102cm

Pneumatic wheels for uneven terrains

Code	Description
040741/B	Oxygen/Acetylene Site Trolley

### Oxygen/Propane Pneumatic Wheels

Capacity	2 x Cylinders
Height	102cm
Base size	Width 65cm (split 38-25.5cm) Depth 30cm
Wheel type & size	30cm Pneumatic Rubber
Cylinder Restraint	Adjustable Chain
Construction	Round Powder Coated Tube
Net Weight	14Kg

FUTURIS™



102cm

Pneumatic wheels for uneven terrains

Code	Description
040742/B	Oxygen/Propane Site Trolley

## Full Speedglas range available!

**Speedglas™**

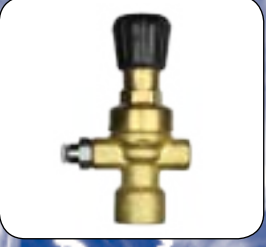

# MIG Welding ▶▶

Binzel Style FF-M15 Torches	52
Binzel Style FF-M15 Consumables	53
Binzel Style FF-M25 Torches	54
Binzel Style FF-M25 Consumables	55
Binzel Style FF-M36 Torches	56
Binzel Style FF-M36 Consumables	57
Binzel Style FF-M501 Torches	58
Binzel Style FF-M501 Consumables	59
Tweco Style MIG Torches	60
Tweco Style MIG Accessories	61
Bernard Style MIG Torches & Consumables	62
Tops MIG Torches & Accessories	63
MIG Welding Accessories	64
MIG Wire Treatment	65

# ►► MIG Welding

## Binzel Style FF-M15 Torches

### FF-M15 Binzel Style MIG Torch

The FF-M MIG/MAG Torch Series is designed to provide quality and comfort during welding. Used throughout the welding industry including automotive, aircraft and steel construction environments.

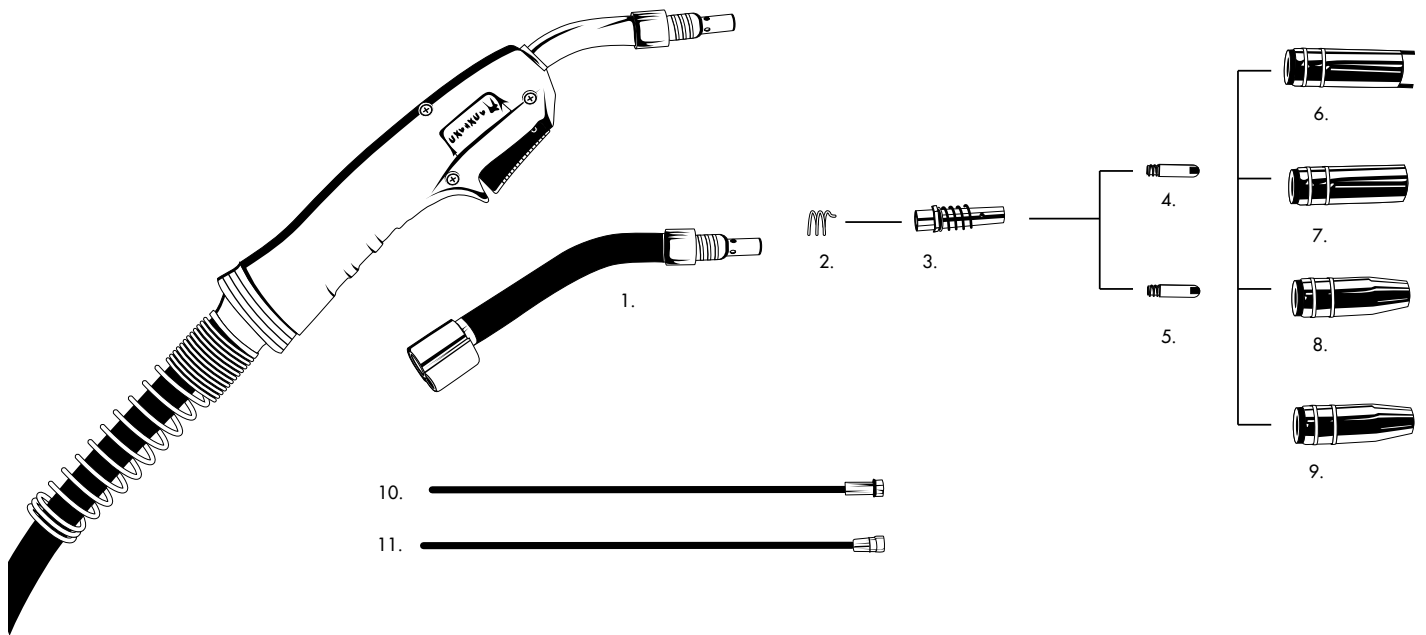

**FUTURIS**™



EN 60974-7



- Interchangeable with the best known European brands
- Compact & lightweight with great reliability
- Ergonomic handle
- Articulated cable joint for manoeuvrability
- Standard Euro spring-pin attachment
- High quality super flexible mono cable

Technical Data	
Cooling	Air cooled
Wire Ø mm	0.6 - 1.0mm
Duty Cycle 60%	180A CO <sub>2</sub> 150A Mixed Gases

#### Description

#### Code

#### Pack

#### FF-M15 Torches

FF-M15 MIG Welding Torch - 3m

FUTM15-3

1

FF-M15 MIG Welding Torch - 4m

FUTM15-4

1

### FF-M15 Consumables

Description	Key	Code	Pack
<b>Main</b>			
Swan Neck	1.	FUTM1550	1
Nozzle Spring	2.	FUTM15SPR	5
Contact Tip Holder	3.	FUTM15356	5
<b>Nozzles</b>			
Conical Ø 12mm	6.	FUTM1512CON	5
Cylindrical Ø 16mm	7.	FUTM1516CYL	5
Tapered Ø 9.5mm	8.	FUTM1595TAP	5
Spot Welding Ø 16mm	9.	FUTM1516SPOT	5
<b>Contact tips</b>			
E-Cu M6 x 25mm Ø 0.6mm	4.	FUTM15066	20
E-Cu M6 x 25mm Ø 0.8mm	4.	FUTM15086	20
E-Cu M6 x 25mm Ø 1.0mm	4.	FUTM15106	20
E-Cu M6 x 25mm Ø 1.2mm	4.	FUTM15126	20
E-Cu M6 x 25mm Ø 0.8mm for Alu wire	5.	FUTM15086A	20
E-Cu M6 x 25mm Ø 0.9mm for Alu wire	5.	FUTM15096A	20
E-Cu M6 x 25mm Ø 1.0mm for Alu wire	5.	FUTM15106A	20
<b>Liners</b>			
Steel Blue 0.6 - 0.9mm 3m	10.	FUTM06093INS	1
Steel Blue 0.6 - 0.9mm 4m	10.	FUTM06094INS	1
Steel Red 1.0 - 1.2mm 3m	10.	FUTM10123INS	1
Steel Red 1.0 - 1.2mm 4m	10.	FUTM10124INS	1
Steel Red 1.0 - 1.2mm 5m	10.	FUTM10125INS	1
Teflon Blue 0.6 - 0.9mm 3m	11.	FUTM06103TEF	1
Teflon Blue 0.6 - 0.9mm 4m	11.	FUTM06104TEF	1
Teflon Red 1.0 - 1.2mm 3m	11.	FUTM10143TEF	1
Teflon Red 1.0 - 1.2mm 4m	11.	FUTM10144TEF	1

# ►► MIG Welding

## Binzel Style FF-M25 Torches

### FF-M25 Torch

The FF-M MIG/MAG Torch Series is designed to provide quality and comfort during welding. Used throughout the welding industry including automotive, aircraft and steel construction environments.

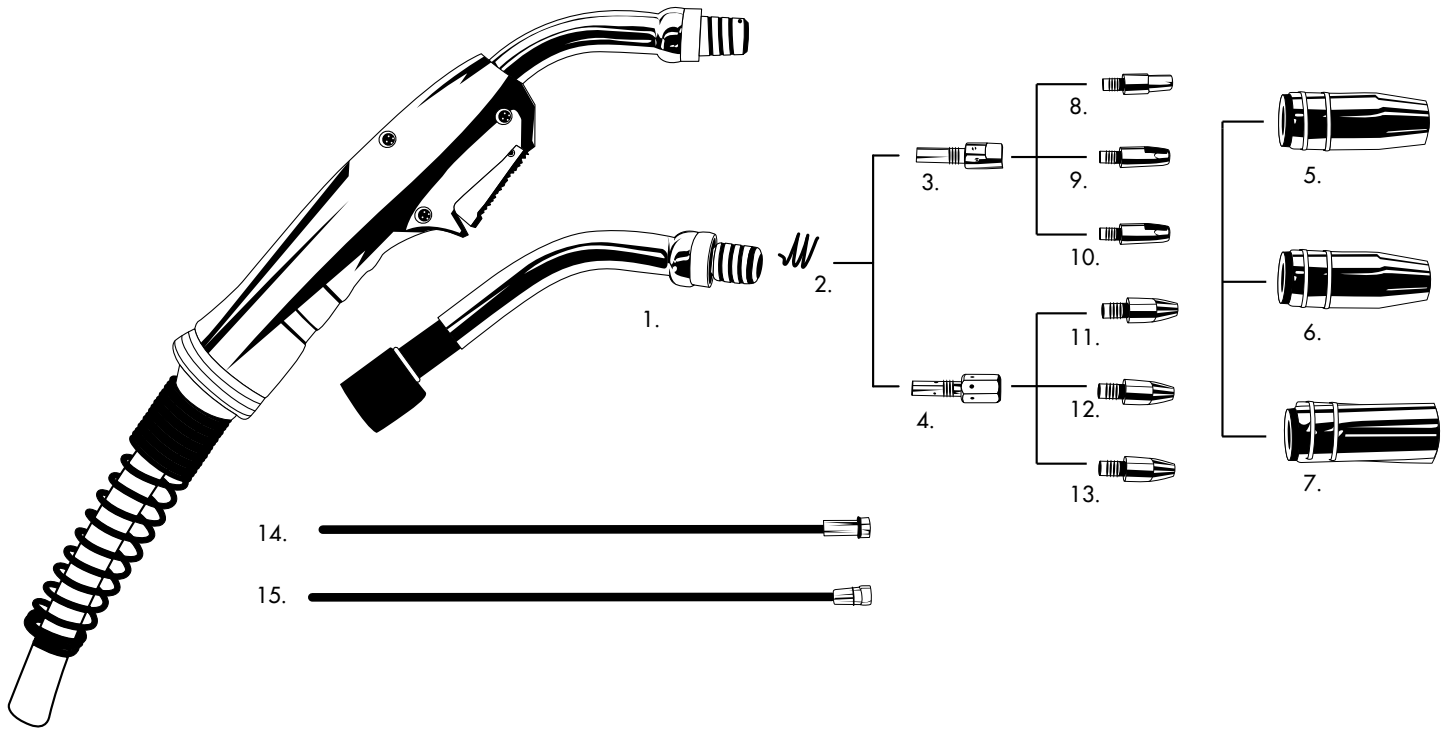

**FUTURIS**™



EN 60974-7



- Interchangeable with the best known European brands
- Compact & lightweight with great reliability
- Ergonomic handle
- Articulated cable joint for manoeuvrability
- Standard Euro spring-pin attachment
- High quality super flexible mono cable

Technical Data	
Cooling	Air cooled
Wire Ø mm	0.6 - 1.2mm
Duty Cycle 60%	200A Mixed Gases

Description	Code	Pack
<b>FF-M25 Torches</b>		
FF-M25 MIG Welding Torch - 3m	FUTM25-3	1
FF-M25 MIG Welding Torch - 4m	FUTM25-4	1
FF-M25 MIG Welding Torch - 5m	FUTM25-5	1



### FF-M25 Consumables

Description	Key	Code	Description	Key	Code
<b>Main</b>					
Swan Neck	1.	FUTM2550			
Nozzle Spring	2.	FUTM25SPR			
Contact Tip Holder M6	3.	FUTM25356			
Contact Tip Holder M8	4.	FUTM25358			
<b>Nozzles</b>					
Conical Ø 15mm	5.	FUTM2515CON			
Cylindrical Ø 18mm	7.	FUTM2518CYL			
Tapered Ø 11.5mm	6.	FUTM25115TAP			
<b>Contact tips</b>					
E-Cu M6 x 28mm Ø 0.6mm	8.	FUTM2536066	E-Cu M8 x 30mm Ø 0.8mm	11.	FUTM40501088
E-Cu M6 x 28mm Ø 0.8mm	8.	FUTM2536086	E-Cu M8 x 30mm Ø 1.0mm	11.	FUTM40501108
E-Cu M6 x 28mm Ø 1.0mm	8.	FUTM2536106	E-Cu M8 x 30mm Ø 1.2mm	11.	FUTM40501128
E-Cu M6 x 28mm Ø 1.2mm	8.	FUTM2536126	E-Cu M8 x 30mm Ø 1.4mm	11.	FUTM40501148
E-Cu M6 x 28mm Ø 1.6mm	8.	FUTM2536166	E-Cu M8 x 30mm Ø 1.6mm	11.	FUTM40501168
E-Cu M6 x 28mm Ø 0.8mm (Alu wire)	9.	FUTM2536086A	E-Cu M8 x 30mm Ø 2.0mm	11.	FUTM40501208
E-Cu M6 x 28mm Ø 1.0mm (Alu wire)	9.	FUTM2536106A	E-Cu M8 x 30mm Ø 2.4mm	11.	FUTM40501248
E-Cu M6 x 28mm Ø 1.2mm (Alu wire)	9.	FUTM2536126A	E-Cu M8 x 30mm Ø 0.8mm (Alu wire)	12.	FUTM40501088A
CuCrZr M6 x 28mm Ø 0.8mm	10.	FUTM2536086HD	E-Cu M8 x 30mm Ø 1.0mm (Alu wire)	12.	FUTM40501108A
CuCrZr M6 x 28mm Ø 1.0mm	10.	FUTM2536106HD	E-Cu M8 x 30mm Ø 1.2mm (Alu wire)	12.	FUTM40501128A
CuCrZr M6 x 28mm Ø 1.2mm	10.	FUTM2536126HD	CuCrZr M8 x 30mm Ø 1.0mm	13.	FUTM40501108HD
			CuCrZr M8 x 30mm Ø 1.2mm	13.	FUTM40501128HD
			CuCrZr M8 x 30mm Ø 1.4mm	13.	FUTM40501148HD
			CuCrZr M8 x 30mm Ø 1.6mm	13.	FUTM40501168HD
<b>Liners</b>					
Steel Blue 0.6 - 0.9mm 3m	14.	FUTM06093INS			
Steel Blue 0.6 - 0.9mm 4m	14.	FUTM06094INS			
Steel Red 1.0 - 1.2mm 3m	14.	FUTM10123INS			
Steel Red 1.0 - 1.2mm 4m	14.	FUTM10124INS			
Steel Red 1.0 - 1.2mm 5m	14.	FUTM10125INS			
Teflon Blue 0.6 - 0.9mm 3m	15.	FUTM06103TEF			
Teflon Blue 0.6 - 0.9mm 4m	15.	FUTM06104TEF			
Teflon Red 1.0 - 1.2mm 3m	15.	FUTM10143TEF			
Teflon Red 1.0 - 1.2mm 4m	15.	FUTM10144TEF			

# ►► MIG Welding

## Binzel Style FF-M36 Torches

### FF-M36 Torch

The FF-M MIG/MAG Torch Series is designed to provide quality and comfort during welding. Used throughout the welding industry including automotive, aircraft and steel construction environments.

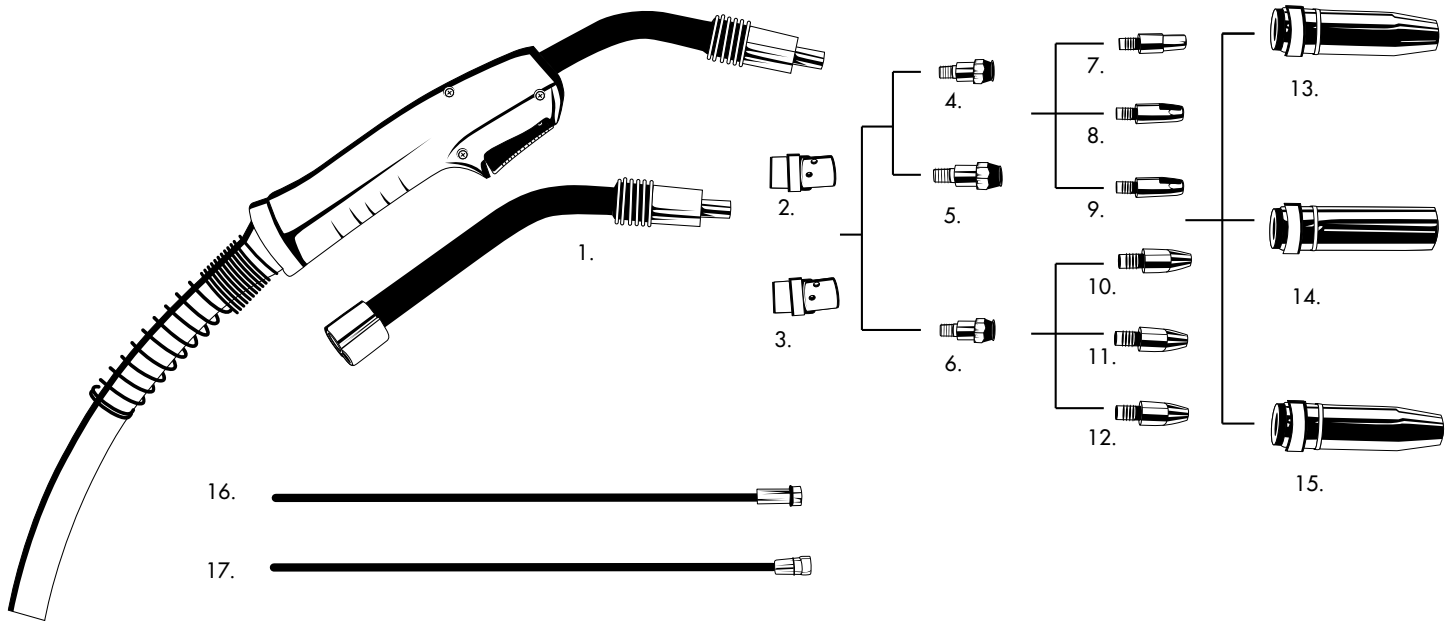

**FUTURIS** ►



EN 60974-7



- Interchangeable with the best known European brands
- Compact & lightweight with great reliability
- Ergonomic handle
- Articulated cable joint for manoeuvrability
- Standard Euro spring-pin attachment
- High quality super flexible mono cable

Technical Data	
Cooling	Air cooled
Wire Ø mm	0.6 - 1.2mm
Duty Cycle 60%	340A CO <sub>2</sub> 320A Mixed Gases

#### Description

#### FF-M36 Torches

- FF-M36 MIG Welding Torch - 3m
- FF-M36 MIG Welding Torch - 4m
- FF-M36 MIG Welding Torch - 5m

#### Code

- FUTM36-3
- FUTM36-4
- FUTM36-5

#### Pack

- 1
- 1
- 1

### FF-M36 Consumables

Description	Key	Code	Description	Key	Code
<b>Main</b>					
Swan Neck	1.	FUTM3650			
Gas Diffuser White	2.	FUTM36DIF			
Gas Diffuser Black	3.	FUTM36DIFBLACK			
Contact Tip Holder M6 Short	4.	FUTM36286			
Contact Tip Holder M6 Long	5.	FUTM36316			
Contact Tip Holder M8 Short	6.	FUTM36288			
<b>Nozzles</b>					
Conical Ø 16mm	13.	FUTM3616CON			
Cylindrical Ø 19mm	14.	FUTM3619CYL			
Tapered Ø 12mm	15.	FUTM3612TAP			
<b>Contact tips</b>					
E-Cu M6 x 28mm Ø 0.6mm	7.	FUTM2536066	E-Cu M8 x 30mm Ø 0.8mm	10.	FUTM40501088
E-Cu M6 x 28mm Ø 0.8mm	7.	FUTM2536086	E-Cu M8 x 30mm Ø 1.0mm	10.	FUTM40501108
E-Cu M6 x 28mm Ø 1.0mm	7.	FUTM2536106	E-Cu M8 x 30mm Ø 1.2mm	10.	FUTM40501128
E-Cu M6 x 28mm Ø 1.2mm	7.	FUTM2536126	E-Cu M8 x 30mm Ø 1.4mm	10.	FUTM40501148
E-Cu M6 x 28mm Ø 1.6mm	7.	FUTM2536166	E-Cu M8 x 30mm Ø 1.6mm	10.	FUTM40501168
E-Cu M6 x 28mm Ø 0.8mm (Alu wire)	8.	FUTM2536086A	E-Cu M8 x 30mm Ø 2.0mm	10.	FUTM40501208
E-Cu M6 x 28mm Ø 1.0mm (Alu wire)	8.	FUTM2536106A	E-Cu M8 x 30mm Ø 2.4mm	10.	FUTM40501248
E-Cu M6 x 28mm Ø 1.2mm (Alu wire)	8.	FUTM2536126A	E-Cu M8 x 30mm Ø 0.8mm (Alu wire)	11.	FUTM40501088A
CuCrZr M6 x 28mm Ø 0.8mm	9.	FUTM2536086HD	E-Cu M8 x 30mm Ø 1.0mm (Alu wire)	11.	FUTM40501108A
CuCrZr M6 x 28mm Ø 1.0mm	9.	FUTM2536106HD	E-Cu M8 x 30mm Ø 1.2mm (Alu wire)	11.	FUTM40501128A
CuCrZr M6 x 28mm Ø 1.2mm	9.	FUTM2536126HD	CuCrZr M8 x 30mm Ø 1.0mm	12.	FUTM40501108HD
			CuCrZr M8 x 30mm Ø 1.2mm	12.	FUTM40501128HD
			CuCrZr M8 x 30mm Ø 1.4mm	12.	FUTM40501148HD
			CuCrZr M8 x 30mm Ø 1.6mm	12.	FUTM40501168HD
<b>Liners</b>					
Steel Blue 0.6 - 0.9mm 3m	16.	FUTM06093INS			
Steel Blue 0.6 - 0.9mm 4m	16.	FUTM06094INS			
Steel Red 1.0 - 1.2mm 3m	16.	FUTM10123INS			
Steel Red 1.0 - 1.2mm 4m	16.	FUTM10124INS			
Steel Red 1.0 - 1.2mm 5m	16.	FUTM10125INS			
Teflon Blue 0.6 - 0.9mm 3m	17.	FUTM06103TEF			
Teflon Blue 0.6 - 0.9mm 4m	17.	FUTM06104TEF			
Teflon Red 1.0 - 1.2mm 3m	17.	FUTM10143TEF			
Teflon Red 1.0 - 1.2mm 4m	17.	FUTM10144TEF			

# ►► MIG Welding

## Binzel Style FF-M501 Torches

### FF-M501 Torch - Water Cooled

The FF-M MIG/MAG Torch Series is designed to provide quality and comfort during welding. Used throughout the welding industry including automotive, aircraft and steel construction environments.

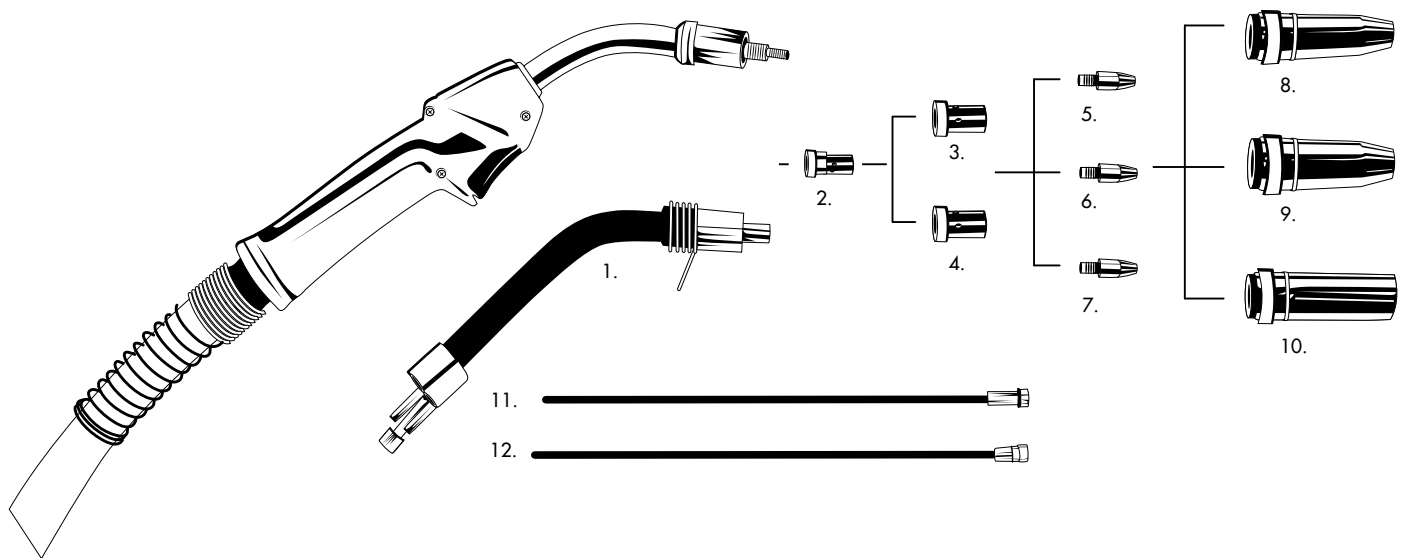

**FUTURIS**™



EN 60974-7

- Interchangeable with the best known European brands
- Compact & lightweight with great reliability
- Ergonomic handle
- Articulated cable joint for manoeuvrability
- Standard Euro spring-pin attachment
- High quality super flexible mono cable

Technical Data	
Cooling	Water cooled
Wire Ø mm	0.8mm to 2.4mm
Duty Cycle 100%	500Amps

#### Description

#### Code

#### Pack

#### FF-M501 Torches

FF-M501 MIG Welding Torch - 3m  
 FF-M501 MIG Welding Torch - 4m  
 FF-M501 MIG Welding Torch - 5m

FUTM501-3  
 FUTM501-4  
 FUTM501-5

1  
 1  
 1

### FF-M501 Consumables

Description	Key	Code	Pack
<b>Main</b>			
Swan Neck	1.	FUTM50150	1
Gas Diffuser White	2.	FUTM501DIF	5
Gas Diffuser Black	2.	FUTM501DIFBLACK	5
Contact Tip Holder M8 Short	3.	FUTM501258	5
Contact Tip Holder M8 Long	4.		5
<b>Nozzles</b>			
Conical Ø 16mm	8.	FUTM50116CON	5
Cylindrical Ø 20mm	9.	FUTM50120CYL	5
Tapered Ø 14mm	10.	FUTM50114TAP	5
<b>Contact tips</b>			
E-Cu M8 x 30mm Ø 0.8mm	5.	FUTM40501088	20
E-Cu M8 x 30mm Ø 1.0mm	5.	FUTM40501108	20
E-Cu M8 x 30mm Ø 1.2mm	5.	FUTM40501128	20
E-Cu M8 x 30mm Ø 1.4mm	5.	FUTM40501148	20
E-Cu M8 x 30mm Ø 1.6mm	5.	FUTM40501168	20
E-Cu M8 x 30mm Ø 2.0mm	5.	FUTM40501208	20
E-Cu M8 x 30mm Ø 2.4mm	5.	FUTM40501248	20
E-Cu M8 x 30mm Ø 0.8mm for Alu wire	6.	FUTM40501088A	20
E-Cu M8 x 30mm Ø 1.0mm for Alu wire	6.	FUTM40501108A	20
E-Cu M8 x 30mm Ø 1.2mm for Alu wire	6.	FUTM40501128A	20
CuCrZr M8 x 30mm Ø 1.0mm	7.	FUTM40501108HD	20
CuCrZr M8 x 30mm Ø 1.2mm	7.	FUTM40501128HD	20
CuCrZr M8 x 30mm Ø 1.4mm	7.	FUTM40501148HD	20
CuCrZr M8 x 30mm Ø 1.6mm	7.	FUTM40501168HD	20
<b>Liners</b>			
Steel Blue 0.6 - 0.9mm 3m	11.	FUTM06093INS	1
Steel Blue 0.6 - 0.9mm 4m	11.	FUTM06094INS	1
Steel Red 1.0 - 1.2mm 3m	11.	FUTM10123INS	1
Steel Red 1.0 - 1.2mm 4m	11.	FUTM10124INS	1
Steel Red 1.0 - 1.2mm 5m	11.	FUTM10125INS	1
Teflon Blue 0.6 - 0.9mm 3m	12.	FUTM06103TEF	1
Teflon Blue 0.6 - 0.9mm 4m	12.	FUTM06104TEF	1
Teflon Red 1.0 - 1.2mm 3m	12.	FUTM10143TEF	1
Teflon Red 1.0 - 1.2mm 4m	12.	FUTM10144TEF	1

# ►► MIG Welding

## Tweco Style MIG Torches

### Futuris Tweco Style MIG Torch No.4

The Futuris Tweco Style MIG Torch No.4 a traditional style MIG gun

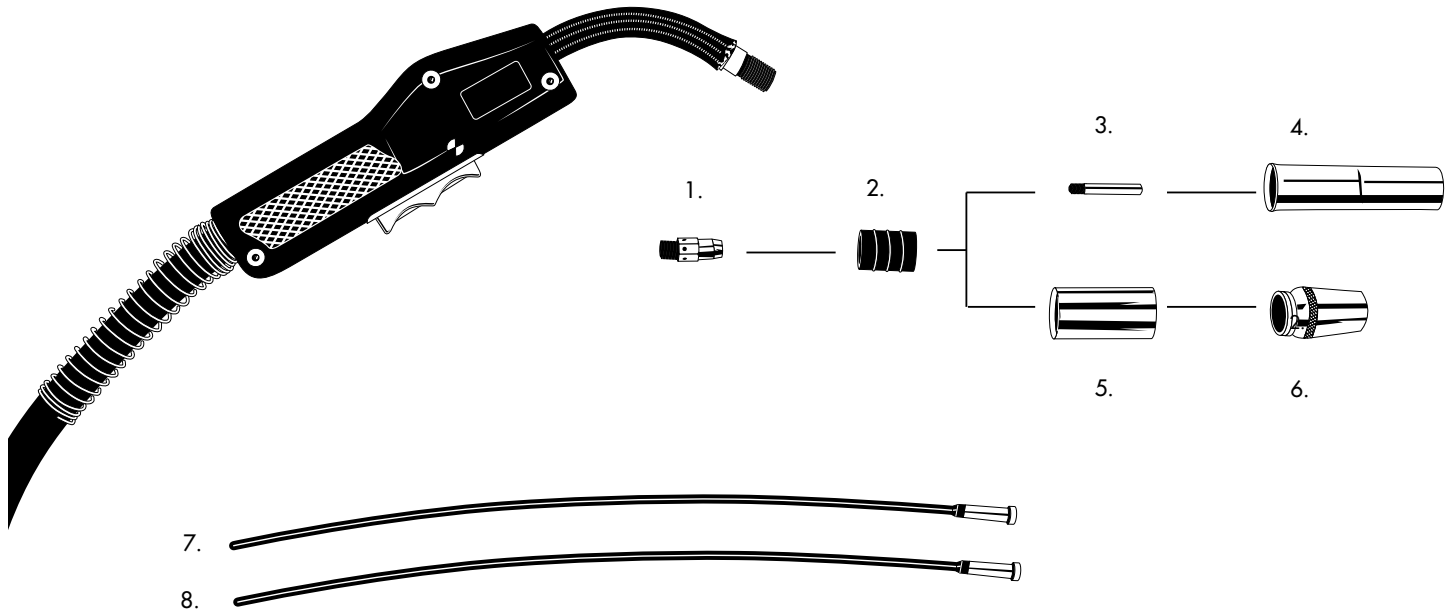

- For use in all semi-automatic air cooled MIG Welding applications
- Metal jacket conductor tube
- Enhanced direct plug capabilities

Technical Data	
Cooling	Air Cooled
Wire Ø mm	0.6mm to 2.0mm
Duty Cycle 80%	CO <sub>2</sub> Gases

Description	Code	Pack
<b>Futuris Tweco Style No.4 Torches</b>		
Futuris Tweco Style No.4 Torch 12ft	FUTMT4-12	1
Futuris Tweco Style No.4 Torch 15ft	FUTM14-15	1

### Futuris Tweco Style MIG Accessories

Description	Key	Code	Pack
<b>Main</b>			
Swan Neck Body Tube		FUTMT64A	1
Gas Diffuser / Tip Adaptor	1.	FUTMT54A	10
Adjustable Nozzle Insulator	2.	FUTMT34A	10
Insulator for Course Thread Nozzles	5.	FUTMT34CT	10
<b>Nozzles</b>			
Nozzle Adjustable 12mm Bore	4.	FUTMT24A-50	5
Nozzle Adjustable 12mm Bore		FUTMT24A-62	5
Nozzle Adjustable 12mm Bore		FUTMT24A-75	
Course Thread Nozzle 12mm Bore	6.	FUTMT24CT-50S	5
Course Thread Nozzle 16mm Bore		FUTMT24CT-62S	5
Course Thread Nozzle 19mm Bore		FUTMT24CT-75S	5
<b>Contact tips</b>			
Standard Ecu 0.8mm	3.	FUTMT14-30	20
Standard Ecu 1.0mm		FUTMT14-40	20
Standard Ecu 1.2mm		FUTMT14-45	20
Standard Ecu 1.6mm		FUTMT14-116	20
HD Ecu 0.8mm		FUTMT14H30	20
HD Ecu 1.0mm		FUTMT14H40	20
HD Ecu 1.2mm		FUTMT14H45	20
HD Ecu 1.6mm		FUTMT14H116	20
Standard Ecu 0.8mm		FUTMT15H35	20
Standard Ecu 1.0mm		FUTMT15H40	20
Standard Ecu 1.2mm		FUTMT1545	20
Standard Ecu 2.0mm		FUTMT1564	20
<b>Liners</b>			
Nylon Liner 0.8 - 1.2mm (15ft)	7	FUTMT44N3545-15	1
Nylon Liner 1.6mm (15ft)		FUTMT44N-116-15	1
Steel Liner 0.9-1.2mm (15ft)	8	FUTMT45-3545-15	1
Steel Liner 1.6mm (15ft)		FUTMT44-116-15	1
Steel Liner 2.0mm (15ft)		FUTMT44-564-15	1
Euro Fit Steel Liner 0.9mm-1.2mm (15ft)		FUTMT44-3545-15	1

# ▶▶ MIG Welding

## Bernard Style MIG Torches & Consumables

### Bernard Style MIG Torch & Accessories

Item	Description	Compatible with	Code	Pack
<b>Torches</b>	Bernard Type MIG Torch 4.57m (15ft) X 300 Amp		FUTMBD-4E315AE	1
	Bernard Type MIG Torch 4.57m (15ft) 400 Amp		FUTMBD-4E415AE	1
<b>Main</b>	Swan Neck Body Tube		FUTMBD4790	1
	Tip Adaptor/Diffuser Head Assembly	4335	FUTMBD4335	1
	Tip Adaptor/Diffuser Head Assembly	4435	FUTMBD4435	1
	Tip Adaptor Head Assembly	for 15 Tips	FUTMBD4635	10
	Cap	4323R	FUTMBD4323R	1
	Cap	4423R	FUTMBD4423R	1
	Insulator	4780	FUTMBD4780	10
	Insulator 19.1mm - 3/4"		FUTMBD4061	1
<b>Nozzles</b>	Brass 5/8"	4235/4335	FUTMBD4391	5
	Brass 1/2"	4235/4335	FUTMBD4392	5
	Brass 3/4"	4435	FUTMBD4491	5
	Brass 9/16"	4435/4635	FUTMBD4492	5
	Copper 1/2"	4435/4635	FUTMBD4592	10
	Tapered 3/8"		FUTMBD4295	5
<b>Contact Tips</b>	E-Cu Long 1.0mm	4235/4635	FUTMBD1596	10
	E-Cu Long 1.2mm	4235/4635	FUTMBD1590	10
	E-Cu Long 1.3mm	4235/4635	FUTMBD1598	10
	E-Cu Long 1.6mm	4235/4635	FUTMBD1591	10
	E-Cu Long 2.0mm	4235/4635	FUTMBD1592	10
	E-Cu Short 0.8mm	4335/4435/7392	FUTMBD7488	10
	E-Cu Short 1.0mm	4335/4435/7392	FUTMBD7496	10
	E-Cu Short 1.2mm	4335/4435/7392	FUTMBD7490	10
	E-Cu Short 1.6mm	4335/4435/7392	FUTMBD7491	10
<b>Liners</b>	<b>Liners</b>			
	EZ Liner 0.6 - 0.8mm - 4.57m (15ft)		FUTMBD43015	1
	EZ Liner 0.9 - 1.2mm - 3.05m (10ft)		FUTMBD43110	1
	EZ Liner 1.6mm - 3.05m (10ft)		FUTMBD43210	1
	EZ liner 2.0mm - 4.57m (15ft)		FUTMBD44315	1
	EZ Liner 2.4mm - 4.57m (15ft)		FUTMBD45415	1
	BD Liner 0.9 - 1.2mm 4.5m (15ft)	44115	FUTMBD44115	1
	BD Liner 1.2mm - 1.6mm 4.5m (15ft)	44215	FUTMBD44215	1
	BD Liner 1.2mm - 1.6mm 4.5m (15ft)	44215X Aluminium	FUTMBD44215X	1



### Tops MIG Torches & Welding Accessories

The hobbyist's welding torch and accessories

Description	Code	Pack
<b>Tops MIG Torches</b>		
Tops 100V MIG Torch	TRMMA428	1
Tops 140V MIG Torch	TRMMA429	1
<b>Main</b>		
Swan Neck 100V	TRMMF191	1
Swan Neck 140V	TRMMF190	1
<b>Nozzles</b>		
Conical Nozzle	FUTMTOPSNOZ	10
<b>Contact tips</b>		
100V M5X18 - 0.6mm	FUTMTOPS06	20
100VM5X18 - 0.8mm	FUTMTOPS08	20
100VM5X18 - 1.0mm	FUTMTOPS10	20

### Disposable Gas Cylinders

Handy disposable welding gas cylinder from the quality Futuris range



Code	Description	Pack
070508	Disposable Gas Cylinder - Argon 60Litres	12
070509	Disposable Gas Cylinder - Argon/CO2 Mix 10 Litres	12
070512	Disposable Gas Cylinder - CO2 390g	12

### Mini Mig Adaptor & Conversion Hose Assembly



Adaptor  
070571



- Converts your small MIG machine gas supply from a disposable gas cylinder to a full size refillable professional bottle
- Available in two versions: one adaptor fitting only to use where the machine has enough extra gas hose to reach the regulator, and one adaptor fitted to a 1.5m gas extension hose to allow for the extra height of professional bottles.

Code	Description	Pack
FUT993705	Mini MIG Conversion Hose Assembly	1
070571	Mini MIG Adaptor	1

### Mini MIG Regulator



- For use with Futuris disposable gas cylinders on small MIG & TIG machines. 1/8" BSP inlet bottle fitting
- 1/8" BSP inlet bottle fitting

Code	Description	Pack
070570	Mini MIG Regulator	1

### Multi-Purpose MIG Pliers



- Designed especially for CO<sub>2</sub> welding torches
- PVC dipped handles
- 200mm long

Code	Description	Pack
FUTMIG-PLIERS	Multi-Purpose MIG Pliers	1

### Futuris Tip-Dip Paste



- Prevents adhesion of spatter on the welding nozzle, prolonging working life
- Non-flammable, non-toxic & solvent free

Code	Description	Pack
FUT529-646	Tip-Dip Paste	12

### Weldaid - MIG Wire Treatment Pads & Liquid



- Lube-Matic products are engineered to reduce tip and liner wear, burnback, wire jams, and to promote smoother arc feed. The solution is to clean and lubricate the wire at the time of the weld. By doing this, the wire, tips, and liners realize a 60% reduction in wire drag—providing long life and smooth arc feed. Cuts rust and dirt. Pads provide concentric cleaning, and provides the best solution when used together.

Wire drag is caused by poor wire feed. Lube-Matic pads and liquid help keep liners free of unwanted build-up and deposits inside the liner that cause wire drag. The result is an imperfect and unstable weld. Use of Lube-Matic pads will also reduce burnbacks by at least 50%

Code	Description	Pack
WAP17007040	Lube-Matic Wire Kleener and Lubricant 5oz (142gms)	1
WAP17007060	Lube-Matic (Pre-treated) Wire Lube Pads (Pack of 6) Black	1
WAP17007061	Lube-Matic Wire Kleener Pads (Pack of 6) Red	1
WAP17007094	Weldaid Nozzle Gel - Heavy Duty 32oz	1

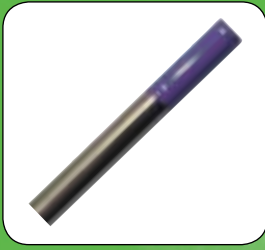

# TIG Welding ▶▶

TIG Torches Air Cooled - WP9 Weldcraft® Style	68
TIG Consumables - WP9 Weldcraft® Style	69
TIG Torches Air Cooled - WP17 Weldcraft® Style	70
TIG Consumables - WP17 Weldcraft® Style	71
TIG Torches Air Cooled - WP26 Weldcraft® Style	72
TIG Consumables - WP26 Weldcraft® Style	73
TIG Torches Water Cooled - WP18 Weldcraft® Style	74
TIG Torch Consumables - WP18 Weldcraft® Style	75
TIG Torches Water Cooled - WP20 Weldcraft® Style	76
TIG Torch Consumables - WP20 Weldcraft® Style	77
TIG Tungsten Electrodes	78
TIG Welding Accessories	79

# ▶▶ TIG Welding

## TIG Torches Air Cooled - WP9 Weldcraft® Style

### WP9 Air Cooled - Torch Packages

- Versatile and lightweight for thin gauge material
- Quick release tungsten adjustment
- Parts interchangeable with WP-20, WP-20P and WP-25 models

Technical Data	
Cooling	Air cooled
Wire Ø mm	0.6 - 1.0mm
Duty Cycle 60%	180A CO <sub>2</sub> 150A Mixed Gases



Description	Length	Cable	Weldcraft® Style Handle	Ergo Style Handle	Pack
<b>FF-T9 TIG Welding Torches</b>					
FF-T9 Scratch Start	4m	Mono	FUTT9-4		1
FF-T9 Pencil	4m		FUTT9P-4		1
FF-T9 Valved	4m		FUTT9V-4		1
FF-T9 Valved	8m		FUTT9V-8		1
FF-T9 Switched/Sheathed	4m		FUTT9-4-MSWSH	FUTT9-4-MSWSH-E	1
FF-T9 Switched/Sheathed	8m		FUTT9-8-MSWSH	FUTT9-8-MSWSH-E	1
FF-T9 Flexi Switched/Sheathed	4m		FUTT9F-4-MSWSH	FUTT9F-4-MSWSH-E	1
FF-T9 Flexi Switched/Sheathed	8m		FUTT9F-8-MSWSH	FUTT9F-8-MSWSH-E	1
FF-T9 Valved Switched/Sheathed	4m		FUTT9V-4-MSWSH		1

### 9 Air Cooled - Spares Breakdown

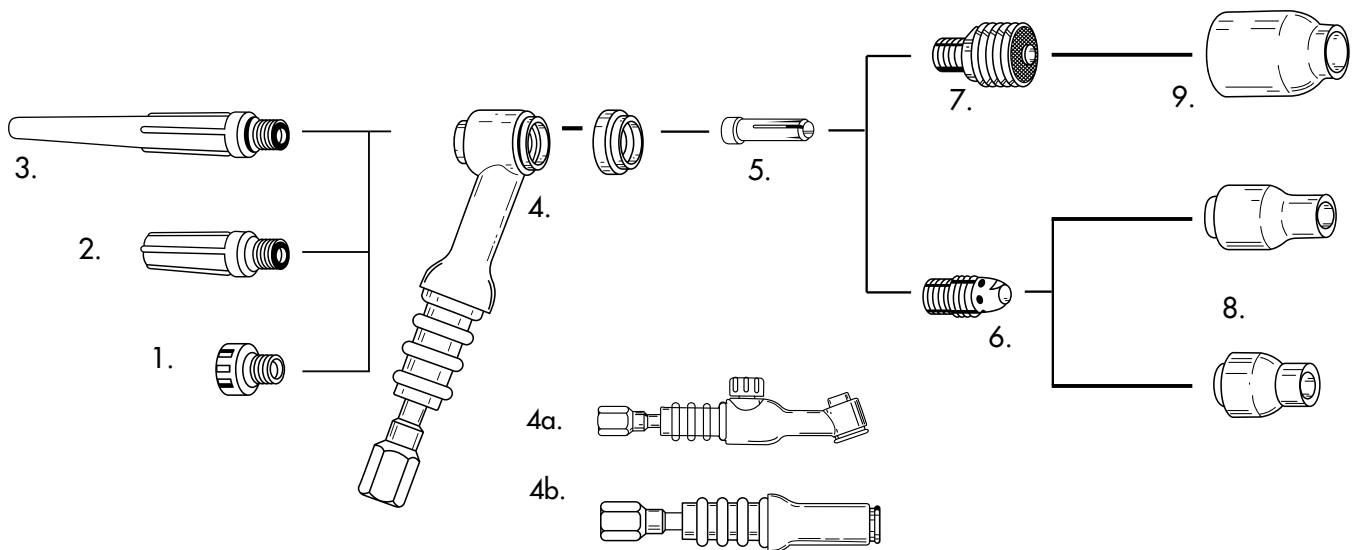

EN 60974-7

### WP9 Air Cooled - Spares

Key	Description	Electrode Diameter/Size	Code	Pack	
1.	Back Cap with O Ring Short 41V33		FUTT41V33	1	
2.	Back Caps	Back Cap with O Ring Medium 41V35	FUTT41V35	1	
3.		Back Cap with O Ring Long 41V24	FUTT41V24	1	
4.	Torch Heads	Standard Torch Head - 9	FUTT9	1	
4.		Flexi Torch Head - 9F	FUTT9F	1	
4a.		Flexi-Valved Torch Head - 9FV	FUTT9FV	1	
4b.		Pencil Torch Head - 9P	FUTT9P	1	
5.	Collets	Collet 13N21	1.0	FUTT13N21	5
		Collet 13N22	1.6	FUTT13N22	5
		Collet 13N23	2.4	FUTT13N23	5
		Collet 13N24	3.2	FUTT13N24	5
		Collet 13N21L (not shown)	1.0	FUTT13N21L	5
6.	Collet Body	Collet Body 13N26	1.0	FUTT13N26	5
		Collet Body 13N27	1.6	FUTT13N27	5
		Collet Body 13N28	2.4	FUTT13N28	5
		Collet Body 13N29	3.2	FUTT13N29	5
7.	Gas Lens Bodies	Gas Lens Collet Body 45V42	1.0	FUTT45V42	1
		Gas Lens Collet Body 45V43	1.6	FUTT45V43	1
		Gas Lens Collet Body 45V44	2.4	FUTT45V44	1
		Gas Lens Collet Body 45V45	3.2	FUTT45V45	1
8.	Ceramic Cups	Ceramic Cup 13N08 Ø 6.4mm	4	FUTT13N08	10
		Ceramic Cup 13N09 Ø 8.0mm	5	FUTT13N09	10
		Ceramic Cup 13N10 Ø 9.8mm	6	FUTT13N10	10
		Ceramic Cup 13N11 Ø 11.2mm	7	FUTT13N11	10
		Ceramic Cup 13N12 Ø 12.7mm	8	FUTT13N12	10
		Ceramic Cup 13N13 Ø 15.7mm	10	FUTT13N13	10
9.	Gas Lens Ceramic Cups	Gas Lens Ceramic Cup 53N58 Ø 6.4mm	4	FUTT53N58	10
		Gas Lens Ceramic Cup 53N59 Ø 8.0mm	5	FUTT53N59	10
		Gas Lens Ceramic Cup 53N60 Ø 9.8mm	6	FUTT53N60	10
		Gas Lens Ceramic Cup 53N61 Ø 11.2mm	7	FUTT53N61	10
		Gas Lens Ceramic Cup 53N61S Ø 12.7mm	8	FUTT53N61S	10

# ▶▶ TIG Welding

## TIG Torches Air Cooled - WP17 Weldcraft® Style

### WP17 Air Cooled - Torch Packages

- High capacity for thin to medium gauge materials
- Compact and durable for field welding applications. Available with rigid or flexible neck; with or without fingertip gas control valve
- Heavy duty two-piece power cable and ribbed handle as standard
- Parts are interchangeable with WP-18, WP-26 and WP-26V models

Technical Data	
Cooling	Air cooled
Wire Ø mm	0.6 - 1.0mm
Duty Cycle 60%	180A CO <sub>2</sub> 150A Mixed Gases



Description	Length	Weldcraft® Style Handle	Ergo Style Handle	Pack
<b>FF-T17 TIG Welding Torches</b>				
FF-T17 - 4m	4m	FUTT17-4		1
FF-T17 Valved Scratch Start - 4m	4m	FUTT17V-4		1
FF-T17 Valved 2-Piece - 4m	4m	FUTT17V-4-2		1
FF-T17 Valved Scratch Start - 8m	8m	FUTT17V-8		1
FF-T17 Switched/Sheathed - 4m	4m	FUTT17-4-MSWSH	FUTT17-4-MSWSH-E	1
FF-T17 Switched/Sheathed - 8m	4m	FUTT17-8-MSWSH	FUTT17-8-MSWSH-E	1
FF-T17 Flexi Switched/Sheathed - 4m	4m	FUTT17F-4-MSWSH	FUTT17F-4-MSWSH-E	1
FF-T17 Flexi Switched/Sheathed - 8m	8m	FUTT17F-8-MSWSH	FUTT17F-8-MSWSH-E	1

### 9 Air Cooled - Spares Breakdown

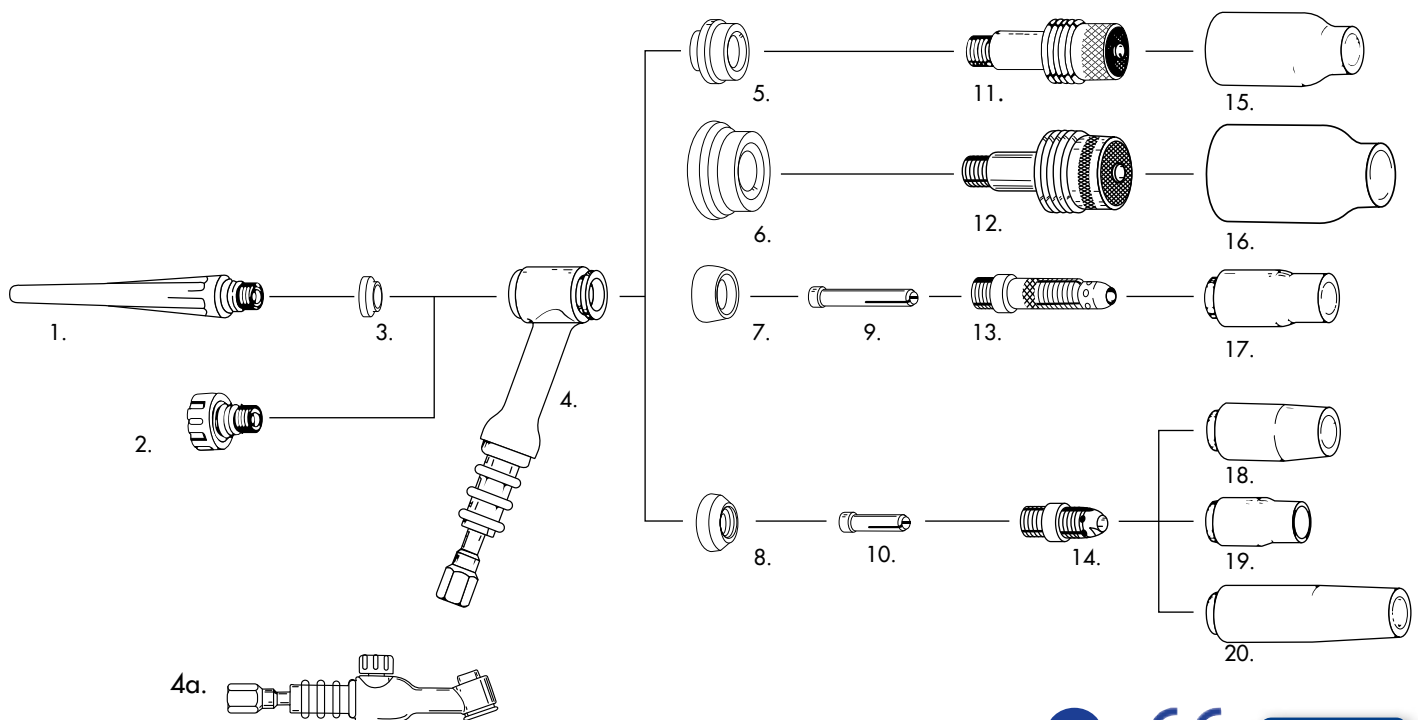

### WP17 Air Cooled - Spares

Key	Description	Electrode Diameter/Size	Code	Pack	
2.	Back Cap with O Ring Short 57Y04		FUTT57Y04	1	
1.	Back Caps & Head Spares	Back Cap With O Ring Long 57Y02	FUTT57Y02	1	
5.		Gas Lens Insulator 54N01	FUTT54N01	2	
7.		Cup Gasket 18CG	FUTT18CG	2	
4.	Torch Bodies	Standard Torch Head - 17	FUTT17	1	
4.		Flexi Torch Head - 17F	FUTT17F	1	
4a.		Flexi Valved Torch Head - 17FV	FUTT17FV	1	
4a.		Valved Torch Head - 17V	FUTT17V	1	
9.	Collets	Collet 10N22	1.0	FUTT10N22	5
		Collet 10N23	1.6	FUTT10N23	5
		Collet 10N24	2.4	FUTT10N24	5
		Collet 10N25	3.2	FUTT10N25	5
13.	Collet Bodies	Collet Body 10N30	1.0	FUTT10N30	5
		Collet Body 10N31	1.6	FUTT10N31	5
		Collet Body 10N32	2.4	FUTT10N32	5
		Collet Body 10N28	3.2	FUTT10N28	5
11. 12.	Gas Lens Collet Bodies	Gas Lens Collet Body 45V24	1.0	FUTT45V24	1
		Gas Lens Collet Body 45V25	1.6	FUTT45V25	1
		Gas Lens Collet Body 45V26	2.4	FUTT45V26	1
		Gas Lens Collet Body 45V27	3.2	FUTT45V27	1
		Gas Lens Collet Body 45V28	4.0	FUTT45V28	1
18. 19. 20.	Ceramic Cups	Ceramic Cup 10N50 Ø 6.4mm	4	FUTT10N50	10
		Ceramic Cup 10N49 Ø 8.0mm	5	FUTT10N49	10
		Ceramic Cup 10N48 Ø 9.8mm	6	FUTT10N48	10
		Ceramic Cup 10N47 Ø 11.2mm	7	FUTT10N47	10
		Ceramic Cup 10N46 Ø 12.7mm	8	FUTT10N46	10
		Ceramic Cup 10N45 Ø 15.7mm	10	FUTT10N45	10
		Ceramic Cup 10N44 Ø 19.0mm	12	FUTT10N44	10
15. 16. 17.	Gas Lens Ceramic Cups	Gas Lens Ceramic Cup 54N18 Ø 6.4mm	4	FUTT54N18	10
		Gas Lens Ceramic Cup 54N17 Ø 8.0mm	5	FUTT54N17	10
		Gas Lens Ceramic Cup 54N16 Ø 9.8mm	6	FUTT54N16	10
		Gas Lens Ceramic Cup 54N15 Ø 11.2mm	7	FUTT54N15	10
		Gas Lens Ceramic Cup 54N14 Ø 12.7mm	8	FUTT54N14	10
	Gas Lens Ceramic Cup 54N19 Ø 17.2mm	11	FUTT54N19	10	



# ▶▶ TIG Welding

## TIG Torches Air Cooled - WP26 Weldcraft® Style

### WP26 Air Cooled - Torch Packages

- Maximum capacity air cooled torch for continuous heavy-duty use
- Heavy copper construction for rugged field work
- Available with rigid or flexible neck, with or without fingertip gas control valve
- Heavy duty two-piece power cable and ribbed handle are standard
- Parts interchangeable with WP-18, WP-17 and WP-17V models

Technical Data	
Cooling	Air cooled
Wire Ø mm	0.6 - 1.0mm
Duty Cycle 60%	180A CO <sub>2</sub> 150A Mixed Gases



Description	Length	Weldcraft® Style Handle	Ergo Style Handle	Pack
<b>FF-T26 TIG Welding Torches</b>				
FF-T26 Switched/Sheathed - 4m	4m	FUTT26-4-MSWSH	FUTT26-4-MSWSH	1
FF-T26 Switched/Sheathed- 8m	8m	FUTT26-8-MSWSH	FUTT26-8-MSWSH	1
FF-T26 Flexi Switched/Sheathed - 4m	4m	FUTT26F-4-MSWSH	FUTT26F-4-MSWSH	1
FF-T26 Flexi Switched/Sheathed - 8m	8m	FUTT26F-8-MSWSH	FUTT26F-8-MSWSH	1
FF-T26 Flexi Valved Mono Switched/ Sheathed - 8m	8m	FUTT26FV-8-MSWS		1
FF-T26 Valved Scratch Start - 4m	4m	FUTT26V-4		1
FF-T26 Valved Scratch Start - 8m	8m	FUTT26V-8		1

### 26 Air Cooled - Spares Breakdown

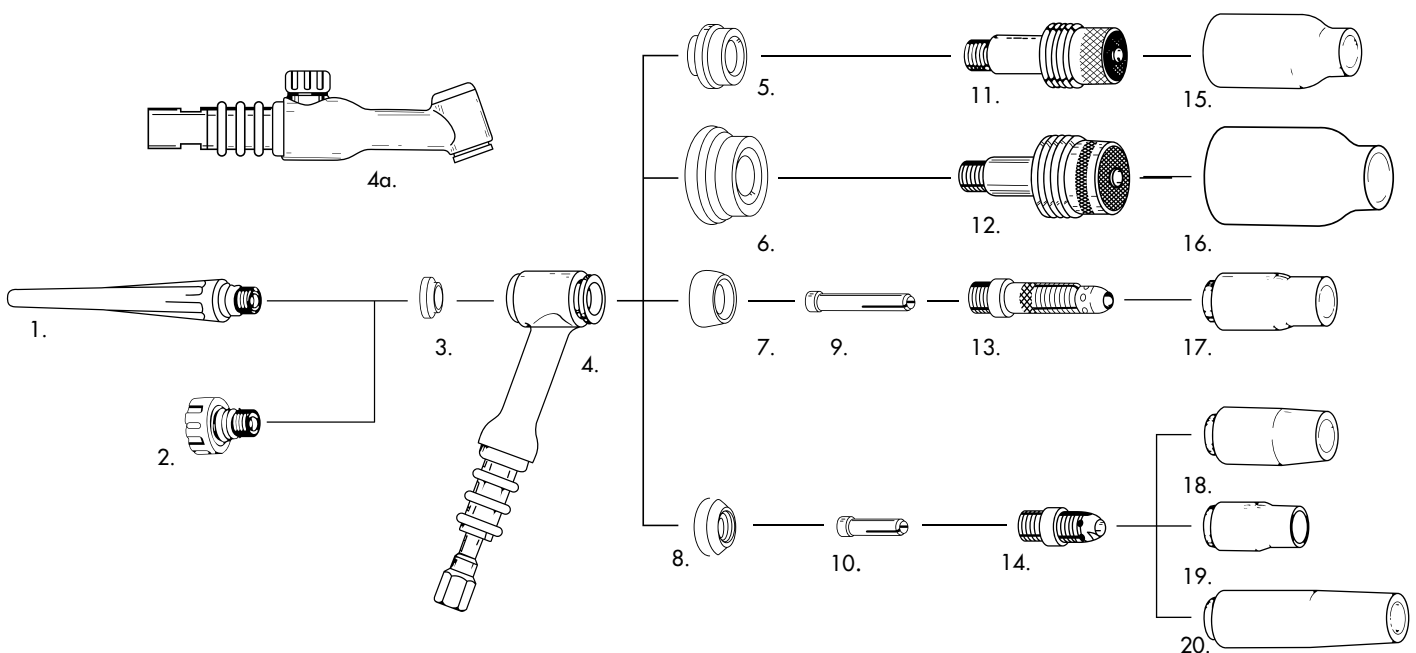

### WP26 Air Cooled - Spares

Key	Description	Electrode Diameter/Size	Code	Pack
2.	Back Cap With O Ring Short 57Y04		FUTT57Y04	1
1.	Back Caps & Head Spares		FUTT57Y02	1
5.			FUTT54N01	2
7.			FUTT18CG	2
4	Standard Torch Head		FUTT26	1
4.	Torch Bodies		FUTT26F	1
4a.			FUTT26FV	1
4a.			FUTT26V	1
9.	Collets	1.0	FUTT10N22	5
		1.6	FUTT10N23	5
		2.4	FUTT10N24	5
		3.2	FUTT10N25	5
13.	Collet Bodies	1.0	FUTT10N30	5
		1.6	FUTT10N31	5
		2.4	FUTT10N32	5
		3.2	FUTT10N28	5
11. 12.	Gas Lens Collet Bodies	1.0	FUTT45V24	1
		1.6	FUTT45V25	1
		2.4	FUTT45V26	1
		3.2	FUTT45V27	1
		4.0	FUTT45V28	1
18.	Ceramic Cups	4	FUTT10N50	10
		5	FUTT10N49	10
		6	FUTT10N48	10
19.		7	FUTT10N47	10
20.		8	FUTT10N46	10
		10	FUTT10N45	10
		12	FUTT10N44	10
15.	Gas Lens Ceramic Cups	4	FUTT54N18	10
		5	FUTT54N17	10
16.		6	FUTT54N16	10
17.		7	FUTT54N15	10
		8	FUTT54N14	10
		11	FUTT54N19	10

# ▶▶ TIG Welding

## TIG Torches Water Cooled - WP18 Weldcraft® Style

### WP18 Water Cooled - Torch Packages

- Highly durable torches for continuous use
- Heavy-duty rugged production torch for continuous duty to 350 amps
- Parts interchangeable with WP-17, WP-17V, WP26 and WP-26V models

Technical Data	
Cooling	Air cooled
Wire Ø mm	0.6 - 1.0mm
Duty Cycle 60%	180A CO <sub>2</sub> 150A Mixed Gases



Description	Length	Weldcraft® Style Handle	Ergo Style Handle	Pack
<b>FF-T18 TIG Welding Torche Package</b>				
FF-T18 Water Cooled Switched/Sheathed - 4m	4m	FUTT18-4-SWSH	FUTT18-4-SWSHE	1
FF-T18 Water Cooled Switched/Sheathed- 8m	8m	FUTT18-8-SWSH	FUTT18-8-SWSHE	1
FF-T18 Water Cooled Flexi Switched/Sheathed - 4m	4m	FUTT18F-4-SWSH	FUTT18F-4-SWSHE	1
FF-T18 Water Cooled Flexi Switched/Sheathed - 8m	8m	FUTT18F-8-SWSH	FUTT18F-8-SWSHE	1
FF-T18 Super Cool Switched/Sheathed - 4m	4m	FUTT18SC-4-SWSH		1
FF-T18 Super Cool Switched/Sheathed - 8m	8m	FUTT18SC-4-SWSH		1

### 18 Water Cooled - Spares Breakdown

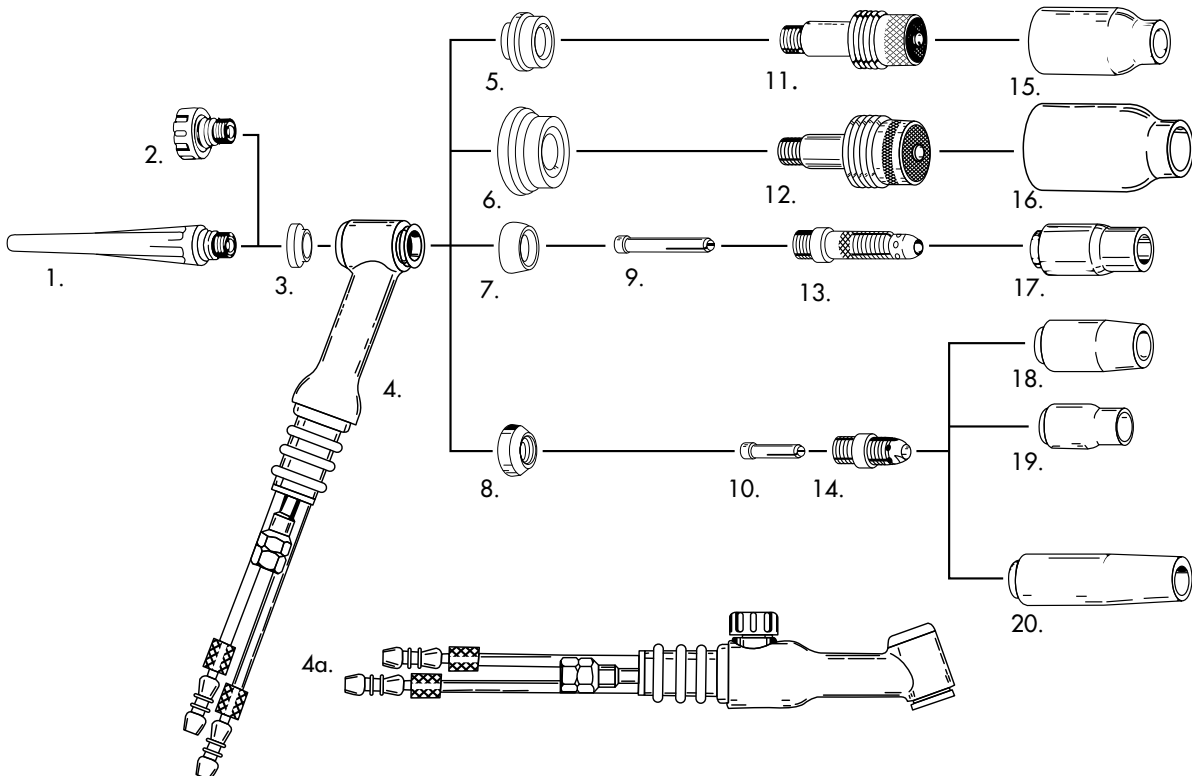

EN 60974-7

### WP18 Water Cooled - Spares

Key	Description	Electrode Diameter/ Size	Code	Pack	
2.	Back Cap With O Ring Short 57Y04		FUTT57Y04	1	
1.	Back Caps & Head Spares	Back Cap With O Ring Long 57Y02	FUTT57Y02	1	
5.		Gas Lens Insulator 54N01	FUTT54N01	2	
7.		Cup Gasket 18CG	FUTT18CG	2	
4.	Torch Bodies	Standard Torch Head - 18	FUTT18	1	
4.		Flexi Torch Head - 18F	FUTT18F	1	
9.	Collets	Collet 10N22	1.0	FUTT10N22	5
		Collet 10N23	1.6	FUTT10N23	5
		Collet 10N24	2.4	FUTT10N24	5
		Collet 10N25	3.2	FUTT10N25	5
		Collet 54N20	4.0	FUTT54N20	5
13.	Collet Bodies	Collet Body 10N30	1.0	FUTT10N30	5
		Collet Body 10N31	1.6	FUTT10N31	5
		Collet Body 10N32	2.4	FUTT10N32	5
		Collet Body 10N28	3.2	FUTT10N28	5
11.	Gas Lens Collet Bodies	Gas Lens Collet Body 45V24	1.0	FUTT45V24	1
		Gas Lens Collet Body 45V25	1.6	FUTT45V25	1
12.		Gas Lens Collet Body 45V26	2.4	FUTT45V26	1
		Gas Lens Collet Body 45V27	3.2	FUTT45V27	1
		Gas Lens Collet Body 45V28	4.0	FUTT45V28	1
18.	Ceramic Cups	Ceramic Cup 10N50 Ø 6.4mm	4	FUTT10N50	10
		Ceramic Cup 10N49 Ø 8.0mm	5	FUTT10N49	10
		Ceramic Cup 10N48 Ø 9.8mm	6	FUTT10N48	10
19.		Ceramic Cup 10N47 Ø 11.2mm	7	FUTT10N47	10
20.		Ceramic Cup 10N46 Ø 12.7mm	8	FUTT10N46	10
		Ceramic Cup 10N45 Ø 15.7mm	10	FUTT10N45	10
		Ceramic Cup 10N44 Ø 19.0mm	12	FUTT10N44	10
15.	Gas Lens Ceramic Cups	Gas Lens Ceramic Cup 54N18 Ø 6.4mm	4	FUTT54N18	10
		Gas Lens Ceramic Cup 54N17 Ø 8.0mm	5	FUTT54N17	10
16.		Gas Lens Ceramic Cup 54N16 Ø 9.8mm	6	FUTT54N16	10
17.		Gas Lens Ceramic Cup 54N15 Ø 11.2mm	7	FUTT54N15	10
		Gas Lens Ceramic Cup 54N14 Ø 17.2mm	8	FUTT54N14	10

# ▶▶ TIG Welding

## TIG Torches Water Cooled - WP20 Weldcraft® Style

### WP20 Water Cooled - Torch Packages

- Lightweight, small durable torches
- Compact and well-balanced for general duty use
- Parts interchangeable with WP-9, WP-9P and WP-25 models

Technical Data	
Cooling	Air cooled
Wire Ø mm	0.6 - 1.0mm
Duty Cycle 60%	180A CO <sub>2</sub> 150A Mixed Gases



Description	Length	Weldcraft® Style Handle	Ergo Style Handle	Pack
<b>FF-T20 TIG Welding Torches</b>				
FF-T20 Water Cooled Switched/Sheathed	4m	FUTT20-4-SWSH	FUTT20-4-SWSHE	1
FF-T20 Water Cooled Switched/Sheathed	8m	FUTT20-8-SWSH	FUTT20-8-SWSHE	1
FF-T20 Water Cooled Flexi Switched/Sheathed	4m	FUTT20F-4-SWSH		1
FF-T20 Water Cooled Flexi Switched/Sheathed	8m	FUTT20F-8-SWSH		1

### 20 Water Cooled - Spares Breakdown

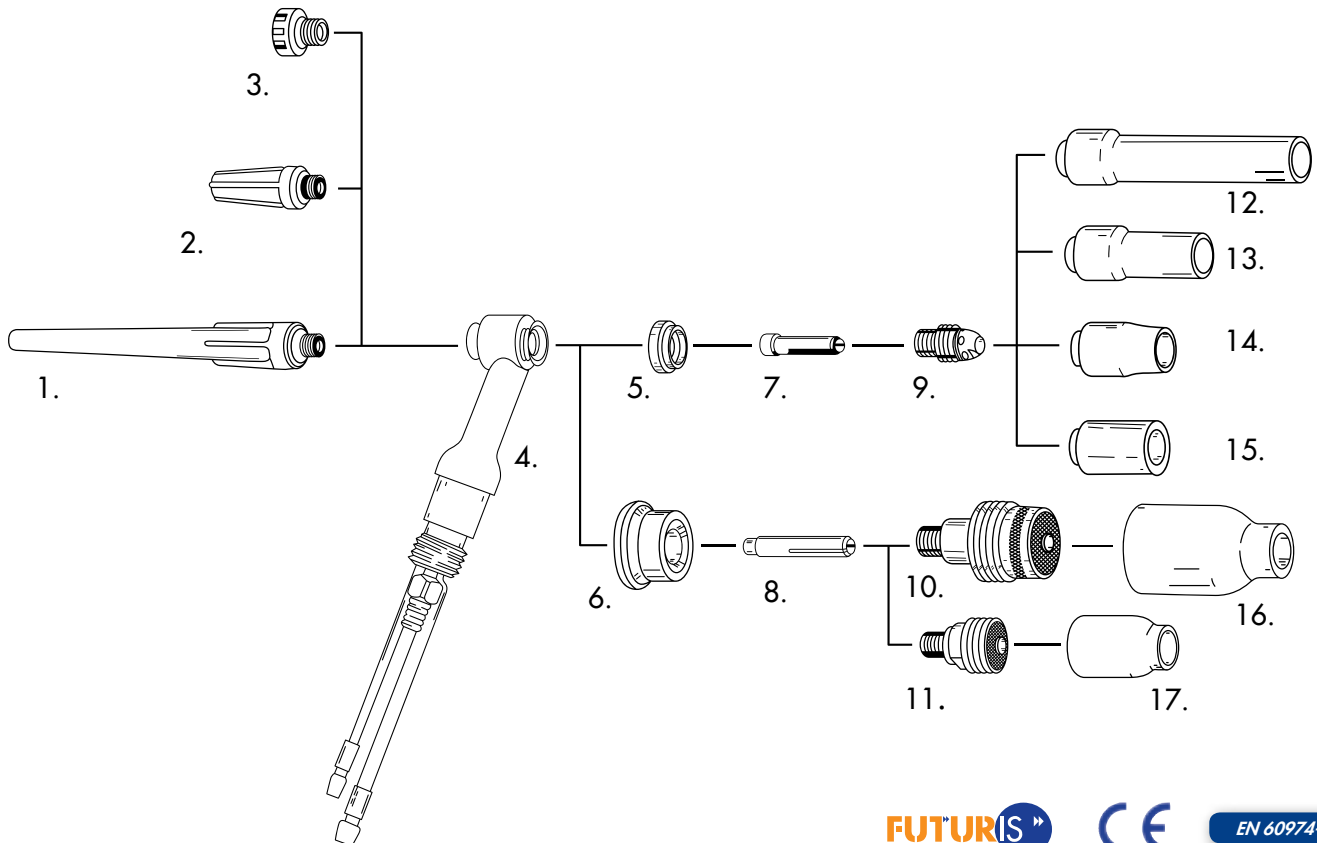

EN 60974-7

### WP20 Water Cooled - Spares

Key		Description	Electrode Diameter/Size	Code	Pack
3.		Back Cap With O Ring Short 41V33		FUTT41V33	1
2.	Back Caps	Back Cap With O Ring Medium 41V35		FUTT41V35	1
1.		Back Cap With O Ring Long 41V24		FUTT41V24	1
4.	Torch Bodies	Standard Torch Head - 20		FUTT20	1
		Flexi Torch head - 20F		FUTT20F	1
7.	Collets	Collet 13N21	1.0	FUTT13N21	5
		Collet 13N22	1.6	FUTT13N22	5
		Collet 13N23	2.4	FUTT13N23	5
		Collet 13N24	3.2	FUTT13N24	5
		Collet 13N21L (not shown)	1.0	FUTT13N21L	5
9.	Collet Bodies	Collet Body 13N26	1.0	FUTT13N26	5
		Collet Body 13N27	1.6	FUTT13N27	5
		Collet Body 13N28	2.4	FUTT13N28	5
		Collet Body 13N29	3.2	FUTT13N29	5
10.	Gas Lens	Gas Lens Collet Body 45V42	1.0	FUTT45V42	1
		Gas Lens Collet Body 45V43	1.6	FUTT45V43	1
11.	Collet Bodies	Gas Lens Collet Body 45V44	2.4	FUTT45V44	1
		Gas Lens Collet Body 45V45	3.2	FUTT45V45	1
12.		Ceramic Cup 13N08 Ø 6.4mm	4	FUTT13N08	10
		Ceramic Cup 13N09 Ø 8.0mm	5	FUTT13N09	10
13.	Ceramic	Ceramic Cup 13N10 Ø 9.8mm	6	FUTT13N10	10
14.	Cups	Ceramic Cup 13N11 Ø 11.2mm	7	FUTT13N11	10
15.		Ceramic Cup 13N12 Ø 12.7mm	8	FUTT13N12	10
		Ceramic Cup 13N13 Ø 15.7mm	10	FUTT13N13	10
16.	Gas Lens	Gas Lens Ceramic Cup 53N58 Ø 6.4mm	4	FUTT53N58	10
		Gas Lens Ceramic Cup 53N59 Ø 8.0mm	5	FUTT53N59	10
17.	Ceramic	Gas Lens Ceramic Cup 53N60 Ø 9.8mm	6	FUTT53N60	10
	Cups	Gas Lens Ceramic Cup 53N61 Ø 11.2mm	7	FUTT53N61	10
		Gas Lens Ceramic Cup 53N61S Ø 12.7mm	8	FUTT53N61S	10

### Tungsten Electrodes

	Description		Code	Pack
	<b>Multiple Strike "Bestrike"</b>			
	1.6 x 150mm		090112	10
	2.4 x 150mm		090114	10
	3.2 x 150mm		090116	10
	4.0 x 150mm		090117	10
	<b>Lanthanated 2% WL20</b>			
	1.6 x 150mm		090143	10
	2.4 x 150mm		090145	10
	3.2 x 150mm		090147	10
	4.0 x 150mm		090148	10
	<b>Thoriated 2% WT20</b>			
	1.0 x 150mm		090131	10
	1.6 x 150mm	Designed for DC welding, they maintain a sharpened tip configuration during welding, desirable for the welding of steels, nickel alloys & most alloys other than aluminium & magnesium.	090133	10
	2.4 x 150mm		090134	10
	3.2 x 150mm		090135	10
	4.0 x 150mm		090136	10
	4.8 x 150mm		090137	10
	<b>Zirconiated 0.8% WZ08</b>			
	1.0 x 150mm		090161	10
	1.6 x 150mm	These electrodes have characteristics that fall between pure and thoriated electrodes and are designed for AC welding of aluminium & magnesium.	090163	10
	2.4 x 150mm		090164	10
	3.2 x 150mm		090165	10
	4.0 x 150mm		090166	10
	4.8 x 150mm		090167	10
	<b>Ceriated 2% WC20</b>			
	1.6 x 150mm	Designed for both AC and DC welding, ceriated electrodes are characterised by ease of starting, good arc stability and high current capacity.	090193	10
	2.4 x 150mm		090194	10
	3.2 x 150mm		090195	10
	<b>Non-Radioactive FF3</b>			
	1.6 x 150mm	Futuris electrode tungstens unique to Weldspares.	090153	10
	2.4 x 150mm		090154	10
	3.2 x 150mm		090155	10

### Weldas Leather TIG Torch Covers



- Lightbrown Leather Zipper Cover
- Sewn with KEVLAR thread
- Used to bind water cooled TIG cable hoses without the need for cable ties or tape that can restrict water flow
- Can also be used for protection on all welding and plasma cutting torch cables
- Two lengths available 3m & 6.7 m

Code	Description
WEL44-3010Z	Weldas Cable Cover 22mm 3.0m
WEL44-3022Z	Weldas Cable Cover 22mm 6.7m



WELDAS®





# Plasma Cutting ▶

Binzel® Style Plasma Spares	82-83
Cebora® Style Plasma Spares	84-87
Hypertherm® Style Plasma Spares	88-91
Thermal Dynamics® Style Plasma Spares	92-95
Trafimet® Style Plasma Spares	96-99

Futuris® Plasma torches and replacement parts are not genuine OEM products. Reference to OEM parts is for ease of use only.



# ►► Plasma Cutting Binzel® Style Plasma Spares

## PSB30

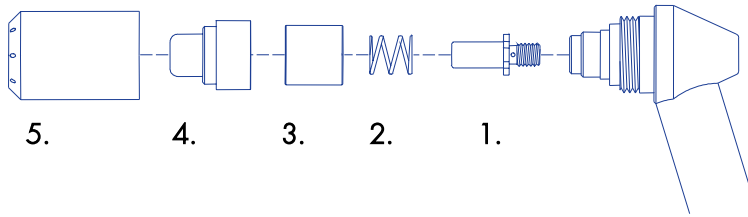

FUTURIS®

Key	Description	Code
1	Electrode 14.5mm - Zr	FUTPBZ-744.0014
	Electrode 15mm - Zr	FUTPBZ-744.0013
	Electrode 15.5mm - Zr	FUTPBZ-744.0012
2	Spring	FUTPBZ-744.0024
3	Insulator HF	FUTPBZ-744.0076
4	Cutting Tip 1.0mm	FUTPBZ-744.0010
	Cutting Tip 1.2mm	FUTPBZ-744.0061
5	Air Diffuser, insulator	FUTPBZ-744.0011

## PSB31

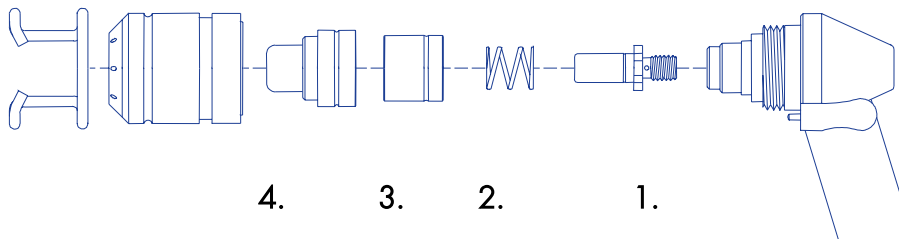

FUTURIS®

Key	Description	Code
1	Electrode 15.5mm - Zr	FUTPBZ-742.0016
	Electrode 16mm - Zr	FUTPBZ-742.0017
	Electrode 16.5mm - Zr	FUTPBZ-742.0018
2	Spring	FUTPBZ-744.0024
3	Spring Sleeve	FUTPBZ-742.0025
4	Cutting Tip 1.0mm	FUTPBZ-742.0011
	Cutting Tip 1.2mm	FUTPBZ-742.0026

PSB 60 / 80 / 121

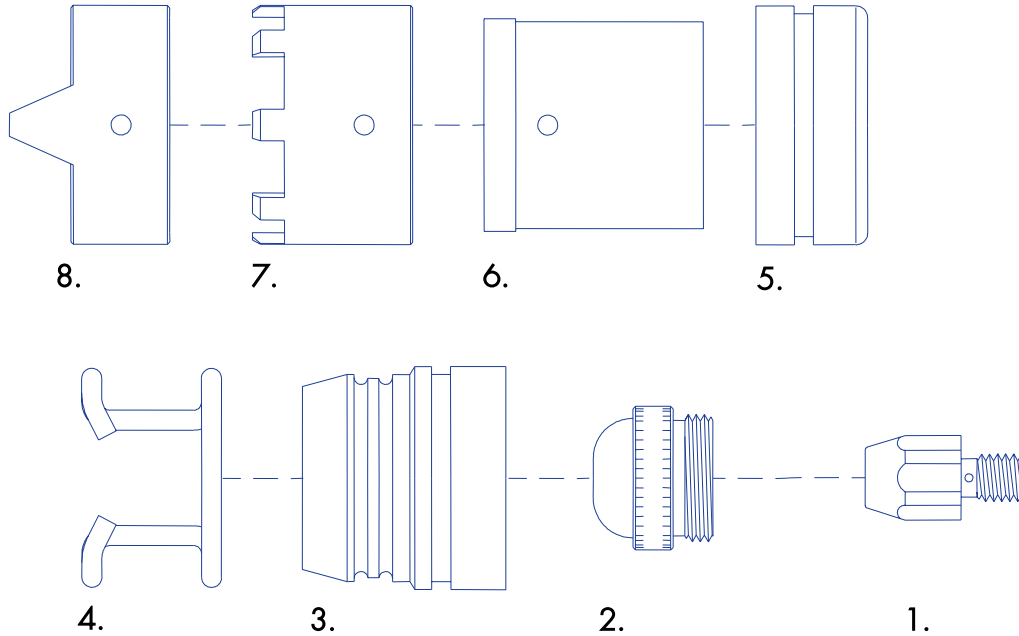

**FUTURIS** ▶

Key	Decription	Code
1	Electrode Zirconium	FUTPBZ-743.0077
	Electrode Hafnium	FUTPBZ-743.0067
2	Cutting Tip 1.0mm	FUTPBZ-743.0122
	Cutting Tip 1.5mm	FUTPBZ-743.0132
	Cutting Tip 1.8mm	FUTPBZ-743.0209
3	Spring Support	FUTPBZ-743.0131
4	Spacer Spring	FUTPBZ-743.0149
5	Distance Sleeve	FUTPBZ-743.0125
6	Distance Nozzle Support	FUTPBZ-743.0126
7	Crown Copper Nozzle	FUTPBZ-743.0127
8	Double Pointed Copper Nozzle	FUTPBZ-743.0168

# ▶▶ Plasma Cutting

## Cebora® Style Plasma Spares

Prof 35 HF / Prof 50

Art. 896

Art. 937

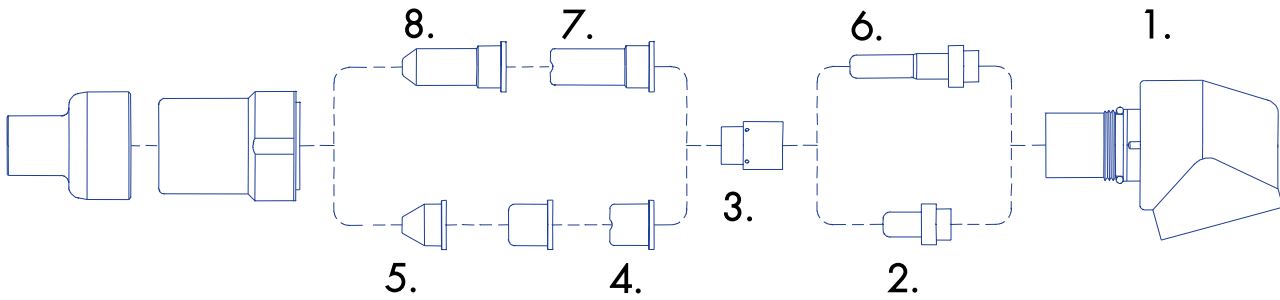

Key	Description	Code
1	Hand Torch Head	FUTPCB-C1352
2	Electrode Hafnium Insert	FUTPCB-C1521
	Electrode Zirconium Insert	FUTPCB-C1520
3	Swirl Ring	FUTPCB-C1510
4	Cutting Tip Flat 1.0mm	FUTPCB-C1304
	Cutting Tip Long Life 1.0mm	FUTPCB-C1396
5	Cutting Tip Conical 1.0mm	FUTPCB-C1305
6	Long Electrode Hafnium Insert	FUTPCB-C1518
	Long Electrode Zirconium Insert	FUTPCB-C1519
7	Long Cutting Tip 1.0mm	FUTPCB-C1370
	Long Cutting Tip Long Life 1.0mm	FUTPCB-C1395
8	Long Cutting Tip Conical 1.0mm	FUTPCB-C1306

### Power Sound 35 PC / Prof 36 / Prof 52 / Prof 70

Art. 292

Art. 938

Art. 940

Art. 941

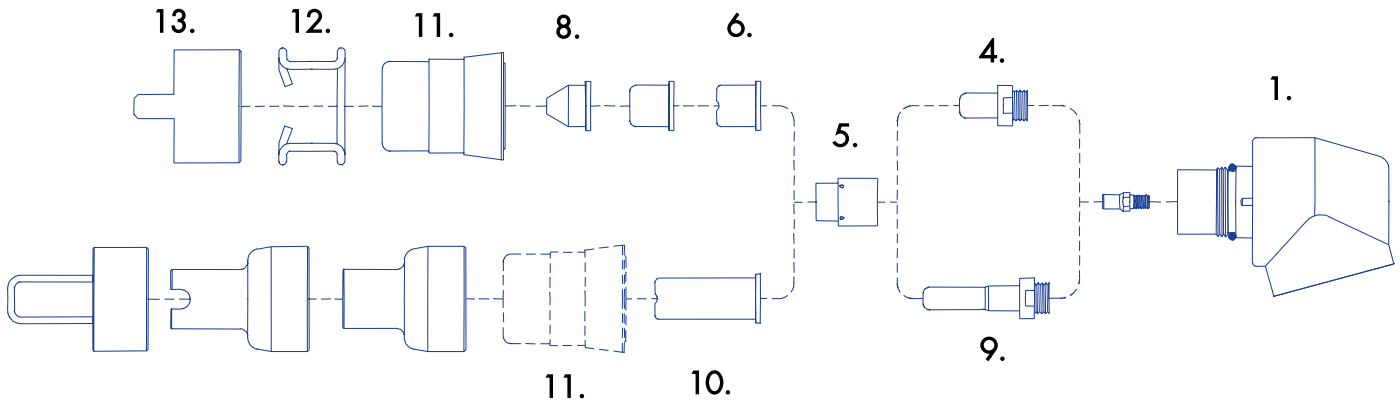

Key	Description	Code
1	Hand Torch Head	FUTPCB-C1351
4	Electrode Hafnium Insert	FUTPCB-C1402
5	Swirl Ring	FUTPCB-C1510
6	Cutting Tip Long Life 1.0mm	FUTPCB-C1396
	Cutting Tip 1.2mm	FUTPCB-C1308
	Cutting Tip Flat 1.0mm	FUTPCB-C1304
8	Cutting Tip Conical 1.0mm	FUTPCB-C1305
9	Long Electrode	FUTPCB-C1403
10	Long Cutting Tip Long Life 1.0mm	FUTPCB-C1395
11	Nozzle Retaining Cap	FUTPCB-C5710171
12	Spacer Spring	FUTPCB-C1394
13	Double Pointed Spacer	FUTPCB-C1405

# ▶▶ Plasma Cutting Cebora® Style Plasma Spares

Prof 90 / 92 / 120 / 122 / 150 / 152 / 162

Art. 942   Art. 943   Art. 945   Art. 946   Art. 950   Art. 951   Art. 952

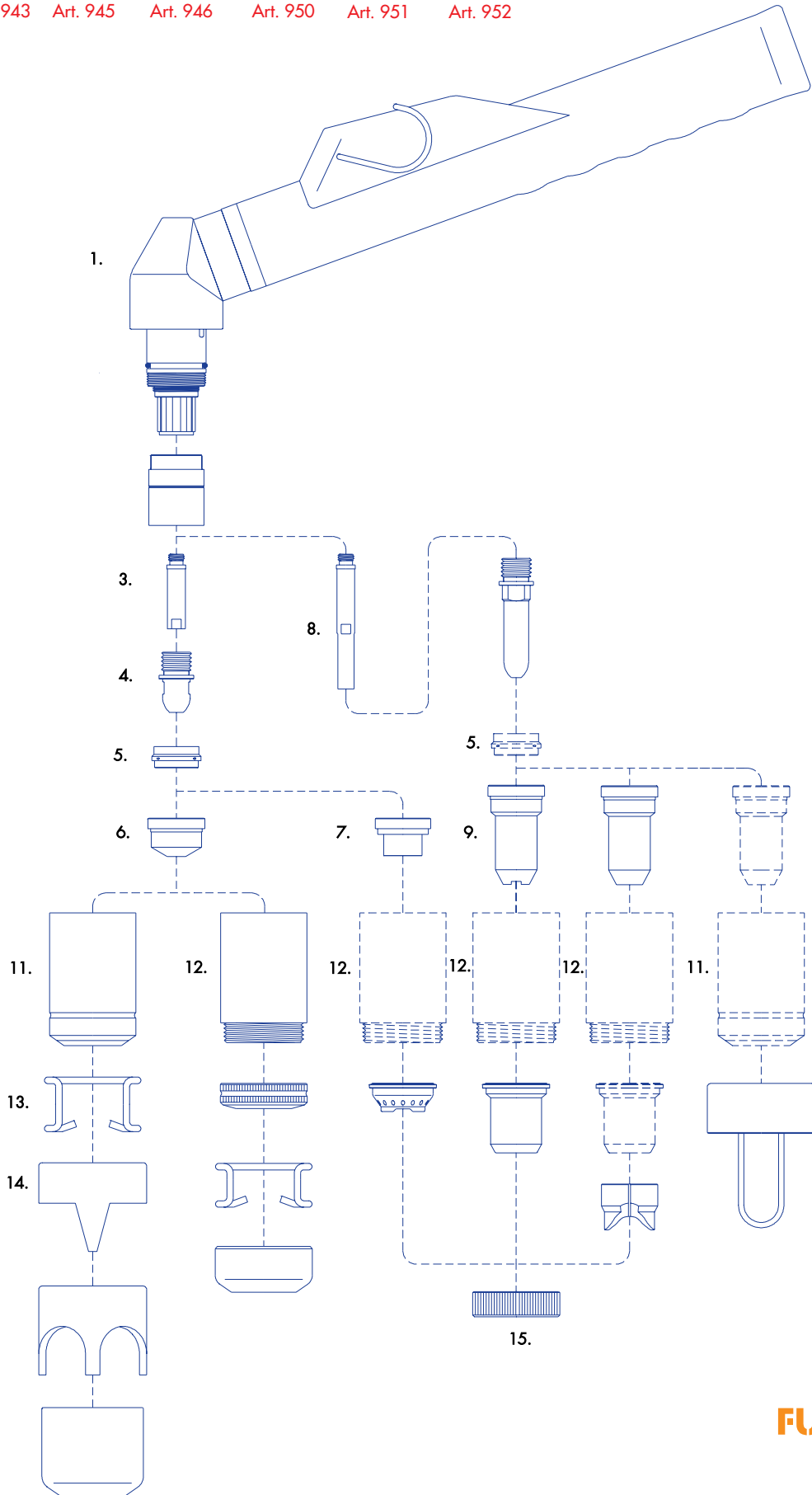

Prof 90 / 92 / 120 / 122 / 150 / 152 / 162

Key	Description	Code	
1	Hand Torch Head	FUTPCB-C1353	
3	Diffuser	FUTPCB-C1378	
4	Electrode	FUTPCB-C1376	
5	Swirl Ring	FUTPCB-C1377	
6	Cutting Tip Conical 1.1mm	FUTPCB-C1371	
	Cutting Tip Conical 1.35mm	FUTPCB-C1372	
	Cutting Tip Conical 1.6mm	FUTPCB-C1373	
	Cutting Tip Conical 1.8mm	FUTPCB-C1374	
	Gouging Tip 3.0mm	FUTPCB-C1375	
	7	Cutting Tip Flat 1.35mm	FUTPCB-C1390
		Cutting Tip Flat 1.6mm	FUTPCB-C1391
Cutting Tip Flat 1.8mm		FUTPCB-C1392	
8	Long Diffuser	FUTPCB-C1517	
9	Long Cutting Tip Max. 50A	FUTPCB-C1369	
11	Nozzle Retaining Cap	FUTPCB-C1389	
12	Contact Nozzle Retaining Cap	FUTPCB-C1393	
13	Spacer Spring	FUTPCB-C1386	
14	Double Point Spacer	FUTPCB-C1408	
15	Locking Nut	FUTPCB-P1516	

# ▶▶ Plasma Cutting Hypertherm® Style Plasma Spares

Max 200 / HT 2000

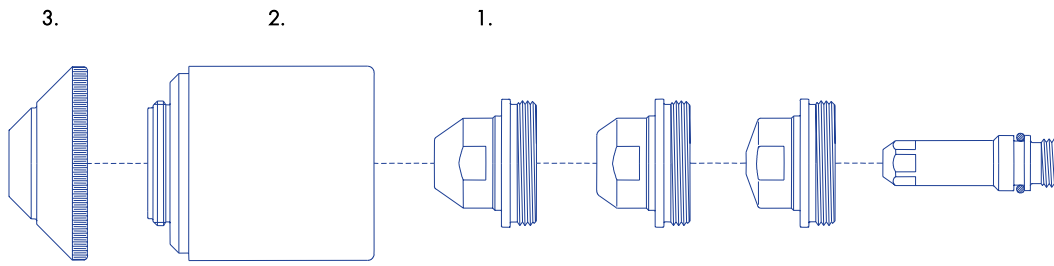

**FUTURIS** »

Key	Description	Code
1	Nozzle .082 - O <sub>2</sub> - 200A	FUTPHY-020605
2	Nozzle Retaining Cap	FUTPHY-020423
3	Shield Cap - Air, O <sub>2</sub> , N <sub>2</sub> , Ar/H - 200A	FUTPHY-020424

Max 20

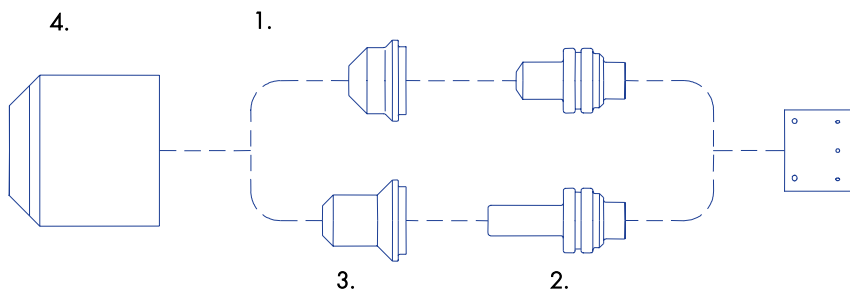

**FUTURIS** »

Key	Description	Code
1	Cutting Tip 0.73mm	FUTPHY-020299
2	Long Electrode	FUTPHY-020382
3	Long Cutting Tip 0.73mm	FUTPHY-020381
4	Nozzle Retaining Cap	FUTPHY-020218



Max 40

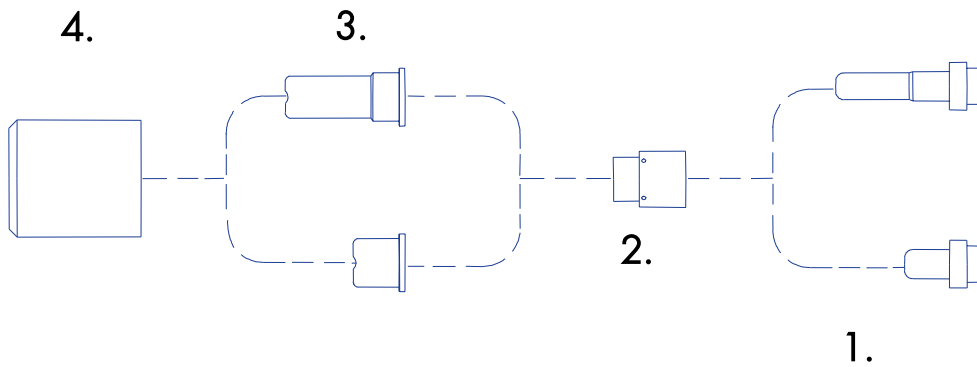

Key	Description	Code
1	Electrode	FUTPHY-020103
2	Swirl Ring	FUTPHY-020101
3	Cutting Tip - Hand Torch	FUTPHY-020115
4	Nozzle Retaining Cap	FUTPHY-020104

Max 40 CS / 42 / 43

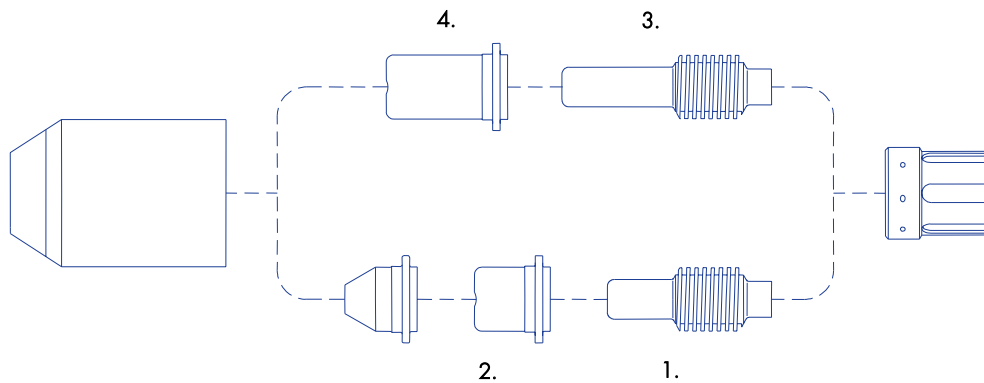

Key	Description	Code
1	Electrode - Replaces 020351	FUTPHY-120573
2	Cutting Tip 0.96mm	FUTPHY-020350
3	Long Electrode - Replaces 020547	FUTPHY-120574
4	Long Cutting Tip 0.96mm	FUTPHY-020546

# ▶▶ Plasma Cutting Hypertherm® Style Plasma Spares

Max 80 / 100

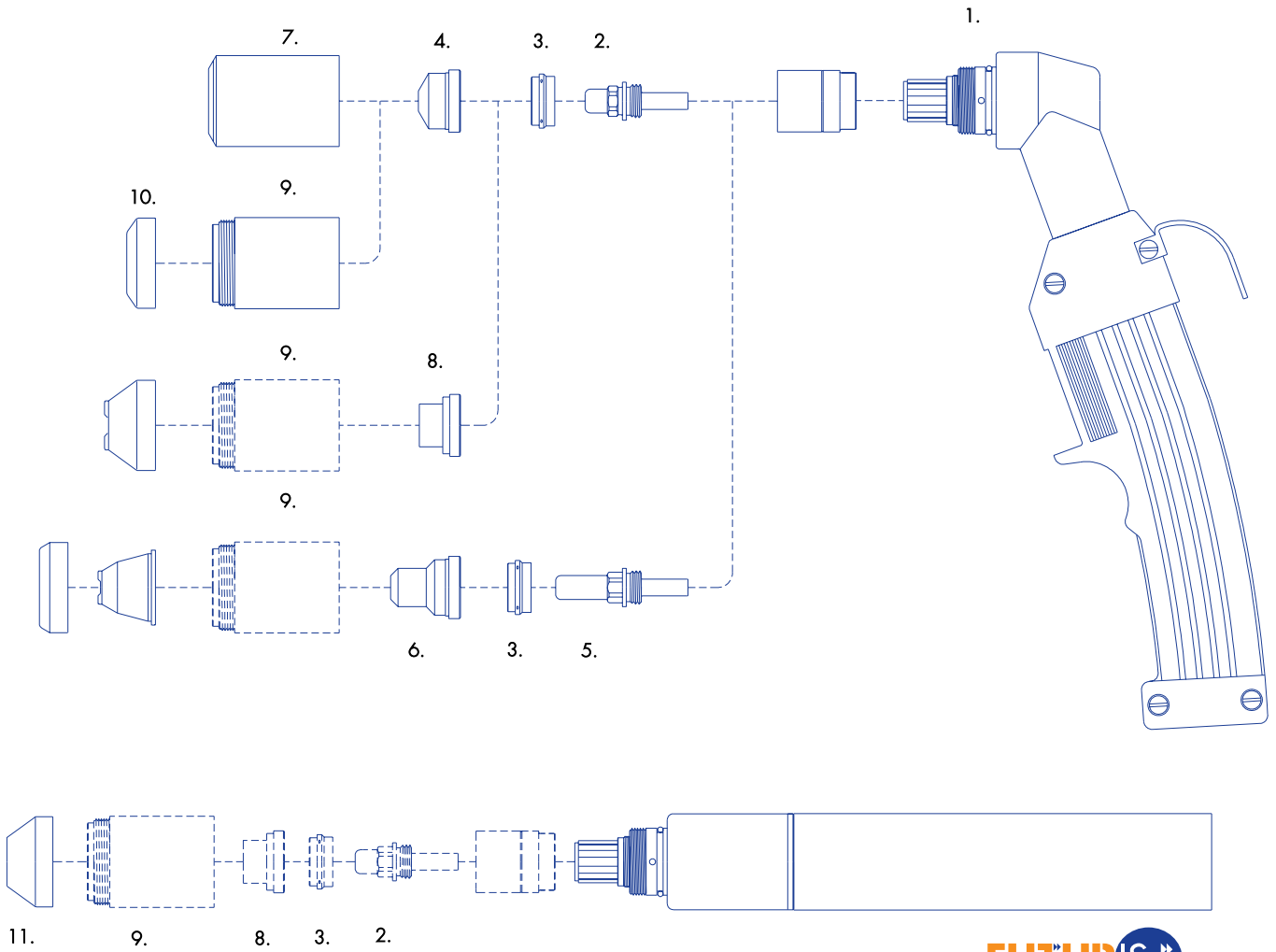

**FUTURIS**®

Key	Description	Code
1	Torch Head - Hand c/w handle & switch	FUTPHY-020189
2	Electrode - AKA 120433	FUTPHY-020191
3	Swirl Ring	FUTPHY-020194
4	Cutting Tip 40A 1.0mm	FUTPHY-020203
	Cutting Tip 80A 1.3mm	FUTPHY-020345
	Cutting Tip 100A 1.5mm	FUTPHY-020195
5	Long Electrode	FUTPHY-020564
6	Long Cutting Tip 1.4mm	FUTPHY-020563
7	Nozzle Retaining Cap	FUTPHY-020184
8	Contact Tip 80A 1.3mm	FUTPHY-020397
	Contact Tip 100A 1.5mm	FUTPHY-020337
9	Contact Nozzle Retaining Cap	FUTPHY-020336
10	Deflector	FUTPHY-020333
11	Shield Cup - Machine	FUTPHY-020334

### Powermax 800

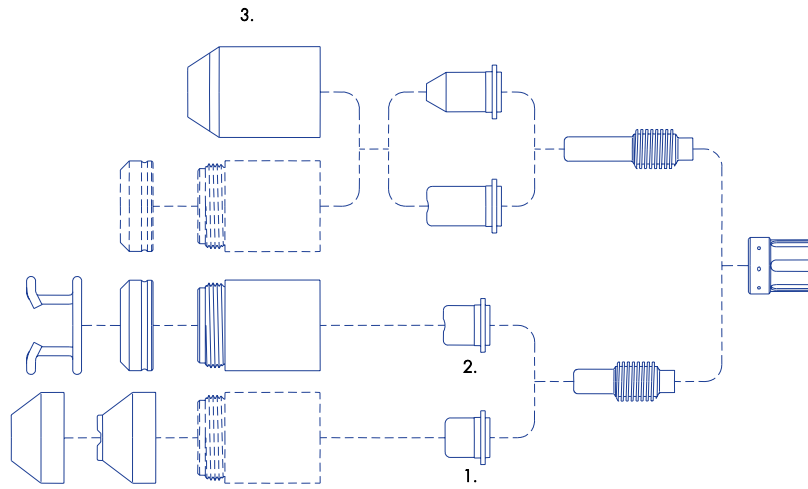

Key	Description	Code
1	Cutting Tip 50A PAC121T/M	FUTPHY-120282
2	Cutting Tip 50A PAC121T	FUTPHY-020395
3	Nozzle Retaining Cap	FUTPHY-020930

### Powermax 1000 / 1100 / 1250 / 1650

#### 40-80A

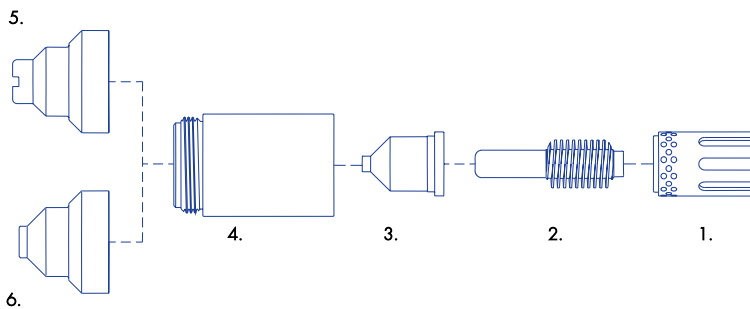

Key	Description	Code
1	Swirl Ring	FUTPHY-120925
2	Electrode 40-80A	FUTPHY-120926
3	Cutting Tip 40 A	FUTPHY-120932
	Cutting Tip 60 A	FUTPHY-120931
	Cutting Tip 80 A	FUTPHY-120927
4	Retaining Cap	FUTPHY-120928
5	Shield - Hand	FUTPHY-120929
6	Shield - Machine	FUTPHY-120930
7	Swirl Ring	FUTPHY-220051
8	Electrode 100A	FUTPHY-220037
9	Cutting Tip 100 A	FUTPHY-220011
10	Retaining Cap	FUTPHY-220048
11	Shield - Hand	FUTPHY-220065
12	Shield - Machine	FUTPHY-220047

#### 100A

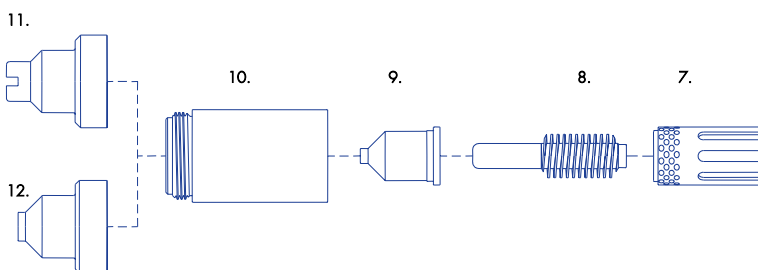

# ▶▶ Plasma Cutting

## Thermal Dynamics® Style Plasma Spares

### PCH 25

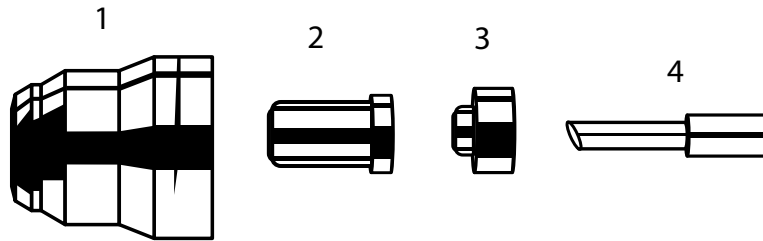

	Code
1 Shield Cup	FUTPTD-9-6003
2 Cutting Tip - Air	FUTPTD-9-4476
3 Gas Distributor	FUTPTD-9-6007
4 Electrode	FUTPTD-9-6006

### PCH/M 35

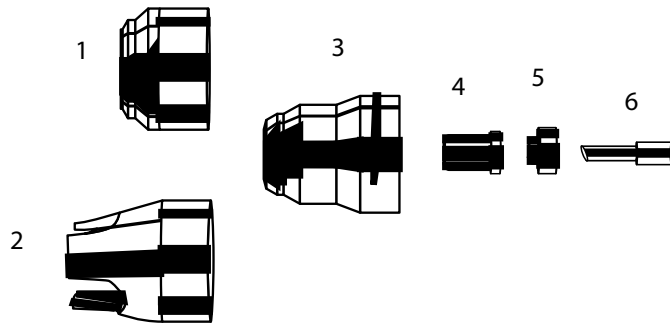

Key	Description	Code
1	Shield Cup - Long Life	FUTPTD-9-6503
2	Shield Cup - Crown	FUTPTD-9-6004
3	Shield Cup	FUTPTD-9-6003
4	Cutting Tip - Stand Off (Long Life)	FUTPTD-9-6500
	Cutting Tip - Drag (Long Life)	FUTPTD-9-6501
	Cutting Tip 35A - Air	FUTPTD-9-6000
	Cutting Tip 35A - Air - Drag	FUTPTD-9-6001
	Tip - Gouging	FUTPTD-9-6002
5	Gas Distributor	FUTPTD-9-6007
6	Electrode - Long Life	FUTPTD-9-6506

### PCH/M 51

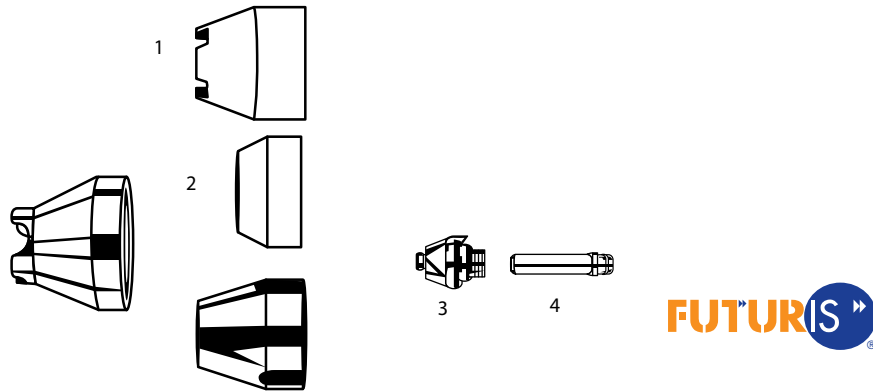

Key	Description	Code
1	Shield Cup - Ceramic - Crown	FUTPTD-8-5526
2	Shield Cup - Ceramic	FUTPTD-9-5630
3	Cutting Tip 10-60A	FUTPTD-9-5631
4	Electrode	FUTPTD-9-5633

### PCH/M 52

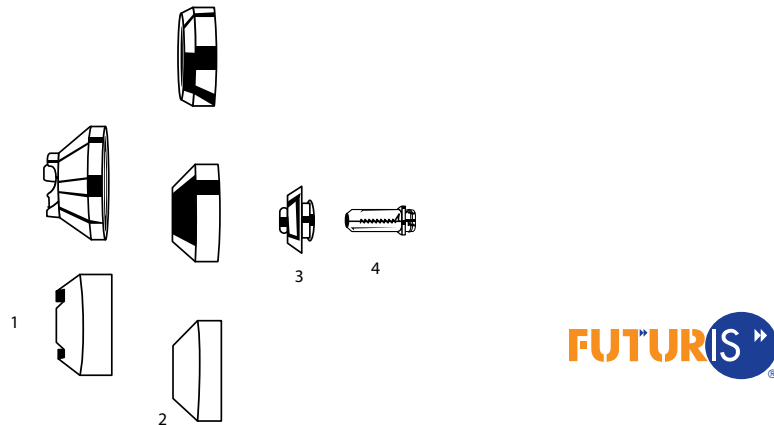

Key	Description	Code
1	Shield Cup - Ceramic - Crown	FUTPTD-9-5694
2	Shield Cup - Ceramic	FUTPTD-9-5617
3	Cutting Tip - 45-55A	FUTPTD-9-5618
	Cutting Tip 60-70A	FUTPTD-9-5707
	Cutting Tip 105A	FUTPTD-9-5708
4	Electrode - Air - Plated	FUTPTD-9-5619

# ▶▶ Plasma Cutting

## Thermal Dynamics® Style Plasma Spares

### PCH/M 70

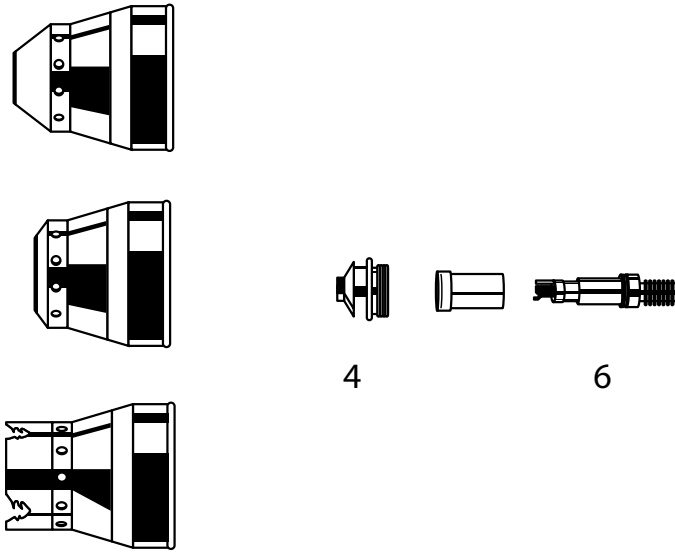

**FUTURIS** »

Key	Description	Code
1	Tip 70A - Air/O <sub>2</sub> /N <sub>2</sub>	FUTPTD-9-6009
2	Electrode - Air/O <sub>2</sub> /N <sub>2</sub>	FUTPTD-9-6019

### PCH/M 75

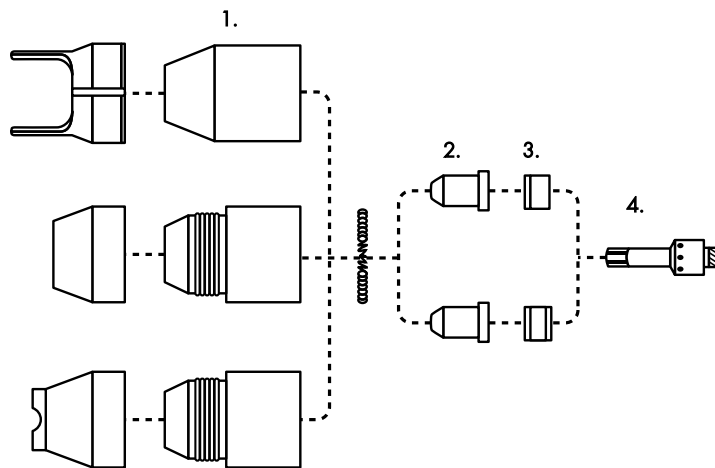

**FUTURIS** »

Key	Description	Code
1	Shield Cup	FUTPTD-8-7500
2	Cutting Tip 35A - Air/ N <sub>2</sub>	FUTPTD-8-7503
	Cutting Tip 55A	FUTPTD-8-7504
3	Gas Distributor	FUTPTD-8-7501
4	Electrode - Air/N <sub>2</sub>	FUTPTD-8-7502

### PCH/M 150

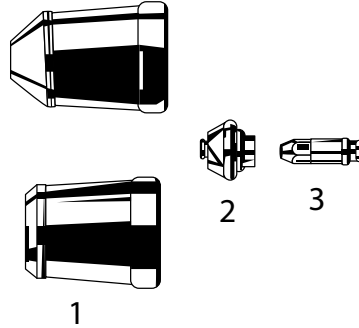

Key	Description	Code
1	Shield Cup	FUTPTD-9-5758
2	Cutting Tip - Air - 0.055	FUTPTD-9-5747
	Cutting Tip - Air - 0.043	FUTPTD-9-5748
3	Electrode - Air	FUTPTD-9-5749

# ▶▶ Plasma Cutting Trafimet® Style Plasma Spares

## S25 / S25K / S45

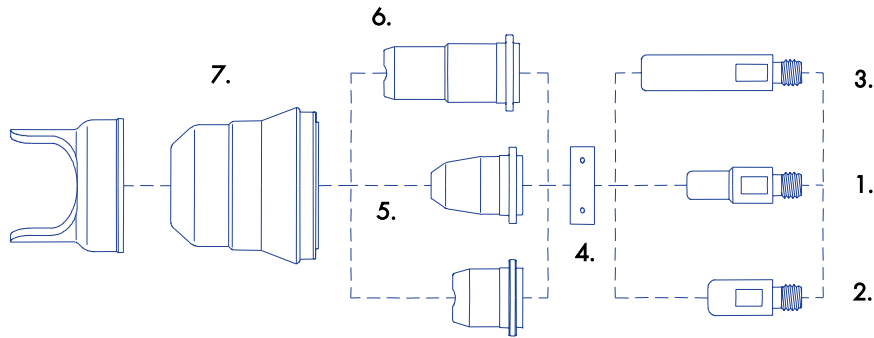

Key	Description	Code
1	Electrode	FUTPTR-PR110
2	Electrode S45	FUTPTR-PR105
3	Long Electrode	FUTPTR-PR106
4	Swirl Ring	FUTPTR-PE106
5	Cutting Tip 0.65mm	FUTPTR-PD116-06
	Cutting Tip 0.8mm	FUTPTR-PD116-08
	Cutting Tip 0.9mm	FUTPTR-PD116-09

Key	Description	Code
6	Cutting Tip Long 0.9mm	FUTPTR-PD103-09
7	Protective Nozzle 6 Holes S25/S45	FUTPTR-PC116
	Protective Nozzle 2 Holes S25K	FUTPTR-PC117
-	Circle Cutting Attachment Kit	FUTPTR-CV25

## A81 / P81

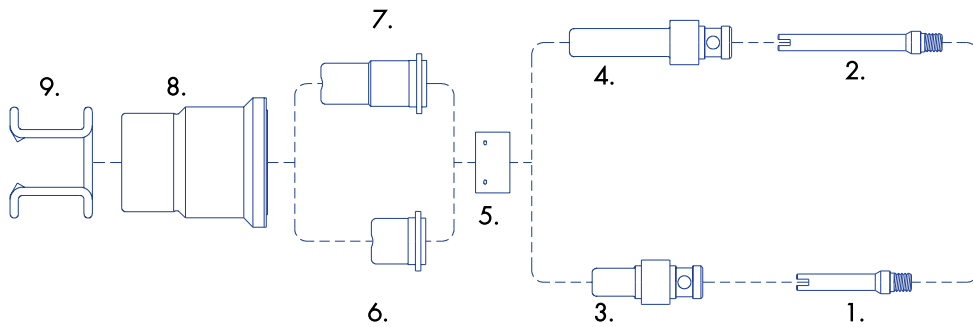

Key	Description	Code
1	Diffuser	FUTPTR-FH560
2	Diffuser - Long	FUTPTR-FH561
3	Electrode - Long Life	FUTPTR-PR109
4	Electrode - Long - Long Life	FUTPTR-PR115
5	Swirl Ring	FUTPTR-PE107
6	Cutting Tip 1.2mm	FUTPTR-PD105-12
7	Cutting Tip Long - 1.2mm	FUTPTR-PD106
8	Protective Nozzle	FUTPTR-PC115
9	Stand Off Spring	FUTPTR-CV28



### A101 / P101

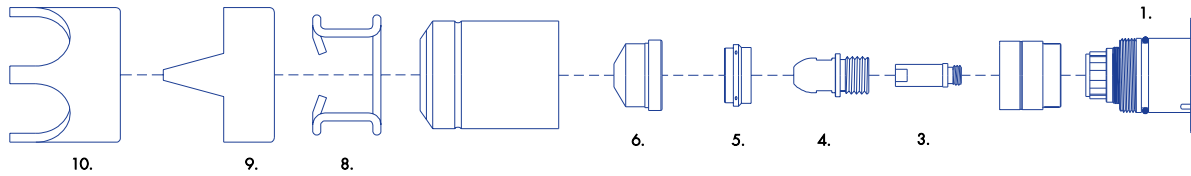

Key	Description	Code
1	O-Ring Torch Head	FUTPTR-EA131
3	Diffuser	FUTPTR-FH562
4	Electrode A101/A141	FUTPTR-PR101
5	Swirl Ring	FUTPTR-PE101
	Swirl Ring - Long Electrodes/Tips	FUTPTR-PE103
6	Cutting Tip 1.1mm 40-60 A	FUTPTR-PD101-11
	Cutting Tip 1.4mm 50-80 A	FUTPTR-PD101-14
	Cutting Tip 1.7mm 70-120 A	FUTPTR-PD101-17
	Cutting Tip 1.9mm 110-140 A	FUTPTR-PD101-19
8	Stand Off Spring	FUTPTR-CV11
9	Crown Shield - 2 Pins	FUTPTR-CV12
10	Crown Shield - 4 Pins	FUTPTR-CV14

# ▶▶ Plasma Cutting Trafimet® Style Plasma Spares

A141 / P141

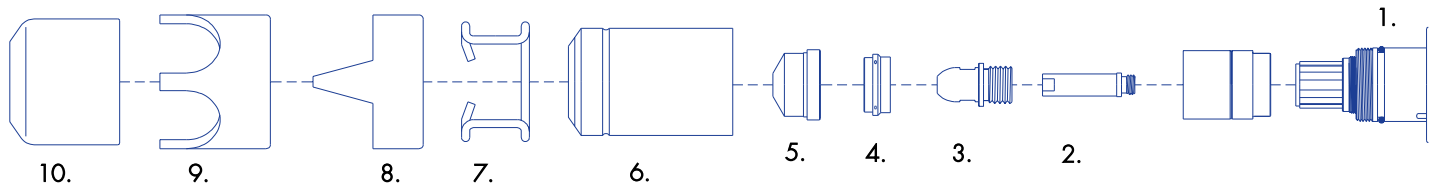

Key	Description	Code
1	O-Ring Torch Head	FUTPTR-EA131
2	Diffuser	FUTPTR-FH563
3	Electrode A101/A141	FUTPTR-PR101
4	Swirl Ring	FUTPTR-PE101
	Swirl Ring - Long Electrodes/Tips	FUTPTR-PE103
5	Cutting Tip 1.1mm 40-60 A	FUTPTR-PD101-11
	Cutting Tip 1.4mm 50-80 A	FUTPTR-PD101-14
	Cutting Tip 1.7mm 70-120 A	FUTPTR-PD101-17
	Cutting Tip 1.9mm 110-140 A	FUTPTR-PD101-19
6	Protective Nozzle	FUTPTR-PC101
7	Stand Off Spring	FUTPTR-CV11
8	Crown Shield - 2 Pins	FUTPTR-CV12
9	Crown Shield - 4 Pins	FUTPTR-CV14
10	Gouging Shield	FUTPTR-CV13

### A151 / P151

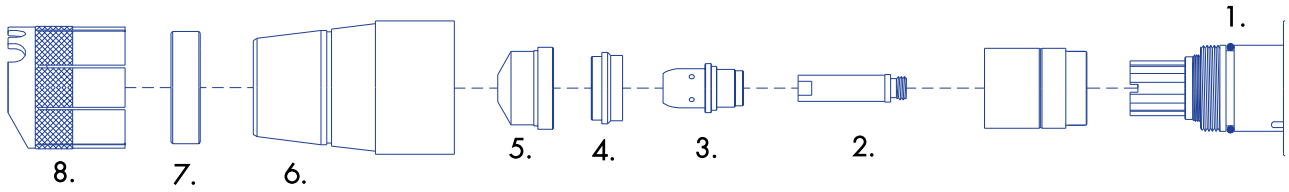

Key	Description	Code
1	O-Ring Torch Head	FUTPTR-EA131
2	Diffuser	FUTPTR-FH563
3	Electrode	FUTPTR-PR111
4	Swirl Ring	FUTPTR-PE103
5	Cutting Tip 1.4mm	FUTPTR-PD109-14
	Cutting Tip 1.6mm	FUTPTR-PD109-16
	Cutting Tip 1.8mm	FUTPTR-PD109-18
6	Protective Nozzle	FUTPTR-PC120
7	Nozzle Shield	FUTPTR-BW139
8	Contact Cutting Attachment	FUTPTR-CV1105

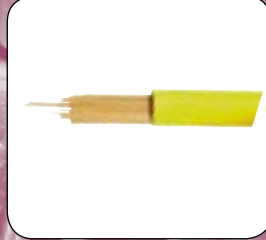

MIG Wire	102
MIG Wire - Disposable Gas Cylinders	103
Filler Wires & Metals	104
Filler Wires & Metals - Fluxes	105
Fluxes	106-107

# Welding Consumables ▶▶

# ▶▶ Welding Consumables

## MIG Wire

### Mig Wire - Mild Steel A18

- Lloyds registered mild steel welding wire in 0.7kg, 5kg & 15kg spools
- GB/T 8110 ER50-6 - AWS A5.18 ER70S-6JIS - ZZ3316 YGM12 - DIN8575-1 SG2

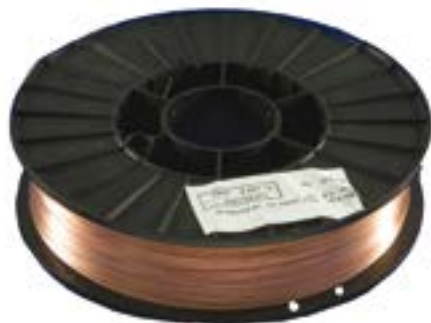

Code	Description	Kg
FUTMSW06X07KG	Mild Steel Wire A18 0.6mm	0.7
FUTMSW06X5KG	Mild Steel Wire A18 0.6mm	5
FUTMSW06X015KG	Mild Steel Wire A18 0.6mm	15
FUTMSW08X07KG	Mild Steel Wire A18 0.8mm	0.7
FUTMSW08X5KG	Mild Steel Wire A18 0.8mm	5
FUTMSW08X15KG	Mild Steel Wire A18 0.8mm	15
FUTMSW10X5KG	Mild Steel Wire A18 1.0mm	5
FUTMSW10X15KG	Mild Steel Wire A18 1.0mm	15
FUTMSW12X5KG	Mild Steel Wire A18 1.2mm	5
FUTMSW12X15KG	Mild Steel Wire A18 1.2mm	15

### Mig Wire - Aluminium

- 5356 & 4043A Grade Aluminium
- Available in 0.8mm, 1.0mm & 1.2mm diameter and 0.5kg, 2kg & 7kg weights

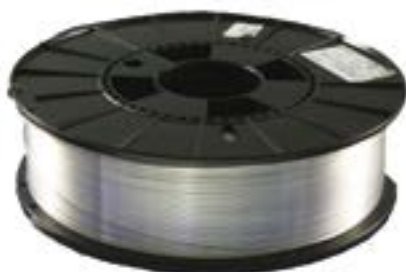

Code	Description	Kg
260010	Aluminium 5% Wire 0.8mm Magnesium - 5356	0.5
260090	Aluminium 5% Wire 0.8mm Magnesium - 5356	2
260095	Aluminium 5% Wire 0.8mm Magnesium - 5356	7
260020	Aluminium 5% Wire 1.0mm Magnesium - 5356	0.5
260100	Aluminium 5% Wire 1.0mm Magnesium - 5356	2
260105	Aluminium 5% Wire 1.0mm Magnesium - 5356	7
260030	Aluminium 5% Wire 1.2mm Magnesium - 5356	0.5
260110	Aluminium 5% Wire 1.2mm Magnesium - 5356	2
260115	Aluminium 5% Wire 1.2mm Magnesium - 5356	7
260050	Aluminium 5% Wire 0.8 mm Silicon - 4043	0.5
260130	Aluminium 5% Wire 0.8 mm Silicon - 4043	2
260135	Aluminium 5% Wire 0.8 mm Silicon - 4043	7
260060	Aluminium 5% Wire 1.0 mm Silicon - 4043	0.5
260140	Aluminium 5% Wire 1.0 mm Silicon - 4043	2
260145	Aluminium 5% Wire 1.0 mm Silicon - 4043	7

### Mig Wire - Stainless Steel

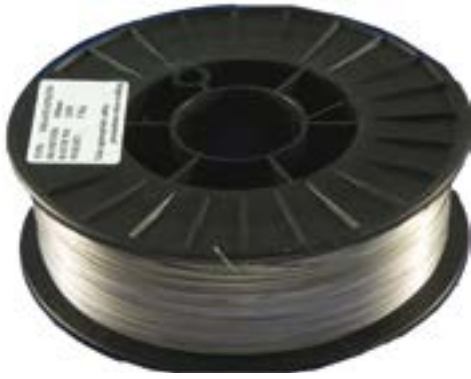

- Stainless steel wire with low carbon content, corrosion resistant
- 0.8mm diameter wire 5kg weight

Code	Description	Kg
260230	Stainless Steel Wire - 0.8mm Moly 316LSI	5

### Mig Wire - Flux Cored

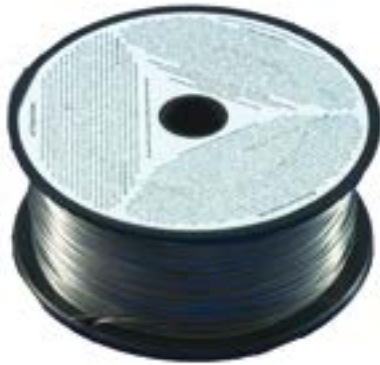

- Flux coated MIG wire for use with our MIG welding sets
- Choose from 0.8mm or 0.9mm with either 0.45kg (1lb) or 4.5kg

Code	Description	Kg
170040	Gaseless MIG Wire 0.8mm	0.45
170045	Gaseless MIG Wire 0.8mm	4.5
170041	Gaseless MIG Wire 0.9mm	0.45
170046	Gaseless MIG Wire 0.9mm	4.5

### Disposable Gas Cylinders

- Handy disposable welding gas cylinder from the quality Futuris range



**Argon 60L**  
070508



**Argon/CO<sub>2</sub> 60L**  
070509



**CO<sub>2</sub> 290g**  
070512



Code	Description	Pack
070508	Disposable Gas Cylinder - Argon 60Litres	12
070509	Disposable Gas Cylinder - Argon/CO2 Mix 10 Litres	12
070512	Disposable Gas Cylinder - CO2 390g	12

# ▶▶ Welding Consumables

## Filler Wires & Metals

### Filler Wires - Aluminium (Silicon Rod)



- Aluminium alloy with 5% Silicon delivering excellent flow characteristics and penetration
- Suitable for welding cast and wrought alloys
- Al4043
- AlSi5

Code	Description	Ctn
040461	1.6mm Silicon Rod	2.5kg
040642	2.4mm Silicon Rod	2.5kg
040643	3.2mm Silicon Rod	2.5kg

### Filler Wires - Aluminium (Magnesium Rod)



- A general purpose 5% magnesium wire with high strength and excellent corrosion resistance
- Suitable for magnesium bearing alloys and certain heat
- Al5356
- AlMg5

Code	Description	Ctn
040644	1.6mm Magnesium Rod	2.5kg
040645	2.4mm Magnesium Rod	2.5kg
040646	3.2mm Magnesium Rod	2.5kg

### Filler Wires - Silicon Bronze

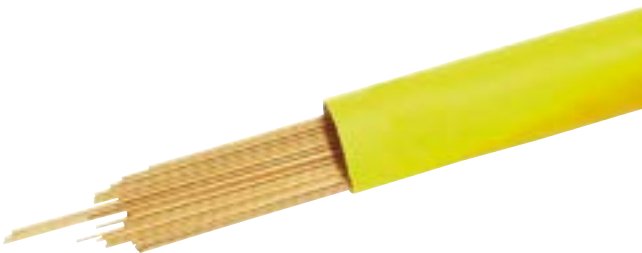

- A general purpose low temperature brazing rod for use on dissimilar steels, cast iron, copper & its alloys, mild steel and galvanised steel
- Suitable where increased fluidity is required using brazing flux
- CZ6 - BS1845

Code	Description	Ctn
040651	1.6mm Silicon Bronze - BS1845	2.5kg
040652	2.4mm Silicon Bronze - BS1845	2.5kg
040653	3.2mm Silicon Bronze - BS1845	2.5kg

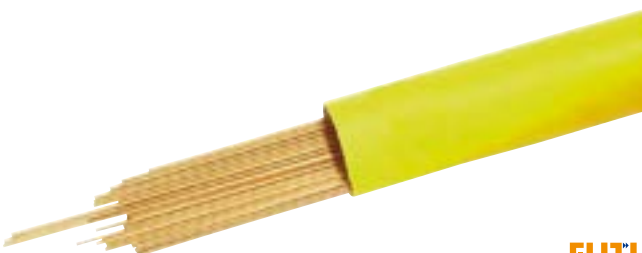

- A low carbon mild steel filler wire suitable for all types of mild steel and wrought iron welding
- CZ6 - BS1453

Code	Description	Ctn
040671	1.6mm CCMS A1 - BS1453	5kg
040672	2.4mm CCMS A1 - BS1453	5kg
040673	3.2mm CCMS A1 - BS1453	5kg

### Filler Wires - Stainless Steel



FUTURIS

#### Stainless Steel 316L

- For welding molybdenum bearing stainless steels. Acid resistant. Widely used in nuclear and chemical industries

#### Stainless Steel 308

- Suitable for welding 304 austenitic stainless steel with excellent wear and corrosion resistance properties

Code	Description	Ctn
040681	1.6mm Stainless steel 316L S92	2.5kg
040682	2.4mm Stainless steel 316L S92	2.5kg
040695	1.6mm Stainless steel 308 S92	2.5kg
040696	2.4mm Stainless steel 308 S92	2.5kg

### Filler Wires - Supersteel



FUTURIS

- Copper coated triple deoxidised mild steel for TIG welding, pipework etc

- BS2901 A15

Code	Description	Ctn
040677	1.6mm Supersteel - BS2901	5kg
040678	2.4mm Supersteel - BS2901	5kg
040679	3.2mm Supersteel - BS2901	5kg

### Filler Wires - Flux Coated

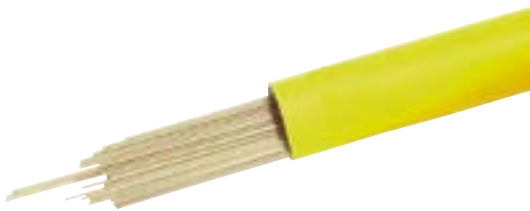

FUTURIS

- As with Silicon Bronze, the fully coated wire provides the additional benefit of faster continuous brazing

- BS1845 CZ6

Code	Description	Ctn
040667	1.6mm Flux Coated CZ6 - BS1845	2.5kg
040668	2.4mm Flux Coated CZ6 - BS1845	2.5kg



# ▶▶ Welding Consumables Fluxes

## Silver Flo - Johnson Matthey AG14



- Silver-Flo™ is a cadmium free silver brazing filler metal. It combined a low brazing temperature with a short melting range
- Free flowing producing neat joints with small fillets.
- BS1845

Code	Description	Pack
040900	Silver-Flo 55 Flux AG14 600 X 1.5mm	5

## Silver Flo - Johnson Matthey Flux Coated



- Silver-Flo™ is a cadmium free silver brazing filler metal. It combined a low brazing temperature with a short melting range
- Free flowing producing neat joints with small fillets.
- Can be used to join all common engineering materials (excluding aluminium) such as copper, copper alloys, steels, tungsten carbide and PCD segments
- BS1845

Code	Description	Pack
040905	Silver-Flo 55 Flux Coated 500 X 1.5mm	5

## Easy Flo Flux - Johnson Matthey



- Sold worldwide and is recognised as one of the best flux powders available
- This alloy is particularly recommended where a minimum brazing temperature is desirable to preserve the properties of the parent metal
- Powder working ranges 550 to 800°C
- Paste working ranges 575 to 825°C

Code	Description	Pack
JMEASYFLUX-500	Easy Flo Flux Powder 500g	1
040970	Easy Flo Flux Powder 250g	1
040975	Easy Flo Flux Paste 500g	1

## Futuris Fluxes

- A value for money range of fluxes for all common applications
- High temperature quality general purpose welding & brazing flux, essential to produce clean homogeneous joints by removing impurities and oxides



Code	Description	Pack	Usage	Features
FUT040611	Aluminium Flux 225g	1	with aluminium filler metals & alloys	FB201 Flux - working range 600-850°C
FUT040612	Brazing Flux 225g	1	with copper based brazing filler metals	S301 Flux - working range of 850-1100°C
FUT040613	Brazing Flux 500g	1	with copper based brazing filler metals	S301 Flux - working range of 850-1100°C
FUT040614	Silver Solder Flux 225g	1	with silver brazing metals on common engineering materials	S102 Flux - working range of 600-850°C

## Type B Solar Flux



A unique back-up flux for all welding processes for stainless and alloy steels. Formulated to shield the back of a weld-joint from oxygen contamination, dissipate heat and oxides, clean the surface of the metal and prevent re-oxidation.

- Ideal for pipe and tube welding applications and maintenance welding
- Inert, non-flammable and non-explosive

Code	Description	Pack
SOLAR-B	Solar Flux Type B - 1lb (450g)	1



# 3M Speedglas

Introduction to Auto-Darkening Filters (ADFs)	110-111
9100 Series Introduction	112-113
9100 Welding Helmets	114
9100FX Flip-Up Welding Helmets	115
9100 Hard Hat Welding Helmets	116
9100 Series Spares & Accessories	117
100 Series Introduction	118
100 Welding Helmets	119
100 Series Spares & Accessories	120
SL Welding Helmet Introduction	121
SL Spares & Accessories	122
General guide to respiratory protection	124-125
9100 Welding Adflo Powered Air Respirator Systems	126-127
ClearVisor Faceshields for Adflo Powered Air Respirator	128
Adflo Powered Air Turbo Unit	129
9100 and 9100FX Air Helmets - Spares & Accessories	130-131
Compatibility of 3M Air Delivery Units Headtops	132
9100 Fresh-air C™ Compressed Air Regulator Systems	133-134
ClearVisor Faceshields for Fresh-air C™ Compressed Air Regulator	135
Fresh-air C™ Compressed Air Regulator	136
9100 MP Welding & Safety	137-138
9100 and 9100FX Air Helmets - Spares & Accessories	139-140
Parts List for Respiratory Protection	141-143
9002D Welding Helmet	146-147
9000 FlexView Welding Helmet	148
9000 Series Spares & Accessories	149
9000 Series Air Helmets for Respiratory Protection	150



# ▶▶ 3M Speedglas

## Introduction to Auto-Darkening Filters (ADFs)

The table below is a general guide to the various models of 3M™ Speedglas™ Auto-Darkening Filters:

	Speedglas 100V	Speedglas 9100V	Speedglas 9100X	Speedglas 9100XX	Speedglas SL	Speedglas 9002D	Speedglas 9002V	Speedglas 9002X
<b>Dark state</b>	Shade 8 -12 (variable)	Shade 5, 8, 9-13 (variable)	Shade 5, 8, 9-13 (variable)	Shade 5, 8, 9-13 (variable)	Shade 8 -12 (variable)	Shade 9/11 (dual)	Shade 9-13 (variable)	Shade 9-13 (variable)
<b>MMAW (Electrode)</b>	Optimised	Optimised	Optimised	Optimised	Optimised	Optimised	Optimised	Optimised
<b>MIG/MAG</b>	Optimised	Optimised	Optimised	Optimised	Optimised	Optimised	Optimised	Optimised
<b>TIG (&gt;20A)</b>	Suitable	Optimised	Optimised	Optimised	Optimised	Suitable	Optimised	Optimised
<b>TIG (1A-20A)</b>	Not recommended	Optimised	Optimised	Optimised	Suitable	Not recommended	Suitable	Suitable
<b>Plasma (welding and cutting)</b>	Not recommended	Optimised	Optimised	Optimised	Suitable	Not recommended	Suitable	Suitable
<b>Risk of hidden arc</b>	Not recommended	Optimised	Optimised	Optimised	Suitable	Not recommended	Suitable	Suitable
<b>Tack welding</b>	Suitable	Optimised	Optimised	Optimised	Suitable	Suitable	Suitable	Suitable
<b>Grinding</b>	Suitable	Optimised	Optimised	Optimised	Not recommended	Suitable	Suitable	Suitable

For assistance with choosing the right ADF, please call the 3M Safety Helpline on 0870 60 800 60 (UK) or 1 800 320 500 (Ireland)

### Technical data Speedglas welding helmet with ADF

	3M™ Speedglas™ 100 Helmet Black & Graphics Editions	3M™ Speedglas™ 9100 Series Helmet			3M™ Speedglas™ SL Helmet	3M™ Speedglas™ 9000 Series Helmets (Phase out)		
	100V ADF (variable)	9100V ADF (variable)	9100X ADF (variable)	9100XX ADF (variable)	SL ADF (variable)	9002D ADF (dual)	9002V ADF (variable)	9002X ADF (variable)
Welding Filter Options	100V ADF (variable)	9100V ADF (variable)	9100X ADF (variable)	9100XX ADF (variable)	SL ADF (variable)	9002D ADF (dual)	9002V ADF (variable)	9002X ADF (variable)
Viewing area	44 x 93mm	45 x 93mm	54 x 107mm	73 x 107mm	42 x 93mm	42 x 93mm	42 x 93mm	55 x 107mm
Weight (complete helmet incl. ADF)	510g	510*g	520*g	545*g	360g	710g	750g	770g
Dark state	Shade 8-12	Shade 5, 8, 9-13			Shade 8-12	Shade 9/11	Shade 9-13	
Light state	Shade 3	Shade 3			Shade 3	Shade 3		
UV / IR Protection	Shade 12 (permanent)	Shade 13 (permanent)			Shade 12 (permanent)	Shade 13 (permanent)		
Auto ON	No	No			Yes	No		
Switching time, light - dark	0,1 ms (+23°C)	0,1 ms (+23°C)			0,1 ms (+23°C)	0,4 ms (+23°C)	0,1 ms (+23°C)	
Switching time, dark - light (Delay)	100-250 ms	40-1300 ms			60-250 ms	100-200 ms	60-500 ms	
SideWindows option	No	Yes			No	Yes		
Exhaust vents	No	Yes			No	Yes		
Hard hat option	Yes	No			No	Yes		
Solar cell	No	Yes	Yes	No	No	No	No	Yes
Number of sensors (arc detection)	2	3			2	2		
Battery lifetime	1,500 hours	2,800 hours	2,500 hours	2,000 hours	1,500 hours	1,500 hours	1,500 hours	3,000 hours

\* Weight of 9100 Helmet without SideWindows.

**3M**

**Speedglas™**

The innovator of the 3M™ Speedglas™ Auto-Darkening Welding Filter (ADF) completed his thesis in the shipyards of Sweden studying ways to protect welders' eyes and skin from harmful UV radiation.

The studies were conducted more than 30 years ago and resulted in the first prototype of an auto-darkening welding filter, a combination of liquid crystal elements, polarizers and electronics.

The key point to remember with 3M™ Speedglas™ auto-darkening filters is consistency. As well as enabling constant and comfortable vision, they provide protection from ultraviolet and infrared (UV/IR) radiation and consistently auto-switch from clear to dark and back again, in just the way the welder wants.



### Before

With the helmet in the safe down position, the welder has a clear view through the welding filter. Both hands are free and the electrode can be precisely positioned.



### During

Within 0.1 milliseconds of the arc strike, the filter has switched to the dark state.



### After

The filter automatically returns to the clear state after welding is complete, allowing for immediate and safe inspection of the weld pool, as well as preparation for the next weld.

Being one of the first of its type on the market, the 3M™ Speedglas™ Auto-Darkening Filter brought a new standard to eye protection and comfort for welders. Today there is a great family of 3M™ Speedglas™ welding helmets, each model with its specific series of welding filters.

There are a few parameters that affects the performance of an auto-darkening welding filter like the type of welding machine, working environments etc.

### Before you select a model, ask yourself:

- How will I use my ADF?
- Do I occasionally change welding process/shade number?
- This is a long term investment. A variable welding filter offers more flexible features for new working conditions.

# ▶▶ 3M Speedglas 9100 Series Introduction



Optimise your welding comfort, coverage and control. The 3M™ Speedglas™ 9100 Series welding helmets feature a head suspension system that profiles your unique head shape for a secure, stable fit.

## High comfort head suspension

Two crown straps gently saddle the top of the head for increased helmet stability and better weight distribution. Both straps are adjustable to fit virtually all head shapes and sizes.

The back portion of the headband is self-adjusting and swivels to fit different head shapes. When wearing a cap backwards you simply turn the back portion upside-down.

The headband can also be manually tightened to your personal preference. The smooth ratchet mechanism allows for precise tightening control.

A snap adjustment allows you to set the helmet at 9 different angles.

The front of the headband self-adjusts to match your forehead. Pressure is evenly distributed to sets of twin pads to fit the exact shape of your head.

4 settings let you determine the distance between your face and the helmet. This allows you to keep it as close as possible to your face for a greater view and reduces the load on your neck muscles.

Small, Medium or Large?  
You can adjust the width of the head suspension to your own head size – from 50cm to 64cm.

Lower centre of gravity! This makes the helmet more stable in both the up and down positions, as well as reducing the leveraged strain on your neck. Large rubber overmoulded knobs make it easy to adjust the up-and-down pivot action, even when wearing gloves.

### More comfort when raised

Lifted into the raised position, the helmets "high point" is lower than many other helmets. The smooth up-and-down pivot action can be "locked" in the up position – a light pull lowers the helmet back down again.

### Excellent optics, bigger view

The 9100 Series welding filters continue our tradition of outstanding optical quality, including uniform shading and minimal distortion across the entire filter viewing area.

### Wider field of view

Introducing the 9100FX welding helmet, a flip-up combination of an ADF welding helmet and a protective visor (see p.7 and 9 for more details).

## Comfortable protection for safer welders

The 3M™ Speedglas™ 9100 Series welding helmets are available either with the ADF in a fixed position or with the ADF in a flip-up visor which can be lifted to leave a clear visor (9100FX).

The 9100FX features a flip-up combination of an auto-darkening welding helmet and a protective visor. Not only is the viewing area of the helmet larger than on previous models (17x10cm), the geometry of the helmet has also been redesigned to increase peripheral vision.

### Features and Benefits:

- 30% larger viewing area than any other Speedglas welding filter (9100XX)
- Adjustable sensitivity of arc detection
- 7 variable dark shades (5, 8, 9-13) including shades for gas welding, micro-plasma and low-amp TIG
- Exclusive shade 5 SideWindows option
- The big 17x10cm clear protective visor is curved, increasing your peripheral vision
- Increased coverage for ear and neck
- Exhaled air is channelled out via side exhaust vent



**3M™ Speedglas™ 9100 Welding Helmet**

Classification 1/1/1/2  
 Conforms to EN 175 level B and EN 379  
 Light state shade 3

**Codes:**

- HOR501805 9100 Helmet & 9100V Filter
- HOR501815 9100 Helmet & 9100X Filter
- HOR501825 9100 Helmet & 9100XX Filter



**3M™ Speedglas™ 9100FX Welding Helmet**

Classification 1/1/1/2  
 Conforms to EN 175 level B and EN 379  
 Light state shade 3

**Codes:**

- HOR541805 9100FX Helmet & 9100V Filter
- HOR541815 9100FX Helmet & 9100X Filter
- HOR541825 9100FX Helmet & 9100XX Filter

### All Helmets fit well with 3M™ Respiratory Protection

3M™ 4000 Series Respirator



3M™ 7500 Series Half Mask



3M™ 9900 Series Particle Respirator



**3M™ Speedglas™ 9100 Filter Options:**

- HOR500025 3M™ Speedglas™ 9100XX Filter
- HOR500015 3M™ Speedglas™ 9100X Filter
- HOR500005 3M™ Speedglas™ 9100V Filter

**3M™ Speedglas™ 9100 Common Consumables:**

- HOR526000 outer protection plate standard (pack 10)
  - HOR527000 outer protection plate scratch resistant (pack 10)
  - HOR168015 9100 sweatband (pack 3)
- See page 117 for more consumables

# ▶▶ 3M Speedglas 9100 Welding Helmets



With SideWindows Code	Without SideWindows Code
--------------------------	-----------------------------

## 9100 Welding Helmets (Helmet complete with Auto-Darkening Filter)

9100 Helmet with 9100V filter shade 5, 8, 9-13

HOR501805

HOR501105

9100 Helmet with 9100X filter shade 5, 8, 9-13

HOR501815

HOR501115

9100 Helmet with 9100XX filter shade 5, 8, 9-13

HOR501825

HOR501125

## 9100 Helmet without Auto-Darkening Filter\*

HOR501800

HOR501100

\*Combine with choice of Auto-Darkening Filters from:

## 9100 Auto-Darkening Filters (ADFs)

9100V filter shade 5, 8, 9-13 (45x93mm)

HOR500005

9100X filter shade 5, 8, 9-13 (54x107mm)

HOR500015

9100XX filter shade 5, 8, 9-13 (73x107mm)

HOR500025

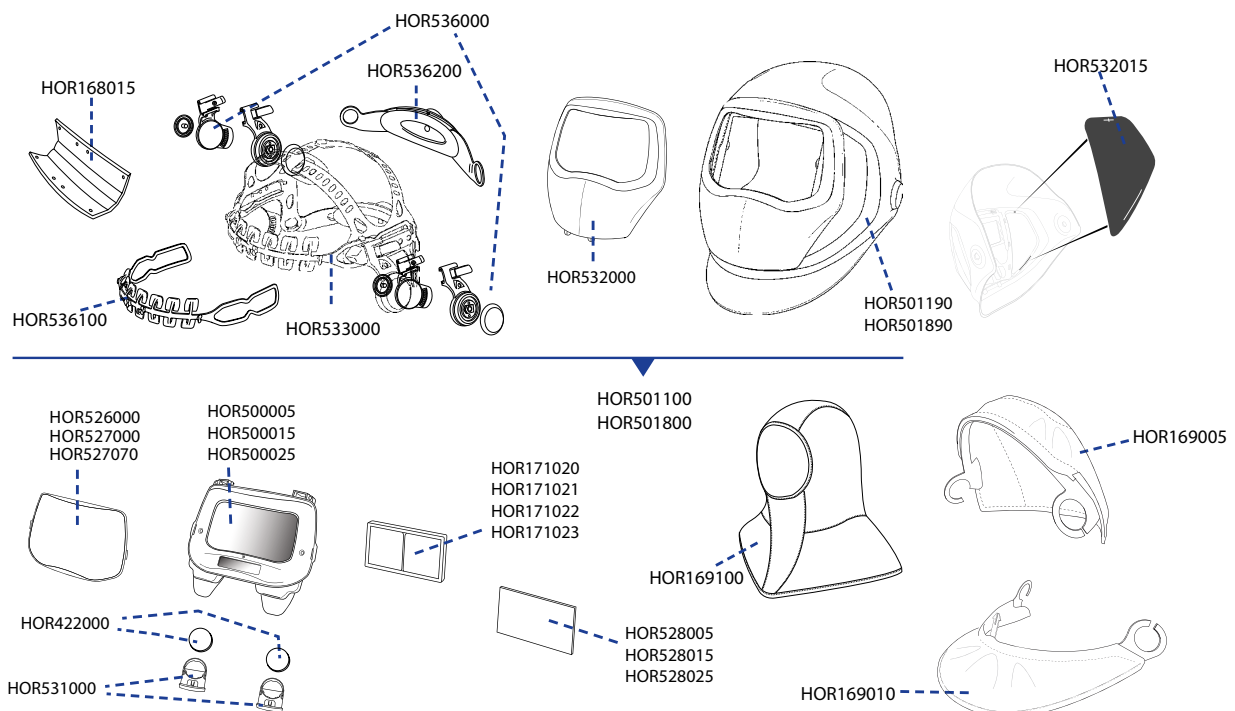





Code

### 9100FX Welding Helmets (Helmet complete with Auto-Darkening Filter)

- 9100FX Helmet with 9100V filter shade 5, 8, 9-13
- 9100FX Helmet with 9100X filter shade 5, 8, 9-13
- 9100FX Helmet with 9100XX filter shade 5, 8, 9-13

- HOR541805
- HOR541815
- HOR541825

### 9100FX Helmet without Auto-Darkening Filter\*

HOR541800

\*Combine with choice of Auto-Darkening Filters from:

### 9100 Auto-Darkening Filters (ADFs)

- 9100V filter shade 5, 8, 9-13 (45x93mm)
- 9100X filter shade 5, 8, 9-13 (54x107mm)
- 9100XX filter shade 5, 8, 9-13 (73x107mm)

- HOR500005
- HOR500015
- HOR500025

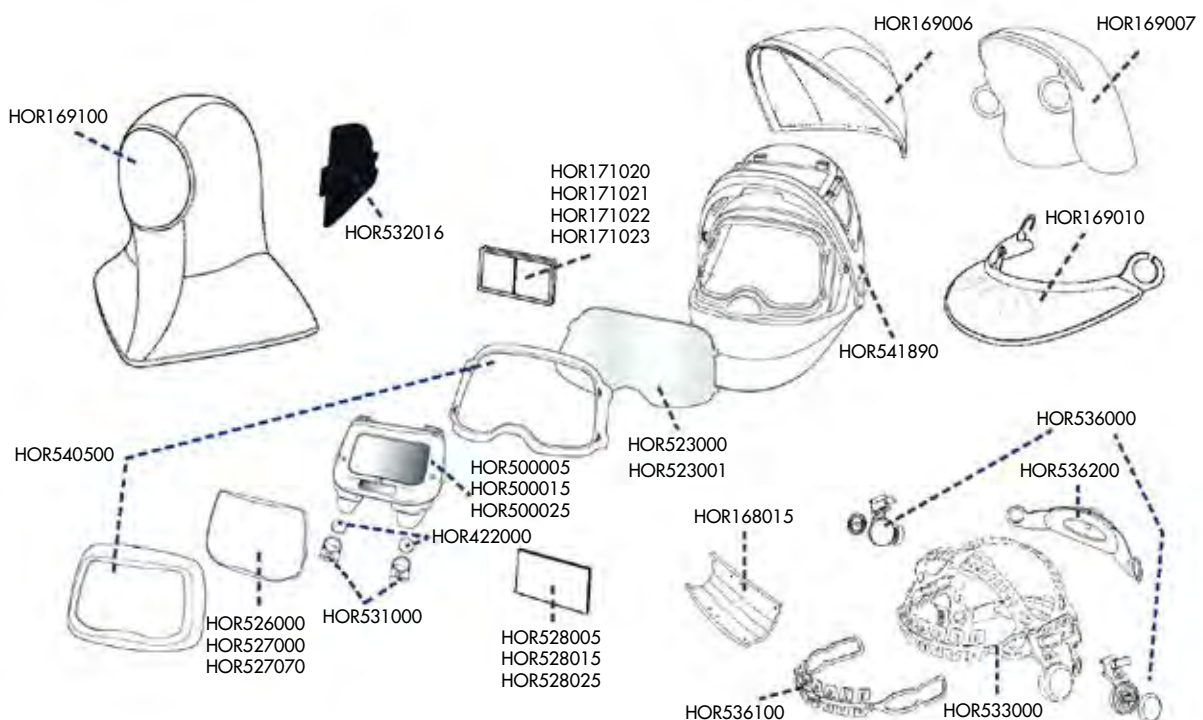

# ▶▶ 3M Speedglas 9100 Hard Hat Welding Helmets



With SideWindows  
Code

## 9100 Welding Helmets (Helmet complete with Auto-Darkening Filter and safety hard hat)

9100 Helmet with 9100V filter shade 5, 8, 9-13 and 3M™ Peltor™ 3001 Safety Hard Hat	HOR583805
9100 Helmet with 9100X filter shade 5, 8, 9-13 and 3M™ Peltor™ 3001 Safety Hard Hat	HOR583815
9100 Helmet with 9100XX filter shade 5, 8, 9-13 and 3M™ Peltor™ 3001 Safety Hard Hat	HOR583825

## 9100 Auto-Darkening Filters (ADFs)

9100V filter shade 5, 8, 9-13 (45x93mm)	HOR500005
9100X filter shade 5, 8, 9-13 (54x107mm)	HOR500015
9100XX filter shade 5, 8, 9-13 (73x107mm)	HOR500025

## Additional spares for 9100 Hard Hat Welding Helmet

3M™ Peltor G3001 safety hard hat with ratchet suspension and plastic sweatband (no ventilation)	3MG3001NUV-VI
---	---------------



**Buff®**  
**Protection**  
THE PREMIUM LINE IN HEADWEAR PROTECTION



**EN Certified  
Fire Resistant  
Buff® headwear  
exclusively available  
at Weldspares**



Fire Resistant



	Code
<b>9100 Outer Protection Plates</b>	
Outer protection plate standard (pack of 10)	HOR526000
Outer protection plate scratch resistant (pack of 10)	HOR527000
Outer protection plate heat resistant (pack of 10)	HOR527070
<b>9100 Inner Protection Plates</b>	
9100V inner protection plate (pack of 5)	HOR528005
9100X inner protection plate (pack of 5)	HOR528015
9100XX inner protection plate (pack of 5)	HOR528025
<b>9100 Sweatband</b>	
9100 Sweatband (pack of 3)	HOR168015
<b>9100 Head, Ear and Throat Protection</b>	
9100 Extended head protector	HOR169005
9100 Extended throat and ear protector	HOR169010
9100 Hood throat / Head protector	HOR169100
<b>9100 Other Items</b>	
9100 Helmet (excl. SideWindows) without headband	HOR501190
9100 SideWindows Helmet without headband	HOR501890
9100 Silver front cover	HOR532000
9100 Headband, complete	HOR533000
9100 Headband pivot mechanism, both sides	HOR536000
9100 Headband front part	HOR536100
9100 Headband back part	HOR536200
9100 Battery holder (pack of 2)	HOR531000
9100 Coverplate SideWindows (pack of 2 pairs)	HOR532015
Battery (pack of 2)	HOR422000
Speedglas tube bag	HOR940419
Speedglas welding caps	HOR954410
<b>9100FX Consumables</b>	
9100FX Helmet without headband	HOR541890
9100FX Visor Plate (pack of 5)	HOR523000
9100FX Visor Plate Anti-Fog (pack of 5)	HOR523001
9100FX Front Cover Unit	HOR540500
9100FX SideWindows Cover Plate, 2 pairs	HOR532016
9100FX Head Cover small	HOR169006
9100FX Head Cover Large	HOR169007
<b>Magnifying Lenses</b>	
Magnifying Lens 1.0	HOR171020
Magnifying Lens 1.5	HOR171021
Magnifying Lens 2.0	HOR171022
Magnifying Lens 2.5	HOR171023

# ▶▶ 3M Speedglas 100 Series Introduction



**\*New features  
on Q1 2013  
models**

The easy-to-use 3M™ Speedglas™ 100 welding helmet is the ideal “first” auto-darkening helmet for users who weld infrequently but can benefit from the ability to always see clearly with their welding protection in place.

Highly-affordable, it has excellent optical quality, reliable light-to-dark switching and can be used with most arc welding processes, such as stick (MMA), MIG/MAG and many TIG applications.

In addition to the black helmet, there are 12 graphic helmets available – all with specific identity. Also available is the 3M™ Speedglas™ 100 hard hat option for mandatory head protection areas.

## Features and Benefits:

- UV/IR protection shade 12 permanent
- Variable shade welding filter (100V)
- Three selectable sensitivity settings:
  - a normal setting used for most types of welding
  - a setting for other welders working nearby
  - a setting for low-current or stable arc welding
- Five user-selectable dark shades 8-12
- Switching time light-dark 0,1 ms



New headband with improved comfort & robustness\*

Lock into shade 3 (eg when grinding)\*

**3M™ Speedglas™  
100 Razor Dragon Welding Helmet**

Classification 1/1/2  
Conforms to EN 379

Dark to Light delay adjustment\*

Built in Mag-Lens Holder\*



HOR751120 3M™ Speedglas™ 100 Welding Helmet



### 3M™ Speedglas™ 100 Hard Hat Option

HOR783120

### 3M™ Peltor™ G3000 Hard Hat

The Peltor G3000 Hard Hat is produced in high quality UV-stabilised ABS plastic. This is one of the lightest hard hats on the market. It meets European standard EN 397 with approved extra requirement for low temperature (-30°C).



HOR750020 3M™ Speedglas™ 100V Filter

Viewing area: 44 x 93mm

For spares and accessories, see page 120

## 100 Welding Helmets Graphic Editions



### Helmets

- Speedglas 100 **Blaze** Helmet with 100V filter shade 3/8-12
- Speedglas 100 **Trojan Warrior** Helmet with 100V filter shade 3/8-12
- Speedglas 100 Helmet **Aces High** with 100V filter shade 3/8-12
- Speedglas 100 Helmet **Boneyard** with 100V filter shade 3/8-12
- Speedglas 100 Helmet **Ice Hot** with 100V filter shade 3/8-12
- Speedglas 100 Helmet **Razor Dragon** with 100V filter shade 3/8-12
- Speedglas 100 Helmet **Xterminator** with 100V filter shade 3/8-12
- Speedglas 100 Helmet **Raging Skull** with 100V filter shade 3/8-12
- Speedglas 100 Helmet **Steel Rose** with 100V filter shade 3/8-12
- Speedglas 100 Helmet **Skull Jewels** with 100V filter shade 3/8-12
- Speedglas 100 Helmet **Wild'n'Pink** with 100V filter shade 3/8-12
- Speedglas 100 Helmet **Steel Eyes** with 100V filter shade 3/8-12
- Speedglas 100 **Black** Helmet with 100V filter shade 3/8-12
- Speedglas 100 **Hard Hat** with 100V filter shade 3/8-12

### Code

- HOR751220
- HOR751620
- HOR751720
- HOR752320
- HOR752520
- HOR752420
- HOR752220
- HOR752620
- HOR751820
- HOR751920
- HOR752020
- HOR752120
- HOR751120
- HOR783120

# ▶▶ 3M Speedglas 100 Series Spares & Accessories

	Code
Speedglas 100V Auto-Darkening Filter Variable 3/8-12 (44x93mm)	HOR750020
<b>100 Protection Plates</b>	
100 Outer protection plate standard (pack of 10)	HOR776000
Inner protection plate (pack of 5)	HOR428000
Inner protection plate +1 shade (pack of 5)	HOR428020
Inner protection plate +2 shade (pack of 5)	HOR428040
<b>100 Sweatbands</b>	
Sweatband, towelling purple (pack of 2)	HOR167520
Sweatband, leather	HOR168000
Sweatband, fleecy cotton	HOR168010
<b>Magnifying Lenses</b>	
Magnifying lens 1.0	HOR171020
Magnifying lens 1.5	HOR171021
Magnifying lens 2.0	HOR171022
Magnifying lens 2.5	HOR171023
100 holder for magnifier	HOR171017
<b>100 Other Items</b>	
100 Silver front frame	HOR772000
100 Black front frame	HOR772001
Battery (pack of 2)	HOR422000
Headband including assembly parts	HOR705010
Assembly parts for headband	HOR706000
Speedyloop for Speedglas 100 Helmets with hard hat assembly	HOR547737
G3000 Safety hard hat white	3MG3001NUV-VI

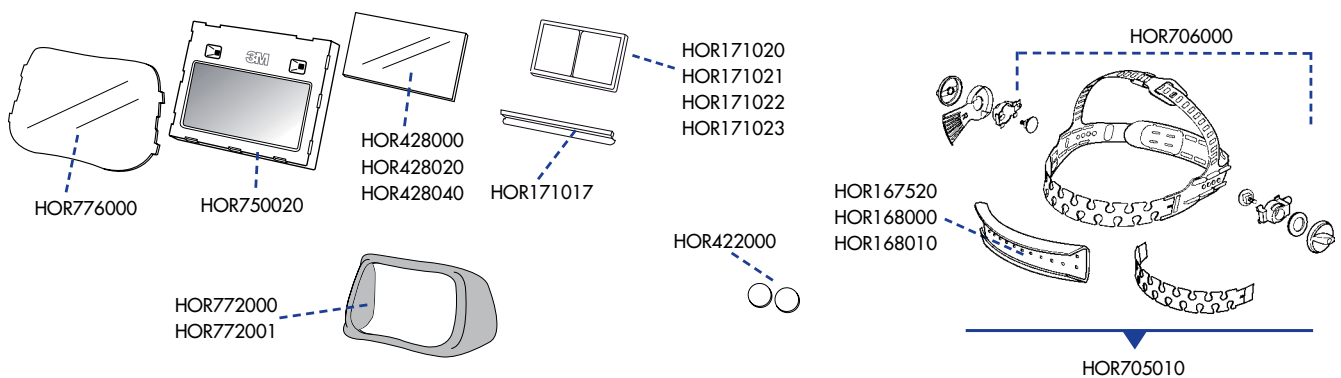

## The Super Light Welding Helmet

Welders have asked for two things in personal protection: lighter weight and more comfort. Challenges in designing this helmet were to significantly reduce weight, while maintaining the performance and protection that welders worldwide have come to expect in every Speedglas product. The result: a 360g auto-darkening welding helmet.

### Features and Benefits:

#### The Helmet: stronger & thinner

- Strong lightweight material with excellent protection and coverage
- Non-absorbent material that retains its performance in high humidity
- Back-and-forth adjustments allow for better fit and safety
- Ideal for tight spaces

#### Auto-Darkening Filter

- For most arc welding processes – such as MMA, MIG/MAG, TIG and plasma welding
- Viewing area 42 x 93mm
- Light state shade 3
- Variable dark shade 8-12
- Switching time light-dark 0,1 ms (+23°C)

#### The Headband: Fits better & feels cooler

- A pattern of holes for breathability and better conformity to the welder's head
- Accommodates smaller head sizes; its full range is from 50cm to 64cm



HOR701120 3M™ Speedglas™ SL Welding Helmet

Classification 1/1/1/2  
Conforms to EN 379, EN 175 level F



#### 3M™ Speedglas™ SL Common Consumables:

HOR700020	Speedglas SL Auto-Darkening Filter Variable 8-12
HOR726000	Speedglas SL Outer Protection Plate Standard (pack 5)
HOR428020	Speedglas Inner Protection Plate (ADF)
HOR168010	Sweatband, fleecy cotton



Speedglas SL Helmet with Auto-Darkening Filter Variable 8-12  
Speedglas SL Auto-Darkening Filter Variable 8-12 (42x93mm)

Code  
HOR701120  
HOR700020

## Code

### SL Protection Plates

- SL Outer protection plate standard (pack of 5)
- SL Outer protection plate scratch resistant (pack of 5)
- SL Inner Protection Plate (pack of 5)

HOR726000  
HOR727000  
HOR428000

### Other SL Spares and Consumables

- SL Helmet only without headband
- SL Welding Shield headband incl. assembly parts
- SL assembly parts for headband
- Welding filter battery holder
- Ear and neck protection in leather (3 parts)
- Sweatband, towelling
- Sweatband, leather
- Sweatband, fleecy cotton
- Neck protection TecaWeld
- Hood TecaWeld
- Magnifying lens 1.0
- Magnifying lens 1.5
- Magnifying lens 2.0
- Magnifying lens 2.5
- Holder for magnifier
- Battery (pack of 2)

HOR701190  
HOR705010  
HOR706000  
HOR731000  
HOR164005  
HOR167520  
HOR168000  
HOR168010  
HOR169001  
HOR169100  
HOR171020  
HOR171021  
HOR171022  
HOR171023  
HOR171031  
HOR422000

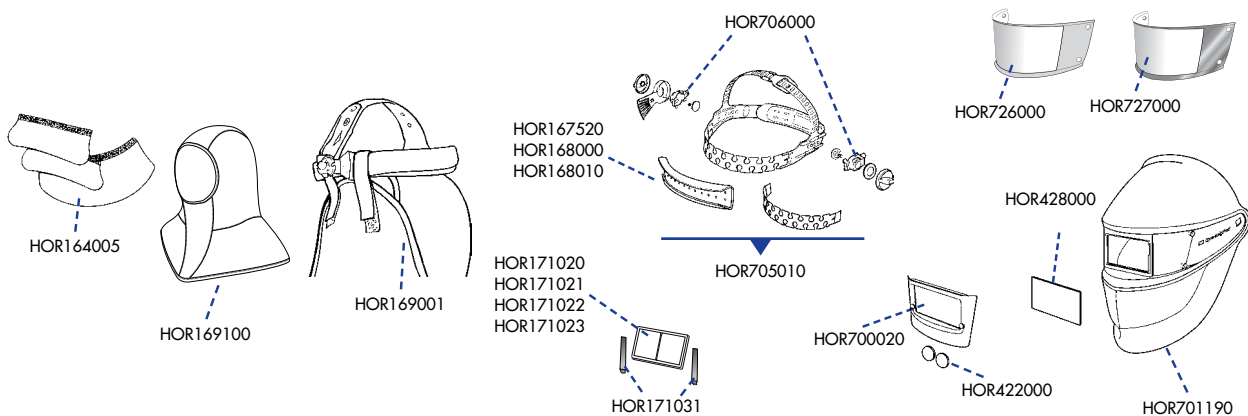





**3M**



**For more info & updates see  
[speedglas.weldspares.co.uk](http://speedglas.weldspares.co.uk)**

# ▶▶ 3M Speedglas

## General guide to respiratory protection



Welding generates harmful airborne particles and gases known to cause short and long term health problems for welders. Respiratory Protective Equipment (RPE) may be used to help reduce exposure to these hazards.

Two types of RPE are used to protect welders:

Filtering devices Filter contaminants from the air			Supplied air devices Use breathable quality air from a compressor
Disposable Respirators	Reusable Respirators	Powered Air Respirators	Compressed Air Regulator
			

Ventilation of the work area is important to help reduce the airborne concentration of contaminants and to ensure that the oxygen in the air is maintained at a safe level. Oxygen deficiency (i.e. <19.5% oxygen) can occur when welding in poorly ventilated areas or confined spaces. 3M™ do not offer RPE for use in oxygen deficient atmospheres.

The protection offered by RPE depends on the type of device and, if applicable, the filters fitted to it.

The levels of protection of 3M™ RPE for welders are listed in the table below. The Assigned Protection Factor (APF) for the equipment is published by the Health and Safety Executive in its book HSG-53. An APF of 20 indicates equipment that, when used properly, will reduce exposure by a factor of 20.

	Filtering devices				Supplied air device
<b>Model</b>	9925/9928	7500 with P2 filters	7500 with P3 filters	Adflo with Speedglas welding helmets	Fresh-air C with Speedglas welding helmets
<b>Type</b>	Disposable Respirator	Reusable Respirator	Reusable Respirator	Powered Air Respirator	Supplied Air Respirator
<b>APF</b>	10	10	20	20 or 40 <sup>†</sup>	20 or 40 <sup>†</sup>
<b>Additional protection</b>	Ozone up to 10xWEL* and nuisance level** organic vapours	Options available for Ozone up to 10xWEL* and nuisance level** gases/ vapours	Options available for Ozone up to 10xWEL* and nuisance level** gases/ vapours	Options available for gases and vapours	

\*WEL = Workplace Exposure Limit

\*\*Nuisance level = below WEL

<sup>†</sup>APF of 40 with 9100FX Air. APF of 20 with 9100 Air



## 1 - Filtering devices

Welders requiring respiratory protection need particle filters to capture metal fumes. In addition they may need gas and vapour filters depending on the type of work and the hazards generated. Harmful gases and vapours may be generated by ultraviolet light from the arc reacting with the air or by the burning of coatings or contamination on the metal.

**Filtering devices can be either disposable or reusable:**

Disposable respirators - e.g. 3M™ 9925/9928

Reusable half face masks - e.g. 3M™ 7500

Reusable powered respirators - e.g. 3M™ Adflo

The options for gas and vapour filters are:

Filter type	A	B	E
<b>Description</b>	Organic vapours, boiling point >65°C with good warning properties (taste and smell)	Inorganic gases/vapours with good warning properties (taste and smell)	Acid gases with good warning properties (taste and smell)
<b>Examples</b>	Many common solvents, degreasants and thinners	Chlorine	Hydrogen chloride

Note: Not all gases and vapours can be captured by filters. Check at [www.3M.co.uk/selectrespirator](http://www.3M.co.uk/selectrespirator)

## 2- Supplied air devices

3M™ Fresh-air C protects welders by feeding breathable quality air from a compressor into a 3M™ Speedglas™ welding helmet or a ClearVisor faceshield. It may be used when a supplied air device is preferred to a filtering device or against gases or vapours that cannot be filtered.

### 3M™ Air Quality Testing Service

The COSHH Regulations require that the air provided to supplied air devices should be of breathable quality and of sufficient, constant flow and pressure to provide adequate protection.

The 3M™ Air Quality Engineers will:

- ▶ test the air at several positions
- ▶ suggest measures and give sound advice if the air does not meet requirements
- ▶ issue a certificate should the air meet requirements for Breathable Quality Air

# ▶▶ 3M Speedglas 9100 Welding Adflo Powered Air Respirator Systems

## Improved Respiratory Protection - TH3

The exclusive “stackable” configuration of the Adflo turbo unit means that the gas filter can be stacked onto the particle filter for additional protection from specific organic, inorganic and acidic gases and vapours.

The Adflo Powered Air Respirator can be used with a 9100 welding helmet or a ClearVisor faceshield.

The new 3M™ Speedglas™ 9100 FX Air Welding Helmets offer the highest respiratory protection - TH3 and excellent vision in the flip-up mode. It readily connects to 2 different air delivery units:

- Adflo Powered Air Respirator
- Fresh-Air C Supplied Air Regulator

### Features and Benefits:

#### An Adaptable System

- With the right type of filter, Adflo effectively protects against both particles and gases – all in one system. The filters can be replaced selectively: you don't need to change all filters at the same time

#### Filter Indicator

- As soon as you turn on your Adflo powered air respirator a display indicates the status of the particle filter

#### Airflow

- For hot humid jobs the user can increase the airflow from 170 l/min to 200 l/min



#### 3M™ Speedglas™ 9100FX Air Welding System

Assigned protection factor 40  
Conforms to EN 12941 (TH 3)

### Main Systems Part Numbers

HOR546605	9100FX Helmet with 9100V ADF and Adflo
HOR546615	9100FX Helmet with 9100X ADF and Adflo
HOR546625	9100FX Helmet with 9100XX ADF and Adflo
HOR566605	9100 Helmet with 9100V ADF and Adflo
HOR566615	9100 Helmet with 9100X ADF and Adflo
HOR566625	9100 Helmet with 9100XX ADF and Adflo

#### Also available:

3M™ Speedglas™ 9100 Air Welding System  
Assigned protection factor 20



### Common Consumables:

HOR837010	Adflo Particle Filter
HOR836010	Adflo Prefilter (pack 5)
HOR837242	Adflo Gas Filter A1B1E1
HOR837110	Odour Filter, Holder & Pad
HOR837120	Replacement Odour Filter Pad
HOR836000	Spark Arrestor
HOR834016	Self-Adjusting Breathing Tube
HOR834017	Heavy Duty Breathing Tube

# 3M Speedglas ▶▶ 9100 Welding Adflo Powered Air Respirator Systems



9100FX Air



9100 Air

## 9100 Adflo Systems with Auto-Darkening Filter (complete systems)



9100V Air shade 5, 8, 9-13 with Adflo Powered Respirator  
9100X Air shade 5, 8, 9-13 with Adflo Powered Respirator  
9100XX Air shade 5, 8, 9-13 with Adflo Powered Respirator

Code

HOR566605  
HOR566615  
HOR566625



9100V FX Air shade 5, 8, 9-13 with Adflo Powered Respirator  
9100X FX Air shade 5, 8, 9-13 with Adflo Powered Respirator  
9100XX FX Air shade 5, 8, 9-13 with Adflo Powered Respirator

HOR546605  
HOR546615  
HOR546625

## 9100 Adflo Systems without Auto-Darkening Filter\*

9100 Air Helmet with Adflo Powered Respirator  
9100 FX Air Helmet with Adflo Powered Respirator

HOR566600  
HOR546600

\*Combine with choice of Auto-Darkening Filters from:

## 9100 Auto-Darkening Filters (ADFs)

9100V filter shade 5, 8, 9-13 (45x93mm)  
9100X filter shade 5, 8, 9-13 (54x107mm)  
9100XX filter shade 5, 8, 9-13 (73x107mm)

HOR500005  
HOR500015  
HOR500025

# ▶▶ 3M Speedglas ClearVisor Faceshields for Adflo Powered Air Respirator



Code

## ClearVisor Adflo Systems\*

**\*Choose ClearVisor option below and combine with Adflo Turbo Unit**

ClearVisor Faceshield with polycarbonate visor	HOR899030
ClearVisor Faceshield with acetate visor	HOR899031
ClearVisor Faceshield with shade DIN5 visor	HOR899035

## Spares & Accessories for ClearVisor

Headband with air duct	HOR803010
Headband without air duct	HOR803060
Face seal	HOR804005
Velcro attachment system (pack of 2)	HOR891013
ClearVisor, polycarbonate (excl. brow protection)	HOR899040
ClearVisor, acetate (excl. brow protection)	HOR899041
Visor shade DIN5 (excl. brow protection)	HOR899045
Brow protection	HOR899051
Protection film (pack of 5)	HOR899060

## Adflo Turbo Unit

See page 129 for details

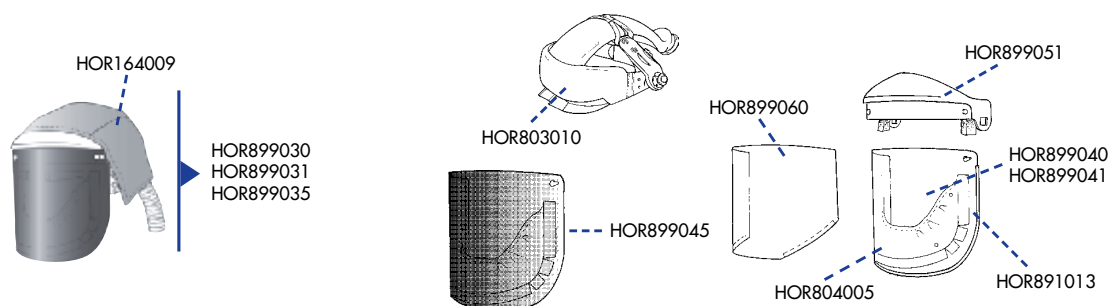



## Adflo Powered Air Turbo Unit

- Adflo PAPR (standard battery)
- Adflo PAPR (heavy duty battery)
- Adflo PAPR (standard battery) - No belt / No battery charger
- Adflo powered air turbo unit only

- Code
- HOR832530
  - HOR832531
  - HOR832510
  - HOR832000

## Air Hoses

- Air hose, self-adjusting QRS HOR834016
- Air hose, heavy-duty rubber QRS HOR834017
- Air hose cover, flame resistant HOR834018

## Filters

- Prefilter (pack of 5) HOR836010
- Particle filter P SL HOR837010
- Odour filter holder and pad HOR837110
- Replacement odour filter pad HOR837120
- Gas filter A1B1E1 HOR837242
- Adflo Gas filter kit, A1B1E1 filter and Heavy-Duty battery HOR837300
- Gas filter A2 HOR837542
- Air flow indicator HOR838020
- Filter cover HOR838030
- Spark arrestor HOR836000

## Batteries / Chargers

- Battery charger for Adflo HOR833101
- Battery, standard HOR837620
- Battery Heavy-Duty HOR837621
- Charger - 6 position UK HOR833208

## Other

- Adflo Backpack HOR806020
- Belt HOR835000
- Front part of belt HOR835005
- Storage bag HOR837000

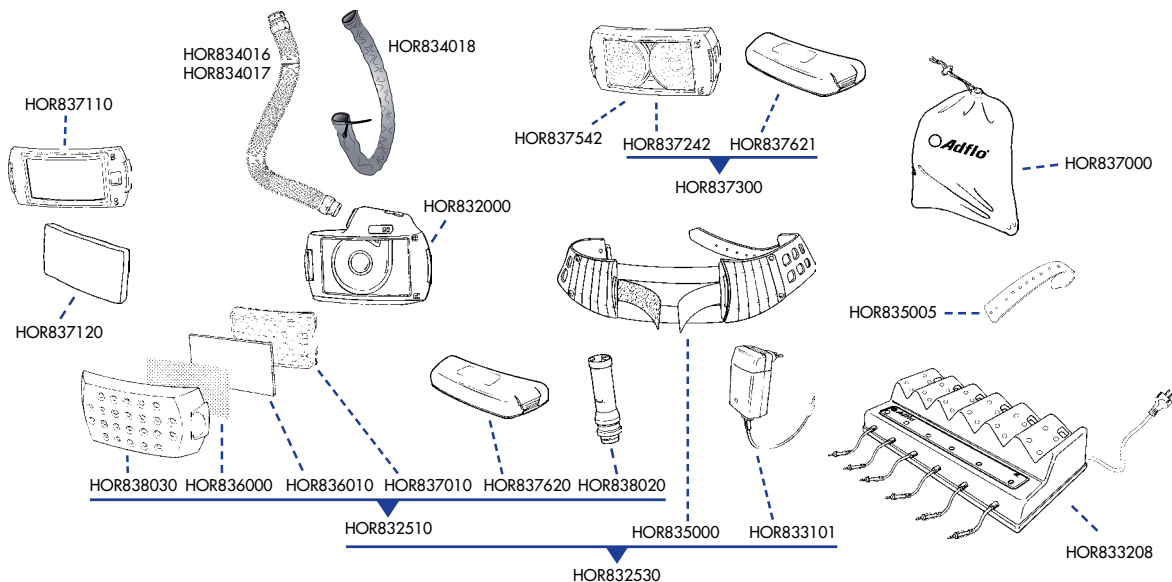

# ▶▶ 3M Speedglas 9100 and 9100FX Air Helmets - Spares & Accessories



9100 Air



9100FX Air

Combine with the Adflo Turbo Unit or Fresh-air C Regulator for a Respiratory Protection System

### 9100 Air Helmets without Auto-Darkening Filter\*

9100FX Air welding helmet for respiratory protection  
9100 Air welding helmet for respiratory protection

Code  
HOR542800  
HOR562800

\*Combine with choice of Auto-Darkening Filters from:

### 9100 Auto-Darkening Filters (ADFs)

9100V filter shade 5, 8, 9-13 (45x93mm)  
9100X filter shade 5, 8, 9-13 (54x107mm)  
9100XX filter shade 5, 8, 9-13 (73x107mm)

HOR500005  
HOR500015  
HOR500025

### 9100 Air

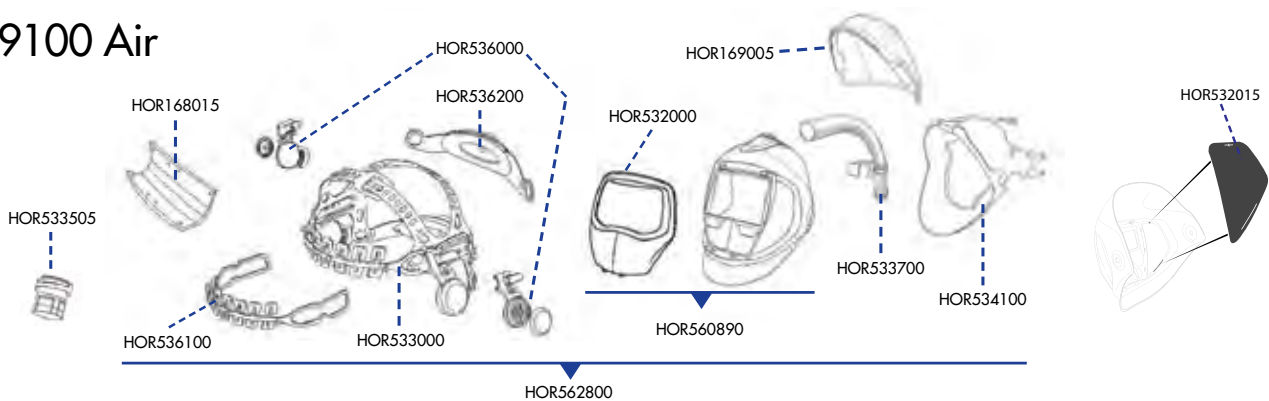

### 9100FX Air

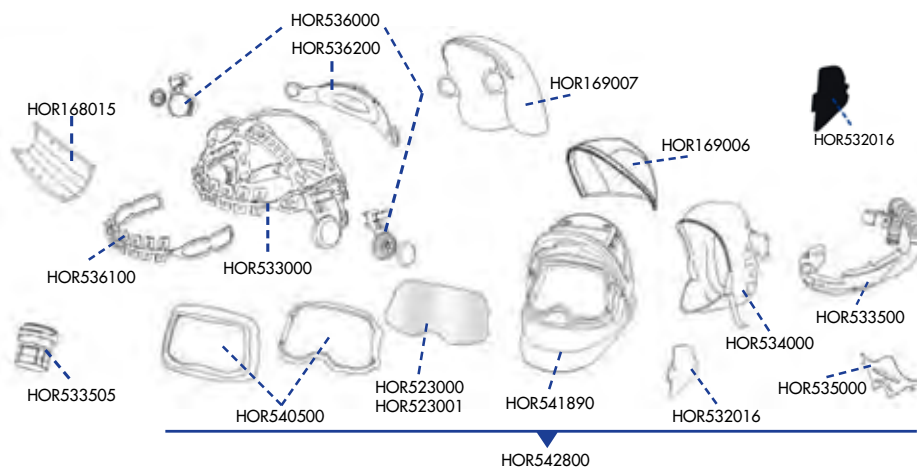



# 3M Speedglas▶▶

## 9100 and 9100FX Air Helmets - Spares & Accessories

### 9100 Outer Protection Plates

	Code
Outer protection plate standard (pack of 10)	HOR526000
Outer protection plate scratch resistant (pack of 10)	HOR527000
Outer protection plate heat resistant (pack of 10)	HOR527070

### 9100 Inner Protection Plates

9100V Inner protection plate (pack of 5)	HOR528005
9100X Inner protection plate (pack of 5)	HOR528015
9100XX Inner protection plate (pack of 5)	HOR528025

### 9100 Sweatband

9100 Sweatband (pack of 3)	HOR168015
----------------------------	-----------

### 9100 Head, Ear and Throat Protection

9100 Air Extended head protector	HOR169005
9100 Air and 9100 FX Air Extended throat and ear protector	HOR169010
9100 Air and 9100 FX Hood throat/Head protector	HOR169100
9100 FX Air head cover small	HOR169006
9100 FX Air head cover large	HOR169007

### 9100 Other Items

9100 FX Air Welding Helmet without headband, face seal and air-duct	HOR541890
9100 Air Welding Helmet without headband, face seal and air-duct	HOR560890
9100 FX Air Face Seal	HOR534000
9100 Air Face Seal	HOR534100
9100 FX Visor plate (pack of 5)	HOR523000
9100 FX Visor plate Anti-Fog (pack of 5)	HOR523001
9100 FX Airduct assembly	HOR533500
9100 FX Front cover kit	HOR540500
9100 FX SideWindow Cover plate, 2 pairs	HOR532016
Air Deflector for 9100 FX Air Welding Helmet	HOR535000
Back part Air Duct for 9100 Air Welding Helmet	HOR533700
9100 Headband, complete	HOR533000
9100 Headband pivot mechanism, both sides	HOR536000
9100 Headband front part	HOR536100
9100 Headband back part	HOR536200
9100 Battery holder (pack of 2)	HOR531000
Battery (pack of 2)	HOR422000

### Accessories

Adaptor for 9100 FX Air and 9100 Air Helmets with Old Breathing tube	HOR533505
Adaptor for 9000 Welding Helmets with New QRS Breathing tubes	HOR533506
New 9100 product carry bag	HOR790101

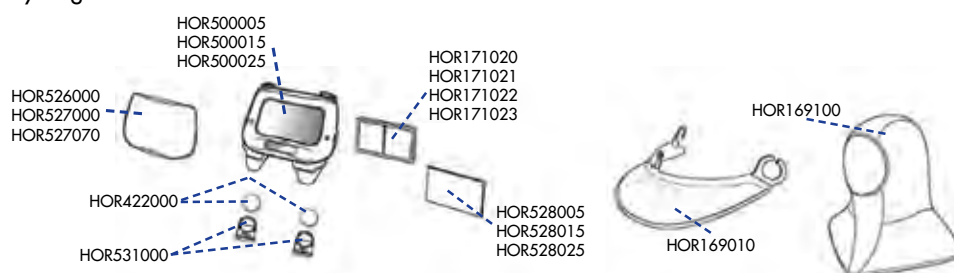

# ▶▶ 3M Speedglas

## Compatibility of 3M Air Delivery Units Headtops

The new welding helmets and faceshields from 3M feature the QRS type of breathing tube (Quick Release Swivel), which enables one-handed connection and release. Old type of breathing tubes (non QRS) can be used by adding the helmet breathing tube adapter (part no 53 35 05).

The new type of QRS breathing tubes are also approved for 3M™ Speedglas™ Welding Helmet Series 9000 and 3M™ Speedglas™ Protective Visors by adding a specific helmet breathing tube adapter (part no 53 35 06).

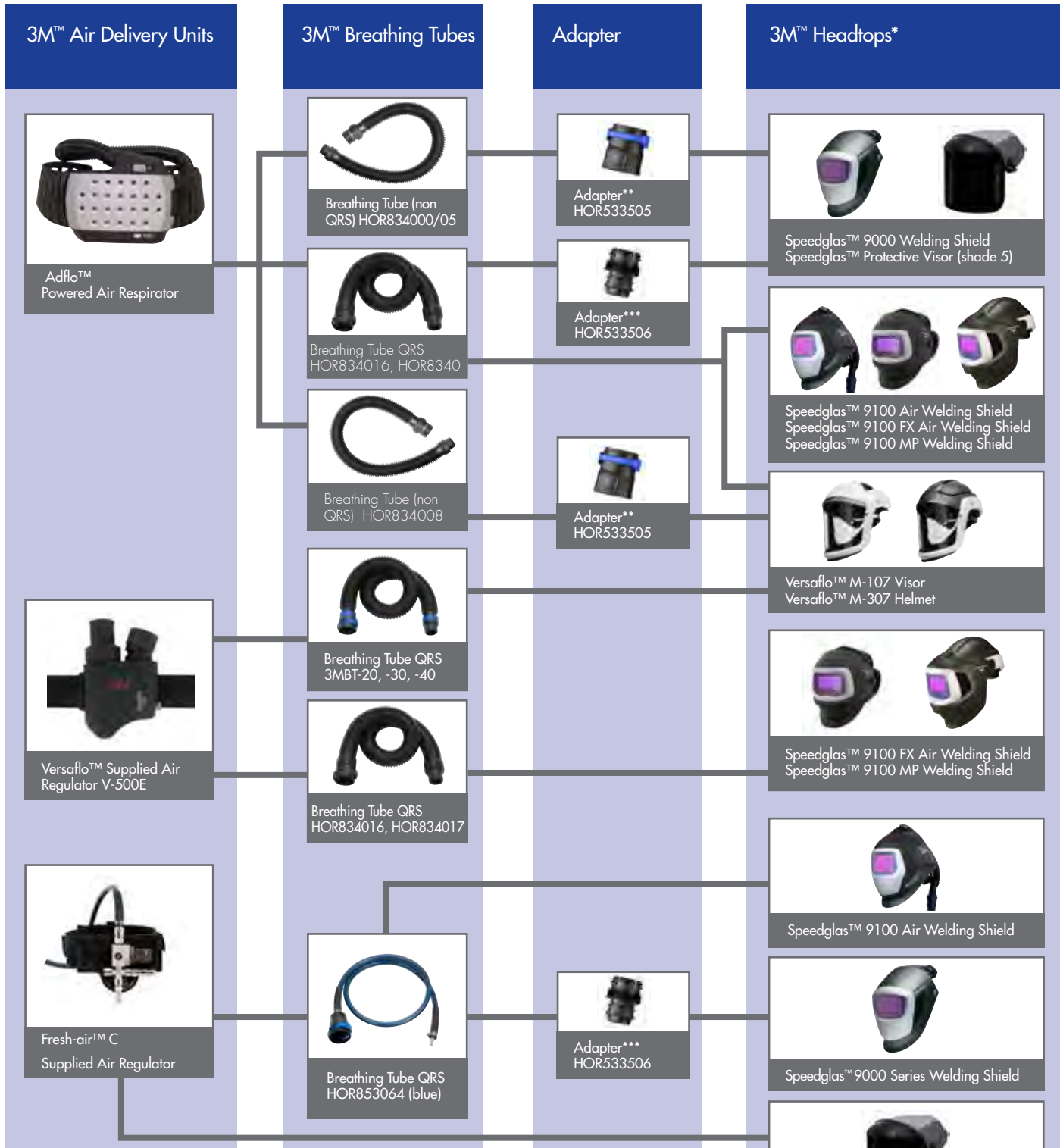

\* The Speedglas welding helmet series 9100 replaces most of the Speedglas welding helmet series 9000. Accessories and spare parts for the 9000 helmets will be available for 3-5 years.

\*\* The protection class of Speedglas welding helmet 9100 FX Air is reduced to TH2 when the adapter (53 35 05) is used.

\*\*\* When you buy a new complete respirator or regulator with the new QRS breathing tube, it includes the adapter 53 05 06, needed for connecting the Speedglas welding helmet series 9000 and Speedglas visors to the new type of breathing tube.

# 3M Speedglas ▶▶ 9100 Fresh-air C™ Compressed Air Regulator Systems



For highly-contaminated welding environments, you may use the 3M™ Fresh-air C compressed air respiratory system with a 9100 welding helmet or a ClearVisor faceshield. The belt-mounted regulator connects to an approved air hose with a quick release connector system.

## Features and Benefits:

### Adjustable Air Flow

- The lightweight belt-mounted regulator allows the user to adjust the airflow from 160 to 300 litres per minute, making Fresh-air C ideal for hot and strenuous work
- Air pressure 4-10 bar
- The exclusive airflow pattern evenly distributes filtered air throughout the entire breathing zone of the helmet
- The soft flexible face seal creates a positive pressure environment within the helmet, keeping the surrounding pollutants at bay

### Comfort Belt

- Polypropylene 78 -150cm

### Air Supply

- The air supply must be air of breathable quality meeting the requirements of EN12021
- The 3M™ Aircare™ filtration systems may be used to remove particles and odours.

## Ranges

HOR568800	3M™ Speedglas™ 9100 Air with Fresh-air C Regulator without auto-darkening filter
HOR548800	3M™ Speedglas™ 9100FX Air with Fresh-air C Regulator without auto-darkening filter



### 3M™ Speedglas™ 9100 Fresh-air C™ System

Conforms to EN14594 Class 2B  
Assigned protection factor 20



### 3M™ Speedglas™ 9100FX Fresh-air C™ System

Conforms to EN14594 Class 3B  
Assigned protection factor 40

## Common Consumables:

HOR806000	Comfort Belt
HOR853064	Air Hose
HOR534100	Face Seal
HOR834016	Self-Adjusting Breathing Tube
HOR834017	Heavy Duty Breathing Tube
HOR526000	Outer Protection Plate standard (pack 5)
HOR168015	9100 Sweatband (pack 3)

# ▶▶ 3M Speedglas 9100 Fresh-air C™ Compressed Air Regulator Systems



9100FX Air



9100 Air

## 9100 Fresh-air C Systems with Auto-Darkening Filter (complete systems)



9100V Air shade 5, 8, 9-13 with Fresh-air C Regulator  
 9100X Air shade 5, 8, 9-13 with Fresh-air C Regulator  
 9100XX Air shade 5, 8, 9-13 with Fresh-air C Regulator

Code

HOR568805  
 HOR568815  
 HOR568825



9100V FX Air shade 5, 8, 9-13 with Fresh-air C Regulator  
 9100X FX Air shade 5, 8, 9-13 with Fresh-air C Regulator  
 9100XX FX Air shade 5, 8, 9-13 with Fresh-air C Regulator

HOR548805  
 HOR548815  
 HOR548825

## 9100 Fresh-air C Systems without Auto-Darkening Filter\*

9100 Air Helmet with Fresh-air C Regulator  
 9100 FX Air Helmet with Fresh-air C Regulator

HOR568800  
 HOR548800

\*Combine with choice of Auto-Darkening Filters from:

### 9100 Auto-Darkening Filters (ADFs)

9100V filter shade 5, 8, 9-13 (45x93mm)  
 9100X filter shade 5, 8, 9-13 (54x107mm)  
 9100XX filter shade 5, 8, 9-13 (73x107mm)

HOR500005  
 HOR500015  
 HOR500025

# 3M Speedglas ►► ClearVisor Faceshields for Fresh-air C™ Compressed Air Regulator



Code

## ClearVisor Fresh-air C Systems\*

\*Choose ClearVisor option below and combine with Fresh-Air C Regulator

ClearVisor Faceshield with polycarbonate visor	HOR899130
ClearVisor Faceshield with acetate visor	HOR899131
ClearVisor Faceshield with shade DIN5 visor	HOR899135

## Spares & Accessories for ClearVisor

Headband without air duct	HOR803060
Face seal	HOR804005
Air hose with nipple, silencer and fastening details	HOR853056
Velcro attachment system (pack of 2)	HOR891013
ClearVisor polycarbonate with face seal	HOR899140
ClearVisor acetate with face seal and air hose	HOR899141
ClearVisor shade DIN5 with face seal and air hose	HOR899145
Brow protection	HOR899151
Protection film (pack of 5)	HOR899060

## Fresh-air C Supplied Air Regulator

See page 136 for details

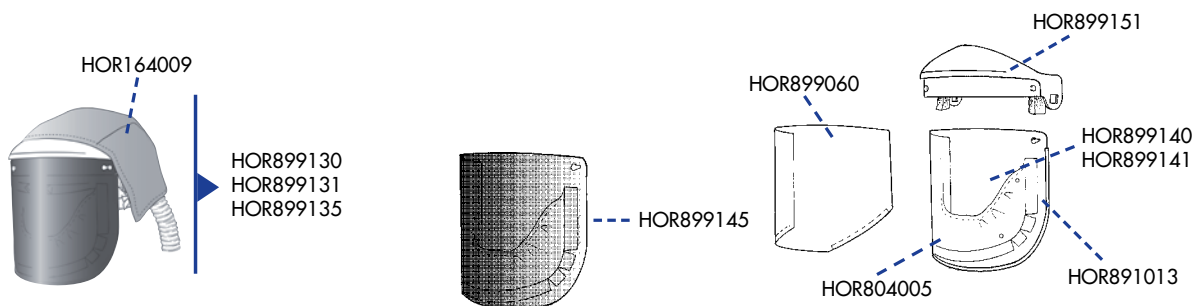

# ▶▶ 3M Speedglas Fresh-air C™ Compressed Air Regulator



Code

## Fresh-air C Supplied Air Regulator

Fresh-air C variable air flow regulator, low pressure alarm, air hose, comfort belt and carry/air flow test bag (complete system)	HOR852016
Fresh-air C variable air flow regulator with low pressure alarm, air hose and carry/air flow test bag (no belt)	HOR852116
Fresh-air C variable air flow regulator with low pressure alarm, comfort belt and carry/air flow test bag (no air hose)	HOR852010
Fresh-air C variable air flow regulator with low pressure alarm and carry/air flow test bag (no air hose / no belt)	HOR852110
Comfort belt	HOR806000
Air hose	HOR853062
Quick connection CEJN 220 1/4	HOR852153
Nipple air hose CEJN 220 1/4	HOR852158
Nipple regulator CEJN 342	R530-12-53P3
Air hose 10m incl. nipples and quick connections	HOR854010
Approved air hose 10m	R308-00-30P
Carry/air flow test bag	HOR857000
Aircare filtration unit - Wall unit	3MACU-01
Aircare filtration unit - Floor unit	3MACU-02

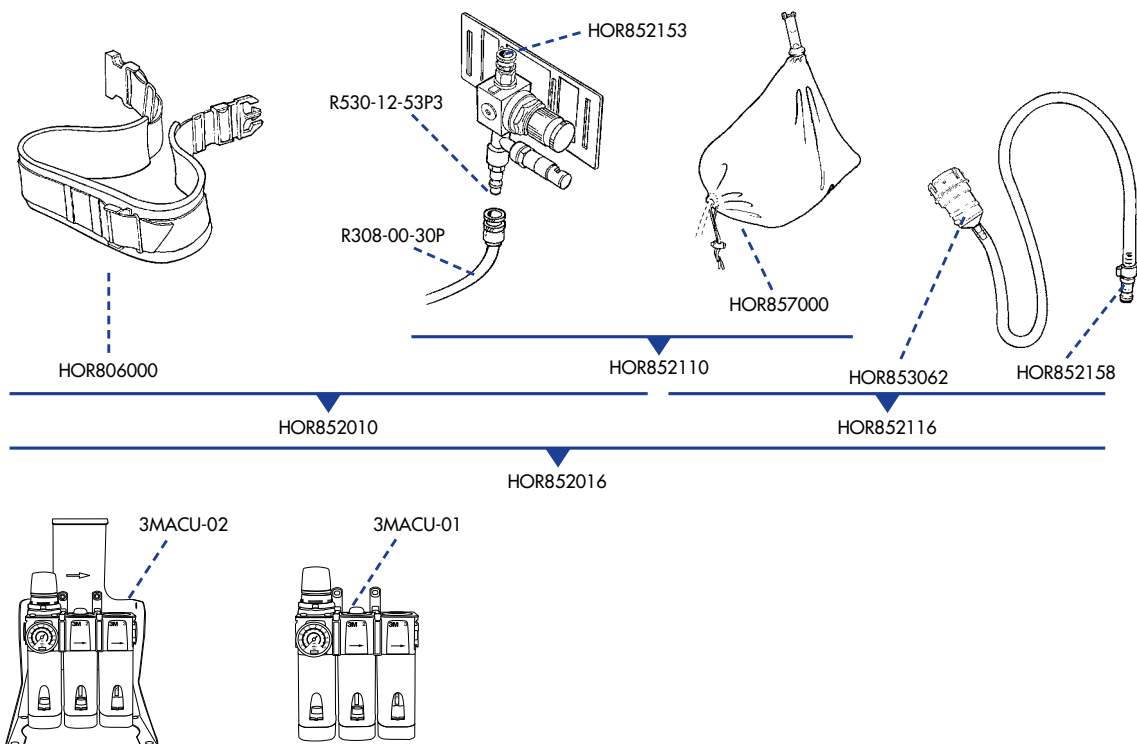

# 3M Speedglas ▶▶ 9100 MP Welding & Safety

Until now, a welder's options for head and respiratory protection have been limited. Introducing the 3M™ Speedglas™ 9100 MP (Multi-Protection) Welding & Safety Helmet: uncompromising and comfortable, all-in-one, welding protection for highly demanding environments.

## Features and Benefits:

- 100% compatible with all of the latest 3M™ Speedglas™ 9100 Series Auto-Darkening Filters, including the top-of-the-line 9100XX Filter.

- A big (17x10 cm), curved, protective visor with excellent views up, down and peripherally. Meets EN 166:B for high speed particle protection making it suitable for grinding



- Two proprietary shade 5 passive SideWindows add peripheral welding vision.

- The top shell is made from heat resistance polycarbonate and meets the latest EN 379 standard for industrial safety helmets. An optional, high-visibility, aluminum fabric reflects hot sunlight and welding heat.



- Designed to take one of our optional 3M™ Peltor™ Earmuffs: low-profile hearing protection with liquid/foam ear cushions and high-visibility orange housings.

Approved with 3M™ Adflo™ Powered Air Respirator and 3M™ Versaflo™ V-500E Supplied Air Regulator

## Main Systems Part Numbers

HOR572800	9100 MP Welding & Safety Helmet without Welding Filter
HOR576600	9100 MP Welding & Safety Helmet and Adflo without Welding Filter
HOR576605	9100 MP Welding & Safety Helmet with 9100V Welding Filter and Adflo
HOR576615	9100 MP Welding & Safety Helmet with 9100X Welding Filter and Adflo
HOR576625	9100 MP Welding & Safety Helmet with 9100XX Welding Filter and Adflo
HOR578800	9100 MP Welding & Safety Helmet and V-500E without Welding Filter
HOR578805	9100 MP Welding & Safety Helmet with 9100V Welding Filter and V-500E
HOR578815	9100 MP Welding & Safety Helmet with 9100X Welding Filter and V-500E
HOR578815	9100 MP Welding & Safety Helmet with 9100XX Welding Filter and V-500E



# ▶ 3M Speedglas 9100 MP Welding & Safety

Part No.	Description	Part No.	Description	Part No.	Description
HOR576600	Speedglas welding helmet 9100 MP without welding filter, with Adflo powered air respirator.	HOR578800	Speedglas welding helmet 9100 MP without welding filter, with Versaflo supplied air regulator V-500E	HOR579015	Speedglas welding helmet 9100 MP with 9100X welding filter & breathing tube
HOR576605	Speedglas welding helmet 9100 MP with 9100V filter, with Adflo powered air respirator.	HOR578805	Speedglas welding helmet 9100 MP with 9100V filter, with Versaflo supplied air regulator V-500E	HOR579025	Speedglas welding helmet 9100 MP with 9100XX filter and breathing tube
HOR576615	Speedglas welding helmet 9100 MP with 9100X filter, with Adflo powered air respirator.	HOR578815	Speedglas welding helmet 9100 MP with 9100X welding filter, with Versaflo supplied air regulator V-500E		
HOR576625	Speedglas welding helmet 9100 MP with 9100XX filter, with Adflo powered air respirator.	HOR578825	Speedglas welding helmet 9100 MP with 9100XX filter, with Versaflo supplied air regulator V-500E		

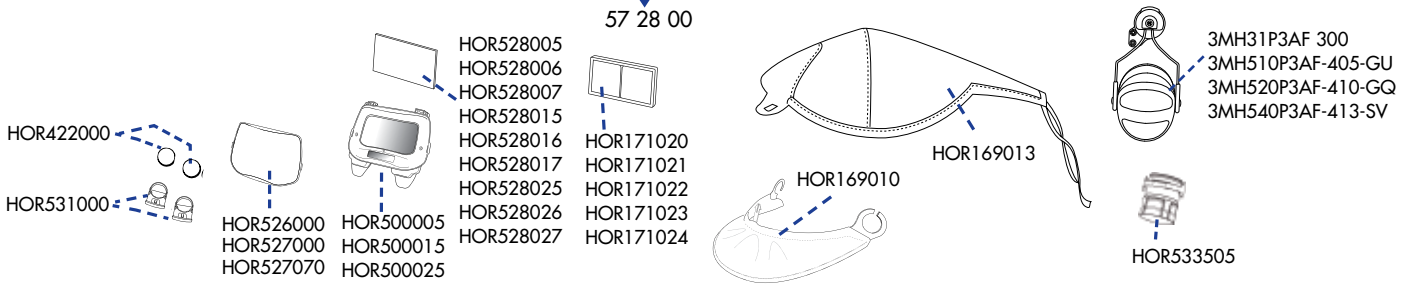
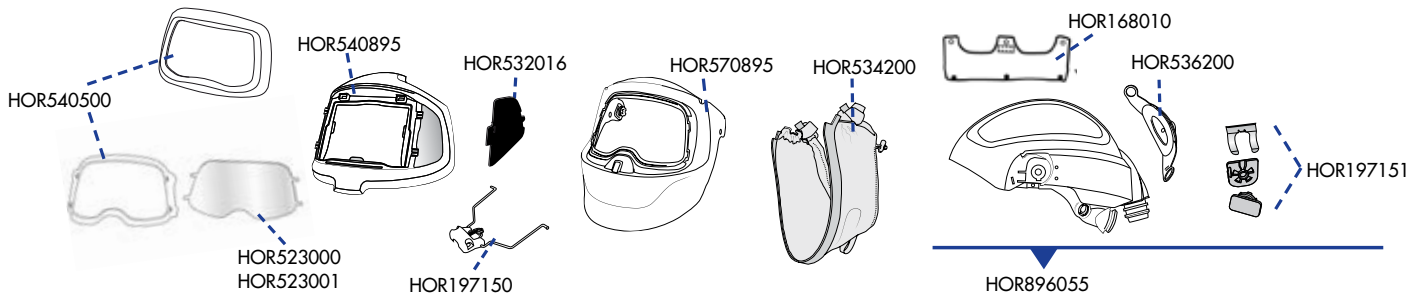

Code	Description	Code	Description	Code	Description
HOR168010	Sweatband fleecy cotton	HOR527000	Outer protection plate, extra scartch resistant	HOR570895	Inner shield
HOR169010	Neck protection black	HOR527070	Outer protection plate, heat resistant	HOR572800	Speedglas welding & safety helmet 9100MP without welding filter
HOR169013	Safety Helmet Cover 9100MP	HOR528005	Inner cover plate for 9100V filter, pk 5, plate marking 117X50	HOR896055	Safety helmet incl. pivot kit
HOR171020	Magnifying lens 1.0	HOR528015	Inner cover plate for 9100X filter, pk 5, plate marking 117X61	3M-350	Versaflo head suspension M-300 (not shown above)
HOR171021	Magnifying lens 1.5	HOR528025	Inner cover plate for 9100XX filter, pk 5 plate marking 117X77	3MH53031P3AF300	
HOR171022	Magnifying lens 2.0.	HOR531000	Battery holder pk 2	Peltor Hearing Protector H31, with helmet	
HOR171023	Magnifying lens 2.5.	HOR532016	Side window cover plates	3MH510P3AF-405-GU	
HOR171024	Magnifying lens 3.0	HOR532016	Welding helmet adaptor when using old breating tube type (non QRS)	Peltor Hearing Protector Optime I, with helmet	
HOR197150	Flip-up mechanism	HOR540500	Front cover kit	3MH520P3AF-410-GG	
HOR197151	Pivot kit	HOR570495	Outer shield	Peltor Hearing Protector Optime II, with helmet	
HOR422000	Battery, pkg of 2.			3MH540P3AF-413-SV	
HOR500005	Speedglas welding filter 9100V.			Peltor Hearing Protector Optime III, with helmet	
HOR500015	Speedglas welding filter 9100X				
HOR500025	Speedglas welding filter 9100XX.				
HOR523000	Visor plate, standard, pkg of 5.				
HOR523001	Visor plate, anti-fog, pkg of 5				
HOR526000	Outer protection				



# 3M Speedglas ▶▶ 9100 and 9100FX Air Helmets - Spares & Accessories



9100 Air



9100FX Air

Combine with the Adflo Turbo Unit or Fresh-air C Regulator for a Respiratory Protection System

### 9100 Air Helmets without Auto-Darkening Filter\*

9100FX Air welding helmet for respiratory protection

9100 Air welding helmet for respiratory protection

Code

HOR542800

HOR562800

\*Combine with choice of Auto-Darkening Filters from:

### 9100 Auto-Darkening Filters (ADFs)

9100V filter shade 5, 8, 9-13 (45x93mm)

9100X filter shade 5, 8, 9-13 (54x107mm)

9100XX filter shade 5, 8, 9-13 (73x107mm)

HOR500005

HOR500015

HOR500025

### 9100 Air

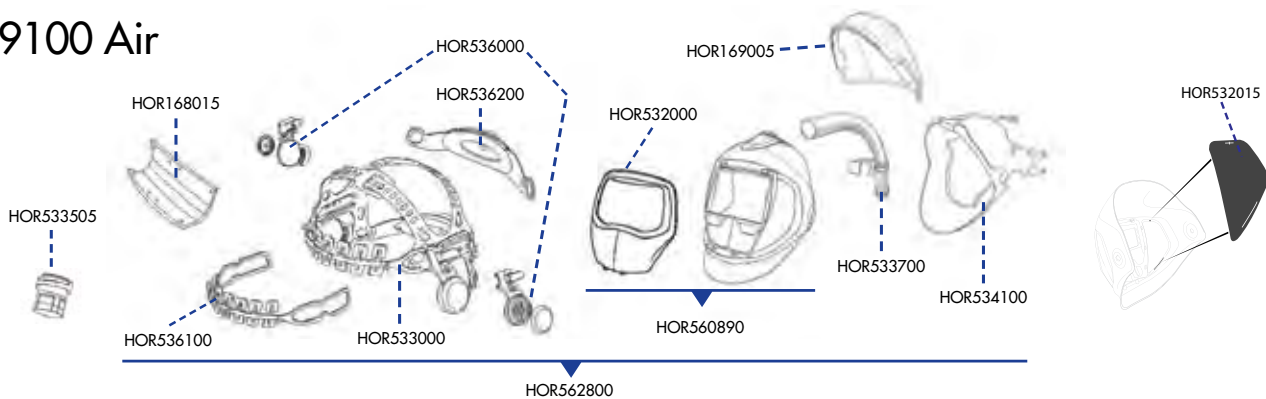

### 9100FX Air

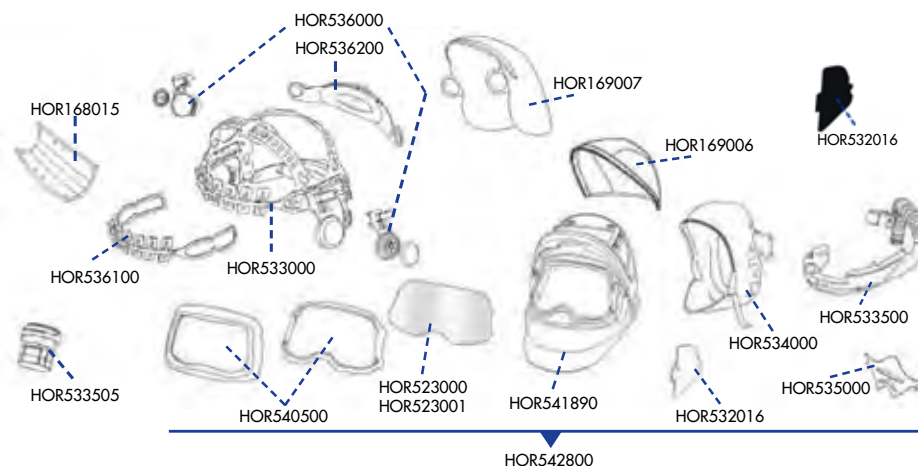

# ▶ 3M Speedglas 9100 and 9100FX Air Helmets - Spares & Accessories

## 9100 Outer Protection Plates

	Code
Outer protection plate standard (pack of 10)	HOR526000
Outer protection plate scratch resistant (pack of 10)	HOR527000
Outer protection plate heat resistant (pack of 10)	HOR527070

## 9100 Inner Protection Plates

9100V Inner protection plate (pack of 5)	HOR528005
9100X Inner protection plate (pack of 5)	HOR528015
9100XX Inner protection plate (pack of 5)	HOR528025

## 9100 Sweatband

9100 Sweatband (pack of 3)	HOR168015
----------------------------	-----------

## 9100 Head, Ear and Throat Protection

9100 Air Extended head protector	HOR169005
9100 Air and 9100 FX Air Extended throat and ear protector	HOR169010
9100 Air and 9100 FX Hood throat/Head protector	HOR169100
9100 FX Air head cover small	HOR169006
9100 FX Air head cover large	HOR169007

## 9100 Other Items

9100 FX Air Welding Helmet without headband, face seal and air-duct	HOR541890
9100 Air Welding Helmet without headband, face seal and air-duct	HOR560890
9100 FX Air Face Seal	HOR534000
9100 Air Face Seal	HOR534100
9100 FX Visor plate (pack of 5)	HOR523000
9100 FX Visor plate Anti-Fog (pack of 5)	HOR523001
9100 FX Airduct assembly	HOR533500
9100 FX Front cover kit	HOR540500
9100 FX SideWindow Cover plate, 2 pairs	HOR532016
Air Deflector for 9100 FX Air Welding Helmet	HOR535000
Back part Air Duct for 9100 Air Welding Helmet	HOR533700
9100 Headband, complete	HOR533000
9100 Headband pivot mechanism, both sides	HOR536000
9100 Headband front part	HOR536100
9100 Headband back part	HOR536200
9100 Battery holder (pack of 2)	HOR531000
Battery (pack of 2)	HOR422000

## Accessories

Adaptor for 9100 FX Air and 9100 Air Helmets with Old Breathing tube	HOR533505
Adaptor for 9000 Welding Helmets with New QRS Breathing tubes	HOR533506
New 9100 product carry bag	HOR790101

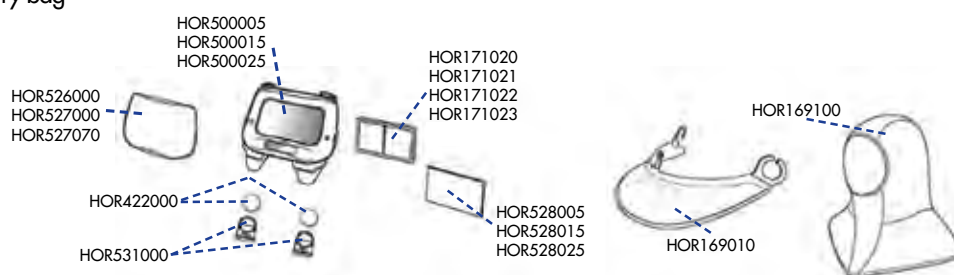

## Adflo Powered Air Respirator

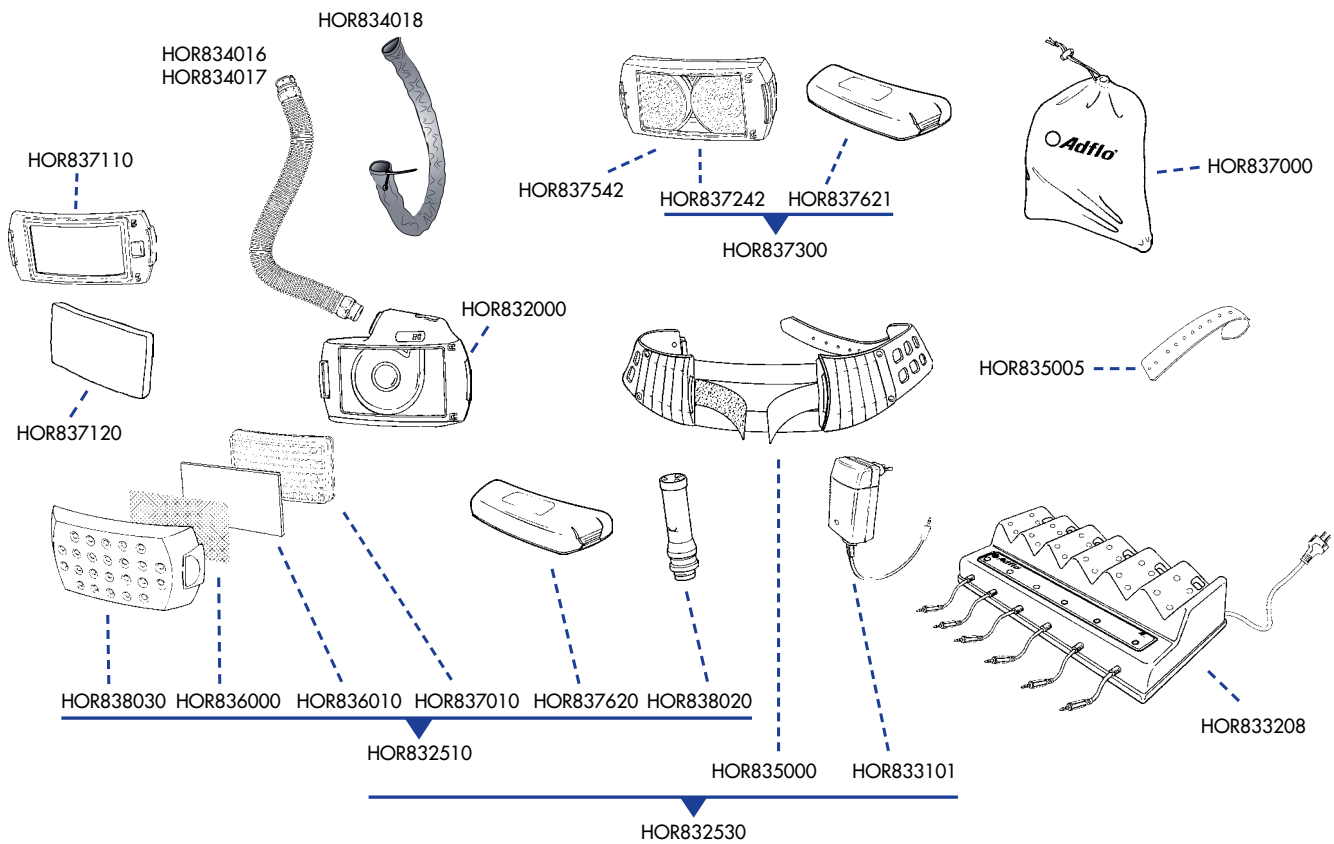

Code	Description	Code	Description	Code	Description
HOR832000	Adflo powered air turbo unit only	HOR834017	Breathing tube heavy duty rubber QRS	HOR837120	Replacement odour filter pad
HOR832510	Adflo PAPR (standard battery) - No belt / No battery charger	HOR834018	Breathing tube cover, flame resistant	HOR837242	Gas filter A1B1E1
HOR832530	Adflo PAPR (standard battery)	HOR835000	Belt	HOR837300	Gas filter kit, A1B1E1 filter and Heavy-Duty battery
HOR832531	Adflo PAPR (heavy duty battery)	HOR835005	Belt, front part	HOR837542	Gas filter A2
HOR833101	Battery charger	HOR836000	Spark arrester	HOR837620	Battery (standard)
HOR833208	Charge device 6 pos. UK	HOR836010	Prefilter (pack of 5)	HOR837621	Battery Heavy-Duty
HOR834016	Breathing tube (self-adjusting QRS)	HOR837000	Storage bag	HOR838020	Air flow indicator
		HOR837010	Particle Filter P SL	HOR838030	Filter cover
		HOR837110	Odour filter holder and pad		

### Accessory kit Speedglas for Adflo

Code HOR830002 includes:

- 2 pcs of sweatband (HOR168010)
- 10 pcs of Outer protection plates (HOR426000)
- 1 face seal (HOR434000)
- 5 pcs of prefilter (HOR836010)
- 1 particle filter (HOR837010)



### Fresh-air C Compressed Air Regulator

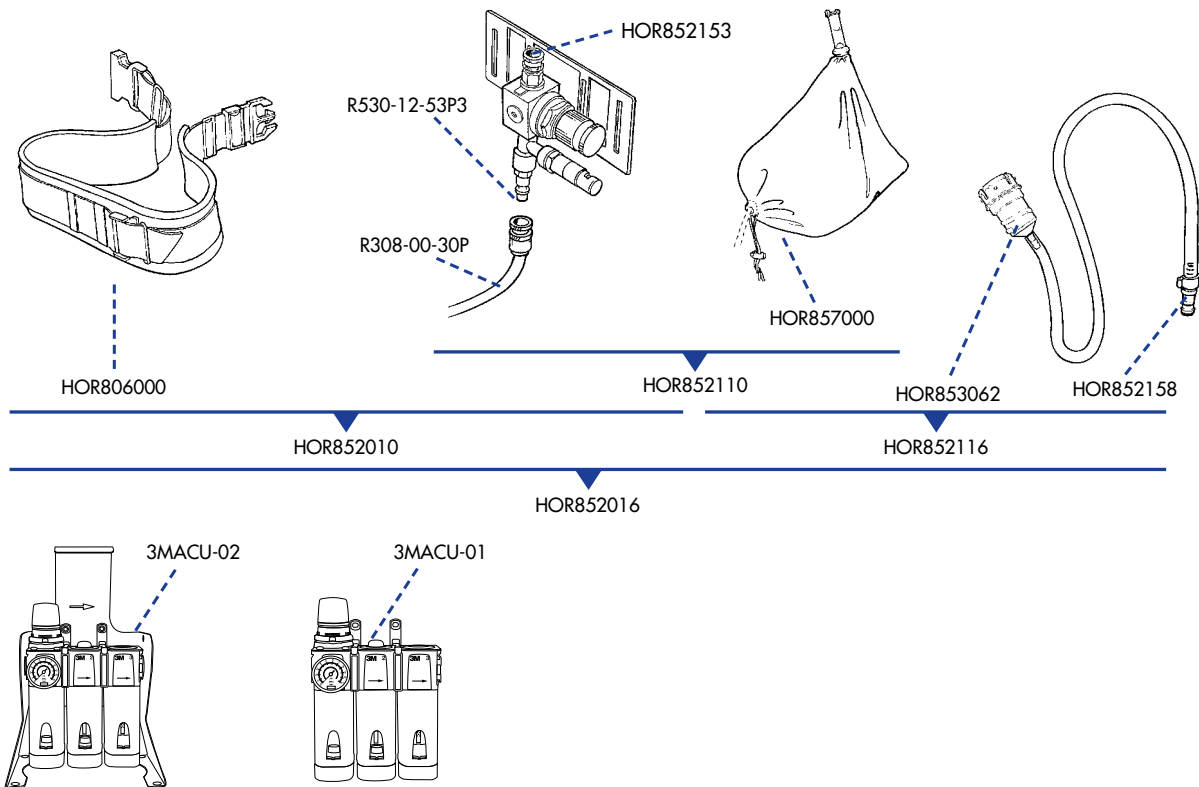

Code	Description
HOR806000	Comfort belt
HOR852010	Variable air flow regulator, low pressure alarm, comfort belt and storage bag
HOR852016	Fresh-air C system with variable air flow regulator, low pressure alarm, air hose, comfort belt and storage bag

Code	Description
HOR852158	Nipple air hose CEJN 220 1/4"
HOR853062	Breathing tube
R308-00-30P	Approved air hose 10m. Other lengths according to quotation
HOR857000	Storage bag
3MACU-01	Aircare Filtration Unit - Wall Unit
3MACU-02	Aircare Filtration Unit - Floor unit

Code	Description
HOR852110	Fresh-air C system with variable air flow regulator with low pressure alarm and storage bag
HOR852116	Fresh-air C system with variable air flow regulator with low pressure alarm, air hose and storage bag
HOR852153	Quick connection CEJN 220 1/4"
R530-12-53P3	Nipple regulator CEJN 342

### 9002 Welding Helmets

for Respiratory Protection

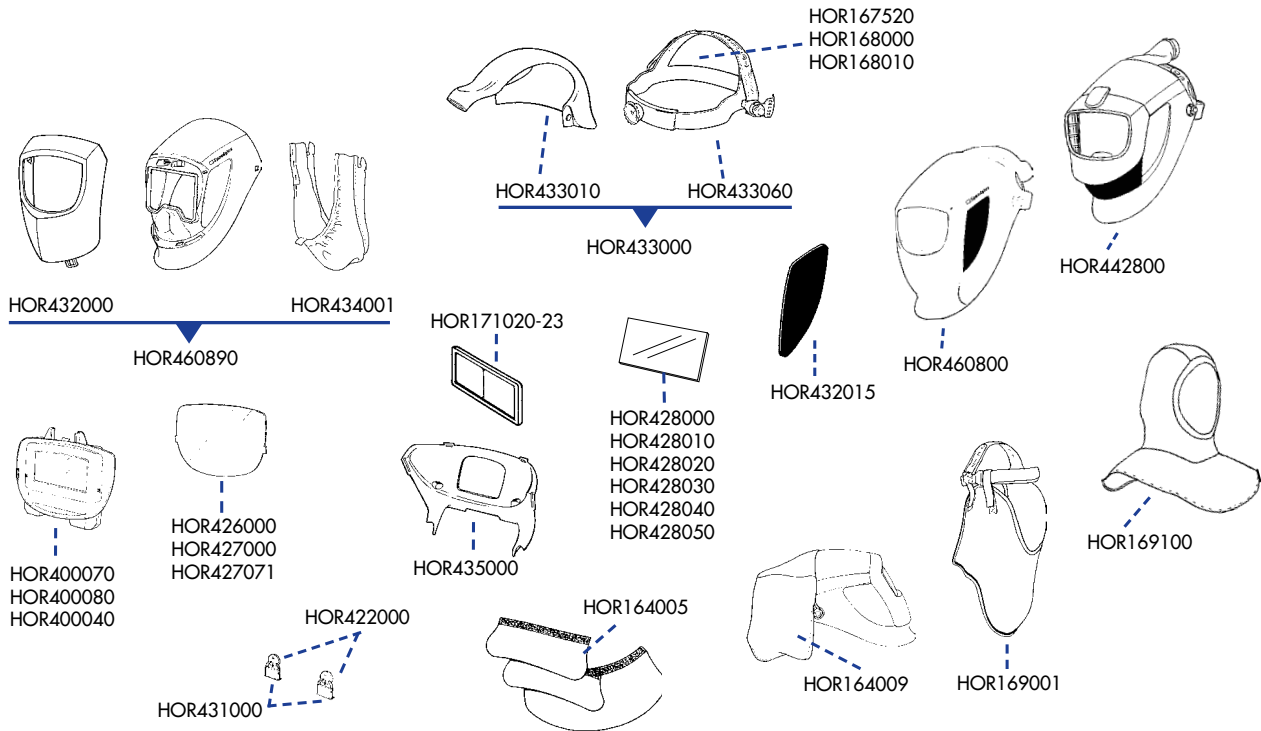

Code	Description	Code	Description	Code	Description
HOR164005	Ear and throat protection in leather (3 parts)	HOR427000	Outer protection plate scratch resistant plate marking 420100 (pack of 10)	HOR431000	Battery cover (pack of 2)
HOR164009	Head cover, TecaWeld, big	HOR427071	Outer protection plate heat resistant plate marking 420170 (pack of 10)	HOR432000	Heat reflecting silver front
HOR167520	Sweatband towelling (2 pcs)	HOR428000	9000F/9002V Inner protection plate (42x91mm) plate marking 420200 (pack of 5)	HOR432015	SideWindows cover plate (5 pairs)
HOR168000	Sweatband in leather	HOR428010	9002X/9000XF Inner protection plate (53x103mm) plate marking 420210 (pack of 5)	HOR433000	Headband with air duct
HOR168010	Sweatband fleece	HOR428020	9000F/9002V Inner protection plate +1 Shade number (pack of 5)	HOR433010	Air duct
HOR169001	Throat cover, TecaWeld	HOR428030	9002X/9000XF Inner protection plate +1 Shade number (pack of 5)	HOR433060	Headband without air duct
HOR169100	Hood throat/head TecaWeld	HOR428040	9000F/9002V Inner protection plate +2 Shade number (pack of 5)	HOR434001	Face seal
HOR171020	Magnifying lens 1.0	HOR428050	9002X/9000XF Inner protection plate +2 Shade number (pack of 5)	HOR435000	Air spreader
HOR171021	Magnifying lens 1.5			HOR442800	Speedglas FlexView welding helmet for respiratory protection
HOR171022	Magnifying lens 2.0			HOR460800	Speedglas welding helmet for respiratory protection
HOR171023	Magnifying lens 2.5			HOR460890	Speedglas welding helmet with air spreader, face seal and heat reflecting silver front
HOR400070	Speedglas 9002V welding filter, variable shade 9-13				
HOR400080	Speedglas 9002X welding filter, variable shade 9-13				
HOR400040	Speedglas 9002D welding filter, dual shade 9/11				
HOR422000	Battery (pack of 2)				
HOR426000	Outer protection plate standard plate marking 420150 (pack of 10)				



## 10V - The new affordable step onto the 3M Welding Technology Ladder

The 3M™ 10V Welding Helmet represents a quality welding helmet at an entry level from a trusted market leader in Welding safety.



Arriving  
Q1 2013

- Robust industrial design
- Shades 10,11 or 12
- Sensitivity settings
- Protection against high speed particles: class F (EN175)
- Light weight, only 370 gram
- Designed to fit with safety spectacles and disposable respirators

**3M Speedglas ▶▶**  
3M Speedglas End of Line Products



 **Speedglas™**

**3M**

Call us on 01925 666198

145

# ▶▶ 3M Speedglas 9002D Welding Helmet



With a dual shade auto-darkening filter and two sensitivity levels, the 3M™ Speedglas™ 9002D offers the welder an excellent choice of settings. This helmet features SideWindows and CO<sub>2</sub> reduction vents for improved comfort.

## Features and Benefits:

- Complete helmet with 9002D welding filter, shade 9/11 (dual)
- SideWindows
- Exhaust vents
- Light state shade 3
- Switching time light-dark 0.4ms (+23°C)



**3M™ Speedglas™ 9002D Welding Helmet**

Classification 1/2/2  
Conforms to EN 379, EN 175 level F

## 3M™ Speedglas™ 9002 Common Consumables

- |           |  |
|-----------|--|
| HOR426000 | outer protection plate standard (pack 10)          |
| HOR427000 | outer protection plate scratch resistant (pack 10) |
| HOR169001 | Throat cover, Teca Weld                            |

## All helmets work well with 3M Hearing Protection

3M™ 1310 Cap Banded Ear Plugs



3M™ E-A-R™ Ultrafit™ Corded Ear Plugs



3M™ E-A-R™ Push-Ins™ Ear Plugs







## 9002D Welding Helmet (complete with auto-darkening filter)

9000 Helmet with 9002D filter shade 9 and 11

With SideWindows  
Code

Without SideWindows  
Code

HOR401840

HOR401140

## 9000 Helmet without auto-darkening filter

HOR401800

HOR401100

## 9002D Auto-Darkening Filter (ADF)

9002D filter shade 9 and 11

HOR400040

For spares and accessories, see page 149.

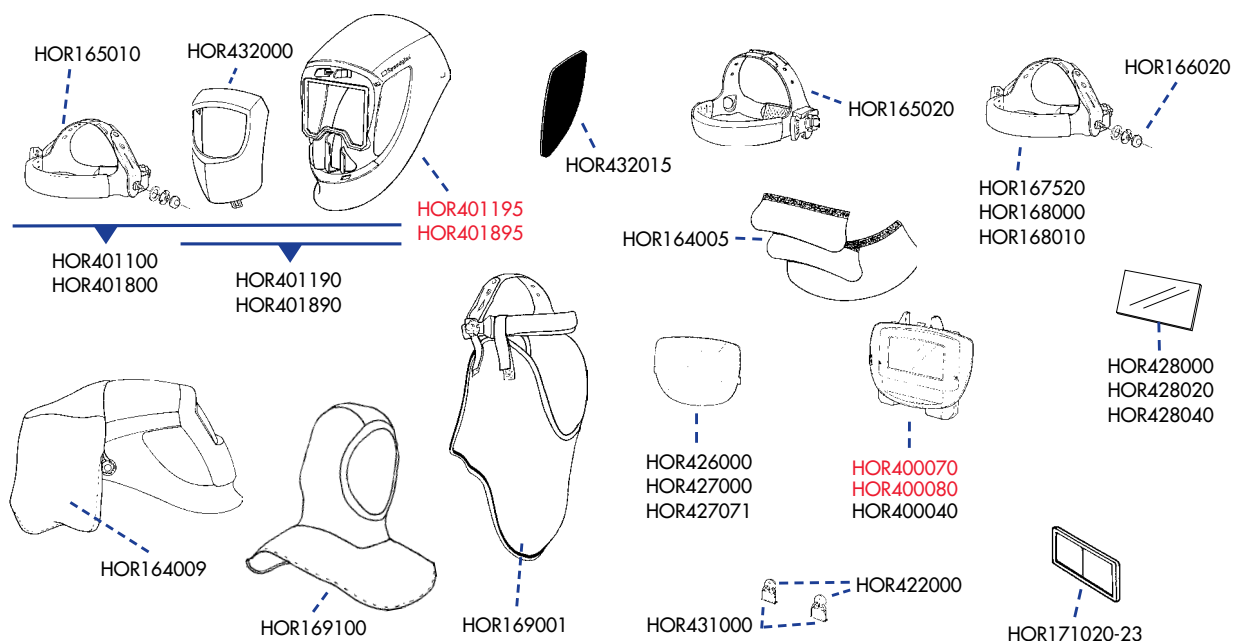

Items shown in red are no longer available but remain for reference.

# ▶▶ 3M Speedglas 9000 FlexView Welding Helmet



## 9000 FlexView Helmet without Auto-Darkening Filter\*

\*Combine with choice of Auto-Darkening Filters from:

### 9002 Auto-Darkening Filters (ADFs)

9002D filter shade 9 and 11

9002V filter - shade 9-13

9002X filter - shade 9-13

### Additional spares for FlexView Helmet

Welding filter holder

Protection plate 120x90mm (pack of 10)

Speedglas FlexView conversion kit

Middle helmet shell, Black

Outer welding hood, Silver

Conventional glass lens holder - shade 11

For further spares see page 149.

With SideWindows  
Code

Without SideWindows  
Code

HOR441800

HOR441100

HOR400040

**HOR400070**

**HOR400080**

HOR197140

HOR423000

HOR440500

HOR441000

HOR442000

HOR443000

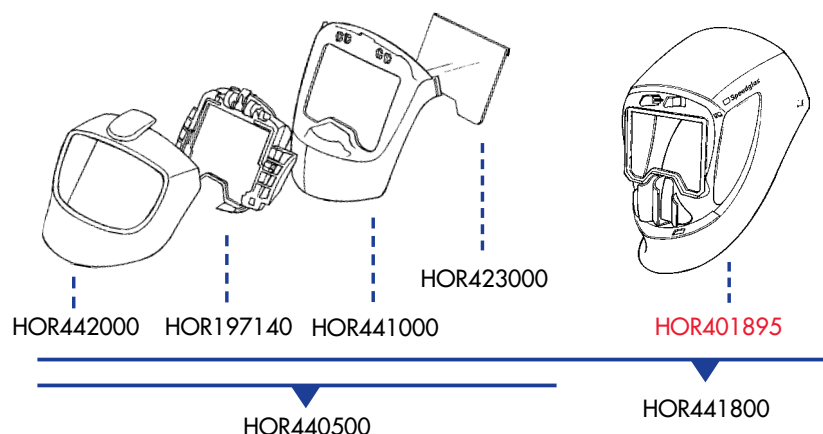

Items shown in red are no longer available but remain for reference.

### Outer Protection Plates

Outer protection plate standard marked 420150 (pack of 10)

Outer protection plate scratch resistant marked 420100 (pack of 10)

Outer protection plate heat resistant (pack of 10)

### Inner Protection Plates

9002D/9002V Inner protection plate (42x91mm) marked 420200 (pack of 5)

9002D/9002V Inner protection plate +1 shade number (pack of 5)

9002D/9002V Inner protection plate +2 shade number (pack of 5)

### Head, Ear and Throat Protection

Ear and throat protection in leather (3 parts)

Head cover, Teca Weld, big

Throat cover, Teca Weld

Hood throat/head Teca Weld

### Magnifying Lenses

Magnifying Lens 1.0

Magnifying Lens 1.5

Magnifying Lens 2.0

Magnifying Lens 2.5

### Sweatbands

Sweatband towelling (2 pcs)

Sweatband in leather

Sweatband fleece

### Batteries

Battery (pack of 2)

Battery cover (pack of 2)

### Other Items

Headband with mounting details standard

Headband 1 UL with mounting details

Mounting details for headband

Welding hood (excl. headband)

Welding hood (excl. headband) with SideWindows

Outer welding hood

SideWindows cover plate 5 pairs

Speedglas tube bag

Speedglas welding caps

Code

HOR426000

HOR427000

HOR427071

HOR428000

HOR428020

HOR428040

HOR164005

HOR164009

HOR169001

HOR169100

HOR171020

HOR171021

HOR171022

HOR171023

HOR167520

HOR168000

HOR168010

HOR422000

HOR431000

HOR165010

HOR165020

HOR166020

HOR401190

HOR401890

HOR432000

HOR432015

HOR940419

HOR954410

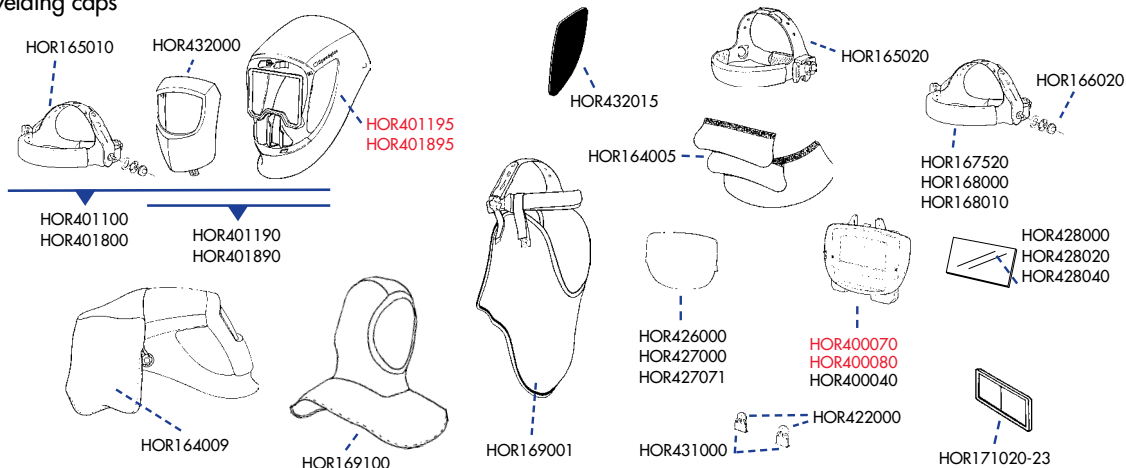

Items shown in red are no longer available but remain for reference.

# ▶▶ 3M Speedglas 9000 Series Air Helmets for Respiratory Protection

## 9000 Air Helmets (without Auto-Darkening Filter)

- 9000 welding helmet for respiratory protection (with SideWindows)
- 9000 welding helmet for respiratory protection (without SideWindows)
- 9000 FlexView welding helmet for respiratory protection (with SideWindows)
- 9000 FlexView welding helmet for respiratory protection (without SideWindows)
- 9000 Helmet with safety hard hat (with SideWindows)
- 9000 FlexView Helmet with safety hard hat (with SideWindows)

## 9000 Adflo Systems with Auto-Darkening Filter

- FlexView shade 11 helmet with Adflo Powered Air Respirator (passive lens)
- Flexview 9002X shade 9-13 air helmet with safety hard hat and Adflo Powered Air Respirator
- FlexView 9002V shade 9-13 air helmet with safety hard hat and Adflo Powered Air Respirator

## 9000 Adflo Systems without Auto-Darkening Filter

- FlexView 9000 air helmet with Adflo Powered Air Respirator
- 9000 air helmet with Adflo Powered Air Respirator

## Auto-Darkening Filters (ADFs)

- 9002D filter shade 9 and 11
- 9002V filter shade 9-13
- 9002X filter shade 9-13

## Other Spares for 9000 air helmets

- Face seal
- Headband with air duct
- Air duct
- Headband without air duct
- Air spreader
- Speedglas welding hood with air spreader, face seal and outer welding hood
- Helmet seal in leather for Speedglas with Peltor safety helmet
- Speedglas 9000 visor for safety helmet with face seal and mounting details
- Safety helmet with air duct
- Fastening details for face seal

## Air Hoses

- Air hose, standard
- Air hose cover
- Air hose, rubber

Code  
HOR460800  
HOR460100  
HOR442800  
HOR442100  
HOR471800  
HOR444800

HOR443800  
HOR446880  
HOR446870

HOR446800  
HOR476600

HOR400040  
HOR400070  
HOR400080

HOR434001  
HOR433000  
HOR433010  
HOR433060  
HOR435000  
HOR460890  
HOR434011  
HOR471800  
HOR896050  
HOR896072

HOR834000  
HOR834003  
HOR834005

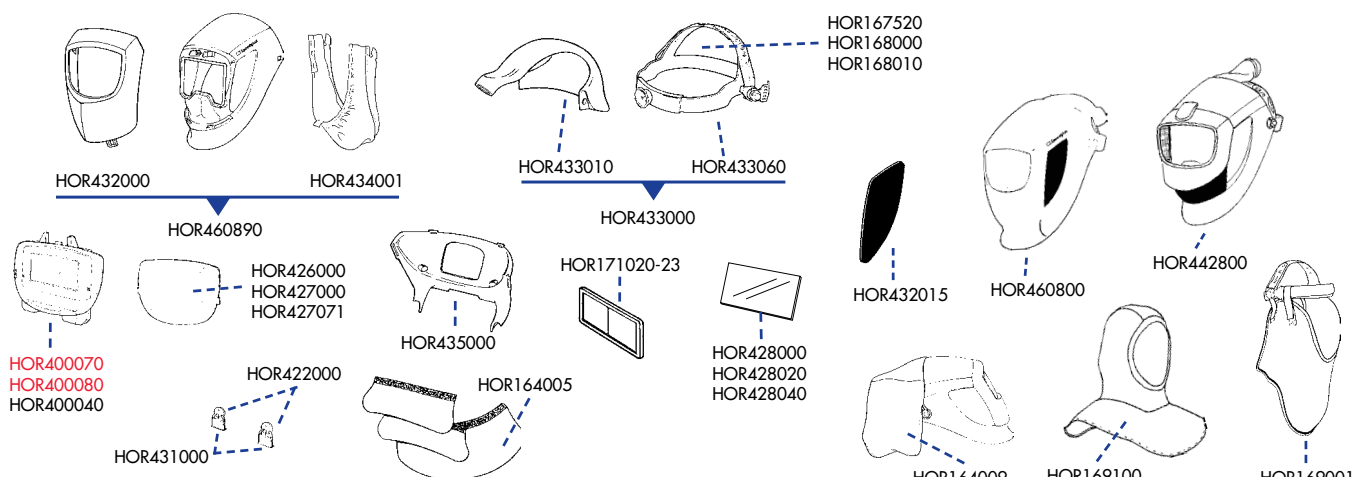

Items shown in red are no longer available but remain for reference.



# Safety & PPE ▲

Welding Curtains, Frames & Accessories	152-153
Welding/Grinding & Fire Blankets	154-155
Futuris FF Auto-Darkening Welding Helmets	156-157
Optrel Auto-Darkening Welding Helmets & Spares	158-159
Passive Welding Helmets & Lenses	160-167
Powered & Supplied Air Systems	168-174
Respirators - Disposable & Reusable	175-177
Respirators - Reusable	178-179
Mechanical Hand Protection - General Purpose	180-181
Mechanical Hand Protection - Cut Protection	182
Special Purpose Hand Protection - Heat/Welding	183-186
Special Purpose Hand Protection - Cold	187
Special Purpose Hand Protection - Chemical Resistance	188
Hand Protection Standards	189
Ear Protection - Disposable & Reusable Earplugs	190-192
Ear Protection - Ear Defenders	193-197
Eye Protection - Spectacles	198-203
Eye Protection - Goggles	204-207
Eye Protection - Faceshields	208
Eye Protection - Care & Maintenance	209
Protective Clothing	214-220
Other Safety Equipment	221
Disposable Protective Clothing	222-223
Buff® Professional	224-230

# ► Safety & PPE

## Welding Curtains, Frames & Accessories

### Complete Welding Curtain Kits

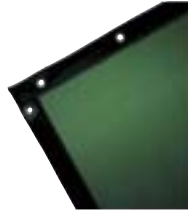

FUTURIS

EN1598



- Complete frame kit with EN1598 Green Curtain
- Kit contains:
  - Powder Coated Extending frame
  - Rings
  - EN1598 Green curtain
- Available in 6'x4', 6'x6' & 6'x8'

Code	Description	Pack
FUTKIT-6X4-GRN	Green 6' x 4' - 1.83m x 1.22m	1
FUTKIT-6X6-GRN	Green 6' x 6' - 1.83m x 1.83m	1
FUTKIT-6X8-GRN	Green 6' x 8' - 1.83m x 2.44m	1

Code	Description	Pack
FUTKIT-6X4-ORN	Orange 6' x 4' - 1.83m x 1.22m	1
FUTKIT-6X6-ORN	Orange 6' x 6' - 1.83m x 1.83m	1
FUTKIT-6X8-ORN	Orange 6' x 8' - 1.83m x 2.44m	1

### Welding Curtain Frames



FUTURIS

- Frames supplied in an easy to assemble kit form
- High tensile steel tube frames with a powder coated finish
- Optional castor kit

#### Frame Sizes

- 6' x 4' - 1.83 x 1.22m
- 6' x 6' - 1.83 x 1.83m
- (including extension bars to make 6' x 8' - 1.83m x 2.44m frame)

Code	Description	Pack
060315	Frame 6' x 4' - 1.83m x 1.22m	1
FUT060300	Frame 6' x 6' - 1.83m x 1.83m	1

### Welding Curtain Frames - Heavy Duty



FUTURIS

Ideal for the hire industry as the rugged construction allows for repeated assembly and disassembly

- Heavy duty square section curtain frame
- Easily clips and bolts together
- Powder coated finish
- Optional castor kit
- 6' x 6' - 1.83 X 1.83m with optional extension bars to make 6'x8' - 1.83m X 2.44m

Code	Description	Pack
FUTHDFRAME	Heavy Duty Frame 6' x 6'	1
FUTHDFRAMEEXTEN	HD Frame extension to 6'x8'	1
FUTDCASTORS	HD Braked Castors Kit	1

### Welding Curtains - Canvas



**FUTURIS**™

- Superior quality opaque canvas curtain from Futuris
- Protection against the effects of welding flash, sparks and cutting and grinding work areas
- Ideal for creating segregated welding areas/ booths
- Flame Retardant dipped
- Frame & curtain rings must be purchased seperately

Code	Description	Pack
060250	FR 6" X 6" - 1.83m X 1.83m	1
060270	FR 6" X 8" - 1.83m X 2.44m	1

### Welding Curtains - PVC



**FUTURIS**™

EN1598



- Protection against dangerous radiations and projectiles emitted by welding arcs
- Ideal for creating segregated welding areas/ booths
- Complies with EN1598 to safely block out welding light
- Semi transparent with eyelets down all sides
- Folded seams on all sides for extra strength

Code	Description	Pack
FUTCUR-6X4-GRN	Green 6" X 4" - 1.83m X 1.22m	1
FUTCUR-6X6-GRN	Green 6" X 6" - 1.83m X 1.83m	1
FUTCUR-6X8-GRN	Green 6" X 8" - 1.83m X 2.44m	1



Code	Description	Pack
FUTCUR-6X4-ORN	Orange 6" X 4" - 1.83m X 1.22m	1
FUTCUR-6X6-ORN	Orange 6" X 6" - 1.83m X 1.83m	1
FUTCUR-6X8-ORN	Orange 6" X 8" - 1.83m X 2.44m	1

### Welding Curtain Accessories



**FUTURIS**™

- Nickel plated curtain rings for use with PVC or canvas welding curtains
- Castors Kit - includes 4 wheels for futuris frames
- Curtain Strips - Bronze - 300X2mm

Code	Description	Pack
FUT060280	Curtain Rings	10
FUTCASTORS	Castors Kit	1
FUT060350	Bronze Curtain Strip	1

# ►► Safety & PPE

## Welding & Grinding Blankets

### How to choose your Blanket

LIGHT DUTY	MEDIUM DUTY	HEAVY DUTY
Protection from sparks & minimal spatter	Protection from sparks & heavy spatter	Protection from molten slag generated by metal cutting applications
<ul style="list-style-type: none"> <li>The non-coated fibreglass materials provide an efficient shield when draped over equipment or flooring surfaces</li> <li>The coated fibreglass materials provide an excellent vertical screen to protect equipment &amp; personnel from the spray of sparks</li> </ul>	<ul style="list-style-type: none"> <li>Give protection from sparks, spatter &amp; minimal slag generated from a fabrication activity</li> <li>Specially coated fabric will be a long lasting welding aid</li> </ul>	<ul style="list-style-type: none"> <li>Soft &amp; flexible fabric resulting from a unique leaching process to remove impurities. Maintains the highest temperature rating in its class</li> <li>Best choice when heavy molten metal slag generation is a problem</li> </ul>
<b>FUTBL-LD</b>	<b>FUTBL-MD</b>	<b>FUTBL-HD</b> <b>FUTBL-XHD</b>

### Light Duty Blanket



550° Max

- Light use - uncoated fibreglass
- Provides thermal protection from welding sparks & spatter
- Ideal for pipe wrapping, stress relieving cover & insulation
- Not recommended for molten metal slag protection
- Working temperature 400°C - Weight 600g



Code	Description	Pack
FUTBL-LD-2X1	Light Duty 2m X 1m	1
FUTBL-LD-2X2	Light Duty 2m X 2m	1
FUTBL-LD-3X2	Light Duty 3m X 2m	1
FUTBL-LD-1X25	Light Duty 1m X 25m Roll	1

### Medium Duty Blanket



750° Max

- Medium duty - vermiculite coated fibreglass
- Provides good spark & spatter protection in medium welding applications
- Also suitable for heat treating
- Working temperature 540°C - Weight 750g



Code	Description	Pack
FUTBL-MD-2X1	Medium Duty 2m X 1m	1
FUTBL-MD-2X2	Medium Duty 2m X 2m	1
FUTBL-MD-3X2	Medium Duty 3m X 2m	1
FUTBL-MD-1X25	Medium Duty 1m X 25m	1



### Heavy Duty Blanket



1300° Max

- Provides heavy duty thermal protection in extreme conditions, where protection from metal slag is required
- Excellent material - uncoated silica for thermal & electrical insulation with a superior chemical resistance
- Will withstand molten metal on a horizontal plane
- Working temperature 930°C - Weight 600g



Code	Description	Pack
FUTBL-HD-2X1	Heavy Duty 2m X 1m	1
FUTBL-HD-2X2	Heavy Duty 2m X 2m	1
FUTBL-HD-3X2	Heavy Duty 3m X 2m	1
FUTBL-HD-1X25	Heavy Duty 1m X 25m Roll	1

### Extra Heavy Duty Blanket



1300° Max

- Provides heavy duty thermal protection in extreme conditions, where protection from metal slag is required
- Excellent material - uncoated silica for thermal & electrical insulation with a superior chemical resistance
- Will withstand molten metal on a horizontal plane
- Working temperature 930°C - 1200g



Code	Description	Pack
FUTBL-XHD-2X1	X Heavy Duty 2m X 1m	1
FUTBL-XHD-2X2	X Heavy Duty 2m X 2m	1
FUTBL-XHD-3X2	X Heavy Duty 3m X 2m	1
FUTBL-XHD-1X25	X Heavy Duty 1m X 25m Roll	1

### Fire Blanket



EN1869



- A quality wall mountable fire blanket manufactured to BS EN1869
- Available in various sizes
- Unique 2 layers of woven glass-fibre fabric
- From the market leader of BSI kite-marked fire blankets

Code	Description	Pack
FIRBL-1.2X1.2	1.2m X 1.2m	1
FIRBL-1.8X1.2	1.8m X 1.2m	1

### Welding Cushion



- Comfortable leather and aluminium heat resistant welding cushion
- Protects the user from heat transfer and hard surfaces
- 600°C aluminium coated welding blanket material on reverse



Code	Description	Pack
FUT-WELD-CUSH	Cushion 0.5m x 0.5m	1

# ►► Safety & PPE

## Futuris FF Auto-Darkening Welding Helmets

### Futuris FF-X350 Auto-Darkening Welding Helmet

Fully certified solar powered welding helmet with automatic shading



- Automatic darkening shade cartridge DIN 9-13
- True Colour filter
- 3 sensors: 2 which detect the welding arc & 1 detecting the intensity of the arc
- Viewing area: 98x44mm
- 1 year warranty



EN379

EN175



*Shaped to allow spatter to roll off  
Cutaway shape to prevent contact  
with shoulder and chest area*



Code	Description	Pack
FUTFF-X350	FF-X350 Helmet Shades 9-13	1
FUTFF-X350-RS	FF-X350 Graphics Helmet	1
FUTFF-X350-IN	FF-X350 Inner Cover Lens	10
FUTFF-X350-OUT	FF-X350 Outer Cover Lens	10

### Futuris FF-X800 Auto-Darkening Welding & Grinding Helmet

Fully certified solar powered welding helmet with automatic shading



**FUTURIS**™

- Light shade: DIN 3.5
- Dark shade: Variable shade 6-9 / 9-13
- UV/IR protection up to DIN 16
- Switching time 1/25000s from light to dark
- Arc sensor: 4
- Grinding facility
- Solar powered and adjustable sensitivity
- Viewing area: 98x62mm
- 1 year warranty

Code	Description	Pack
FUTFF-X800	FF-X800 Helmet Shades 9-13	1
FUTFF-X800-IN	FF-X800 Inner Cover Lens	10
FUTFF-X800-OUT	FF-X800 Outer Cover Lens	10



**FF**<sup>x</sup>**800**

# ▶▶ Safety & PPE

## Optrel Auto-Darkening Welding Helmets

### Optrel e650 Helmet



- Welding helmet with automatic shade cartridge
- Variable shade level from 9 to 13 with a large viewing area (50x100mm)
- Sensitivity, delay, grind & sensor slide which enables the welder to adapt the cartridge to his personal needs
- Adjustable sensitivity - off-delay switch

Code	Description	Pack
OPT1006300	e650 Shade 4/9-13 - Black	1
OPT1006310	e650 Shade 4/9-13 - Ruby	1



*For all welding processes & grinding (not suitable for gas or laser welding)*

### Optrel e670 Helmet



- Welding helmet with a unique automatic shade level detection mode
- Automatic shade cartridge DIN 9-13
- True Colour filter
- 3 sensors: 2 which detect the welding arc & 1 detecting the intensity of the arc
- Adjustable sensitivity - off-delay switch

Code	Description	Pack
OPT1006200	e670 Shade 4/9-13 - Black	1



*For all welding processes & grinding (not suitable for gas nor laser welding)*

### Optrel e680 Helmet



- Welding helmet with 2 automatic shade levels: DIN 5-9 or DIN 9-13
- Large viewing area (50x100mm)
- True Colour filter
- Adjustable sensitivity - off-delay switch

Code	Description	Pack
OPT1006110	e680 Shade 4/9-13 Dark Blue	1



*For all welding processes & grinding (not suitable for laser welding)*

### Optrel eSeries Lenses



- Outside cover lens for e650, e670 & e680 Helmets
- Inside cover lens for e650, e670 & e680 Helmets

Code	Description	Pack
OPT5000212	Outside Cover Lens	5
OPT5000001	Inside Cover Lens	5



### Optrel Legacy Parts & Accessories



- Optrel Outside Cover lens for OSC, TWI, MIRA
- Optrel Headband for OSE, OSC, Twisty and Mira+
- Filter TH3P R SL for E1100 TH2P system (not shown)
- Face Seal Supplied Air OS100 - suitable for e600 helmets

Code	Description	Pack
OPT5000105	Outside Cover Lens	10
OPT5003250	Headband	1
OPT4088000	Filter TH3P	1
OPT4160000	Face Seal	1



# ►► Safety & PPE

## Passive Welding Helmets

### Futuris Headscreen Lightweight 4<sup>1</sup>/<sub>4</sub> x 3<sup>1</sup>/<sub>4</sub>"



FUTURIS

- Lightweight head screen from the quality Futuris range
- 4<sup>1</sup>/<sub>4</sub> x 3<sup>1</sup>/<sub>4</sub>" lens
- EN175

Code	Description	Pack
060208	Lightweight 4 <sup>1</sup> / <sub>4</sub> x 3 <sup>1</sup> / <sub>4</sub> "	1

### Futuris Headscreen Lightweight Flip-Up 4<sup>1</sup>/<sub>4</sub> x 2"



FUTURIS

- Lightweight head screen from the popular Futuris range
- 4<sup>1</sup>/<sub>4</sub> x 2" lens
- EN175

Code	Description	Pack
060213	Lightweight 4 <sup>1</sup> / <sub>4</sub> x 2"	1

### Futuris Handscreen 4<sup>1</sup>/<sub>4</sub> x 3<sup>1</sup>/<sub>4</sub>"



FUTURIS

- Hand screen from the quality Futuris range
- 4<sup>1</sup>/<sub>4</sub> x 3<sup>1</sup>/<sub>4</sub>" lens
- EN175

Code	Description	Pack
060226	Handscreen 4 <sup>1</sup> / <sub>4</sub> x 3 <sup>1</sup> / <sub>4</sub> "	1

### Futuris Flip-Up Headscreen for Hard Hat



FUTURIS

- Lightweight flip-up headscreen for use with safety hard hat
- Hard hat not included
- 4<sup>1</sup>/<sub>4</sub> x 2" lens
- EN175F

Code	Description	Pack
FUTWELDSHIELD	Flip-up Headscreen for Hard Hat	1

### Futuris Fibreglass Headshield 4<sup>1</sup>/<sub>4</sub> x 3<sup>1</sup>/<sub>4</sub>"



- Industry standard fibreglass headshield for the welding professional
- 4<sup>1</sup>/<sub>4</sub> x 3<sup>1</sup>/<sub>4</sub>" lens
- Conforms to EN166, EN169 & EN175

Code	Description	Pack
FUTHEADSHIELD	Fibreglass Headshield	1

### Futuris Fibreglass Headshield 4<sup>1</sup>/<sub>4</sub> x 2" Flip - Up



- Lightweight compound fibreglass headshield
- 4<sup>1</sup>/<sub>4</sub> x 2" Flip-Up lens
- Conforms to EN166, EN169 & EN175

Code	Description	Pack
FUTHEADSHIELDLU	Fibreglass Headshield Flip-Up	1

### Futuris Fibreglass Headscreen 4<sup>1</sup>/<sub>4</sub> x 3<sup>1</sup>/<sub>4</sub>"



- Fibreglass headscreen from the quality Futuris range
- 4<sup>1</sup>/<sub>4</sub> x 3<sup>1</sup>/<sub>4</sub>" lens
- EN175

Code	Description	Pack
FUTHEADSHIELDLS	Fibreglass Headshield 4 <sup>1</sup> / <sub>4</sub> x 3 <sup>1</sup> / <sub>4</sub> "	1

### Futuris Fibreglass Handscreen 4<sup>1</sup>/<sub>4</sub> x 3<sup>1</sup>/<sub>4</sub>"



- Handscreen from the quality Futuris range
- 4<sup>1</sup>/<sub>4</sub> x 3<sup>1</sup>/<sub>4</sub>" lens
- EN175
- Fibre Glass
- Cutaway to aid holding

Code	Description	Pack
FUTHANDSCREEN	Handscreen 4 <sup>1</sup> / <sub>4</sub> x 3 <sup>1</sup> / <sub>4</sub> " Fibreglass	1

### Stephens-Itex 799 Headshield 4<sup>1/4</sup> x 3<sup>1/4</sup>"



- Industry standard fibreglass headshield for the welding professional
- 4<sup>1/4</sup> x 3<sup>1/4</sup>" lens
- Conforms to EN166, EN169 & EN175

Code	Description	Pack
060401	799 Headshield	1

### Stephens-Itex Minor Headshield 4<sup>1/4</sup> x 3<sup>1/4</sup>"



- Lightweight compound fibreglass headshield
- 4<sup>1/4</sup> x 3<sup>1/4</sup>" lens
- Conforms to EN166, EN169 & EN175

Code	Description	Pack
060402	Minor Headshield	1

### Stephens-Itex Minor Headshield Flip-Up 4<sup>1/4</sup> x 2"



- Lightweight compound fibreglass flip-up headshield for the welding professional
- 4<sup>1/4</sup> x 2" lens
- Conforms to EN166, EN169 & EN175

Code	Description	Pack
060403	Minor Flip-Up Headshield	1

### Stephens-Itex Headshield Flip-Up 4<sup>1/4</sup> x 3<sup>1/4</sup>"



- Industry standard fibreglass flip-up headshield for the welding professional
- 4<sup>1/4</sup> x 3<sup>1/4</sup>" lens
- Conforms to EN166, EN169 & EN175

Code	Description	Pack
060409	Flip-Up Headshield	1



### Stephens-Itex 802 Handshield



- Industry standard fibreglass handshield
- 4 1/4 x 3 1/4" lens
- Conforms to EN166, EN169 & EN175

Code	Description	Pack
060227	802 Handshield	1

### North Prota Shell Baby Headshield Fixed 4 1/4 x 3 1/4"



- Lightweight welding helmet for all welding applications including applications above the head
- Unique straight shell, impact resistant & durable
- Ratchet adjustment type suspension
- 4 1/4 x 3 1/4" lens
- Conforms to EN175

Code	Description	Pack
FOC810320	Baby Fixed Headshield	1

### North Prota Shell Baby Headshield Flip-Up 4 1/4 x 2"



- Lightweight flip-up welding helmet for all welding applications including applications above the head
- Unique straight shell, impact resistant & durable
- Ratchet adjustment type suspension
- 4 1/4 x 2" lens
- Conforms to EN175

Code	Description	Pack
FOC810300	Baby Flip-Up Headshield	1

### North Prota Shell Headshield Flip-Up 4 1/4 x 2"



- Flip-up welding helmet for all welding applications including applications above the head
- Unique straight shell, impact resistant & durable
- Ratchet adjustment type suspension
- 4 1/4 x 2" lens
- Conforms to EN175

Code	Description	Pack
FOC810900	Flip-Up Headshield	1

# ▶▶ Safety & PPE

## Passive Welding Helmets

### North Gamador Headshield Flip-Up 4 1/4 x 2"



**NORTH**

by Honeywell

- Lightweight welding helmet with Flip-Up lens
- Unique straight shell, impact resistant & durable
- Ratchet adjustment type suspension
- 4 1/4 x 2" lens
- Conforms to EN175

Code	Description	Pack
FOC810400	Gamador Flip-Up Headshield	1

### North Leather Welding (Monkey) Mask - Standard



**NORTH**

by Honeywell

- Leather welding mask for use in restricted access areas
- Standard monkey mask - Length 30cm
- 50mm goggles

Code	Description	Pack
FOC813000	Mask Standard - 30cm	1

### North Leather Welding (Monkey) Mask - Large



**NORTH**

by Honeywell

- Leather welding mask for use in restricted access areas
- Large monkey mask - Length 45cm
- 50mm goggles

Code	Description	Pack
FOC813010	Mask Large - 45cm	1

### Weldas Helmet Comforter



**WELDAS**



EN ISO 11611  
Clause 6.6

- Air cushioned SWEATSO pad
- Combined helmet pad & sweatband in one piece
- Reduces "helmet head" and improves helmet grip with maximum perspiration absorption
- Flame retardant for added safety
- Velcro fastening system to fit all major brands of suspension and non-suspension headgear

Code	Description	Pack
WEL20-3100V	Helmet Comforter	2



**For more info & updates see  
[www.weldspares.co.uk](http://www.weldspares.co.uk)**

# ► Safety & PPE

## Passive Welding Lenses

### Futuris Cover Lens - Clear Glass



Code	Description	Pack
060136	Lens 2"	100
060148	Lens 4 <sup>1/4</sup> x 2"	100
060158	Lens 4 <sup>1/4</sup> x 3 <sup>1/4</sup> "	100
060181	Lens 4 <sup>1/2</sup> x 5 <sup>1/4</sup> "	100
060460	Lens 110 x 60mm	100
060478	Lens 110 x 90mm	100

### Futuris Cover Lens - Anti-Spatter CR39



Code	Description	Pack
060139COV	CR39 Lens 2"	100
060147COV	CR39 Lens 4 <sup>1/4</sup> x 2"	100
060157COV	CR39 Lens 4 <sup>1/4</sup> x 3 <sup>1/4</sup> "	100
060177COV	CR39 Lens 4 <sup>1/2</sup> x 5 <sup>1/4</sup> "	100
060440COV	CR39 Lens 110 x 60mm	100
060476COV	CR39 Lens 110 x 90mm	100

### Futuris Shaded Lens 110 x 60mm / 110 x 90mm



Code	Description	Pack	Code	Description	Pack
060472	110 x 90mm - Shade 9	100	060429	110 x 60mm - Shade 9	100
060473	110 x 90mm - Shade 10	100	060430	110 x 60mm - Shade 10	100
060474	110 x 90mm - Shade 11	100	060431	110 x 60mm - Shade 11	100
060475	110 x 90mm - Shade 12	100	060432	110 x 60mm - Shade 12	100
			060433	110 x 60mm - Shade 13	100

### Futuris Magnifier Lens 4<sup>1/4</sup> x 2"



Code	Description	Pack
FUTMAG-100	Magnifier Lens - Focal Power 1.0	1
FUTMAG-125	Magnifier Lens - Focal Power 1.25	1
FUTMAG-150	Magnifier Lens - Focal Power 1.5	1
FUTMAG-175	Magnifier Lens - Focal Power 1.75	1
FUTMAG-200	Magnifier Lens - Focal Power 2.0	1
FUTMAG-225	Magnifier Lens - Focal Power 2.25	1
FUTMAG-250	Magnifier Lens - Focal Power 2.5	1

Magnifying 4<sup>1/4</sup> x 2" plastic lenses available in various focal powers

### Futuris Shaded Lens 2" Round



- Shaded glass lenses 2" round
- Conforms to EN166:1995 & EN169:1992
- BS679

Code	Description	Pack
060102	2" Round - Shade 10	100
060103	2" Round - Shade 11	100
060104	2" Round - Shade 3	100
060105	2" Round - Shade 4	100
060106	2" Round - Shade 5	100
060107	2" Round - Shade 6	100

### Futuris Shaded Lens 4<sup>1/4</sup> x 3<sup>1/4</sup>"



- Shaded Glass Lens 4<sup>1/4</sup> x 3<sup>1/4</sup>"
- Available in shades 8 -13 and Polycarb
- Conforms to EN166:1995 & EN169:1992

Code	Description	Pack
060150	4 <sup>1/4</sup> x 3 <sup>1/4</sup> " - Polycarb	100
060151	4 <sup>1/4</sup> x 3 <sup>1/4</sup> " - Shade 8	100
060152	4 <sup>1/4</sup> x 3 <sup>1/4</sup> " - Shade 9	100
060153	4 <sup>1/4</sup> x 3 <sup>1/4</sup> " - Shade 10	100
060154	4 <sup>1/4</sup> x 3 <sup>1/4</sup> " - Shade 11	100
060155	4 <sup>1/4</sup> x 3 <sup>1/4</sup> " - Shade 12	100
060156	4 <sup>1/4</sup> x 3 <sup>1/4</sup> " - Shade 13	100

### Futuris Shaded Lens 4<sup>1/4</sup> x 2" (108x50mm)



- Shaded Glass Lens 4<sup>1/4</sup> x 2"
- Available in shades 5,8 -13 and Polycarb
- Conforms to EN166:1995 & EN169:1992

Code	Description	Pack
060132	4 <sup>1/4</sup> x 2" - 108x50mm - Shade 5	100
060138	4 <sup>1/4</sup> x 2" - 108x50mm - Polycarb	100
060141	4 <sup>1/4</sup> x 2" - 108x50mm - Shade 8	100
060142	4 <sup>1/4</sup> x 2" - 108x50mm - Shade 9	100
060143	4 <sup>1/4</sup> x 2" - 108x50mm - Shade 10	100
060144	4 <sup>1/4</sup> x 2" - 108x50mm - Shade 11	100
060145	4 <sup>1/4</sup> x 2" - 108x50mm - Shade 12	100
060146	4 <sup>1/4</sup> x 2" - 108x50mm - Shade 13	100

### Futuris Shaded Lens 4<sup>1/2</sup> x 5<sup>1/4</sup>" (Jackson Style)



- Shaded Glass Lens 4<sup>1/2</sup> x 5<sup>1/4</sup>"
- Available in shades 5,9 -13 and Anti-Spatter CR39
- Conforms to EN166 & EN169
- BS679

Code	Description	Pack
060171	4 <sup>1/2</sup> x5 <sup>1/4</sup> - Shade 5	100
060172	4 <sup>1/2</sup> x5 <sup>1/4</sup> - Shade 9	100
060173	4 <sup>1/2</sup> x5 <sup>1/4</sup> - Shade 10	100
060174	4 <sup>1/2</sup> x5 <sup>1/4</sup> - Shade 11	100
060175	4 <sup>1/2</sup> x5 <sup>1/4</sup> - Shade 12	100
060176	4 <sup>1/2</sup> x5 <sup>1/4</sup> - Shade 13	100
060177COV	4 <sup>1/2</sup> x 5 <sup>1/4</sup> - CR39 Anti Spatter	100

### Honeywell Airvisor 2 MV - Spray Painting Kit

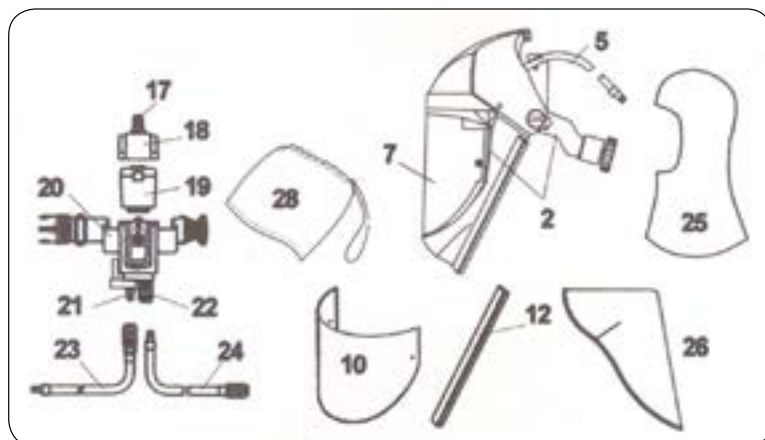

**Honeywell**

• **Complete supplied air spray painting kit (DMAK-0021E) containing:**

- Acetate chemical resistant visor
  - Spraygun air hose with quick release connectors
  - Fabric faceseal cassette
  - 2 disposable visor covers
  - Fabric balaclava
  - Head/neck cover
  - Waistbelt complete (DAVW-1001E) with integral low flow warning device
  - Storage bag
- Disposable visor covers to maintain optimum levels of vision. The anti-static coating minimises the attraction of dust and paint particles from the working environment.
  - Silicone-free, thereby eliminating the risk of damage to the paint finish from poor adhesion and retention
  - Contains an internal carbon filter to remove any odours from the factory airline system and ensure pleasant working conditions
  - Specifically for use where the operator must (or prefers to) use a single air hose to supply both the respirator and the spraygun. In this case the waistbelt unit ensures that the airflow to the visor is consistent, irrespective of the air being drawn off by the triggering of the spraygun, therefore ensuring that sufficient air reaches the user.
  - Suitable for use in automotive & aerospace industries, furniture manufacturing industry and the general chemical industry wherever general painting duties are undertaken
  - Approved to EN14594 Class 4A with an Assigned Protection Factor (APF) of 40 (*must be used with approved Blueline hoses to maintain CE certification*)

Item No.	Code	DeVilbiss® Equivalent	Description	Pack
-	WIL1013938	MPV-623	Airvisor 2 MV DMAK-0021E Spray Painting Kit	1
-	WIL1013981		Replacement headpiece with acetate visor (DMAK-0071E)	1
5	WIL1028825		Replacement air supply tube, diffuser & connector	1
7	WIL1001775	MPV-478-K5	Replacement acetate visor (DTVS-1504/5)	5
7	WIL1001774		Replacement polycarbonate visor (DTVS-1503/5)	1
10	WIL1001778	MPV-44-K10	Spare MV visor covers (DTVS-1507/10)	10
10	WIL1001779	MPV-44-K50	Spare MV visor covers (DTVS-1508/50)	50
12	WIL1013994		Spare fabric faceseal cassette (DTVS-1510/5)	5
25	WIL1001733	MPV-2-K5	Disposable fabric balaclava (DAF-9257/5)	5
26	WIL1001676	MPV-24-K5	Spare fabric head cover (DAVS-1408/5)	5
19	WIL1001672	MPV-22	Carbon cartridge for all waistbelts (DAVS-1404)	1
18	WIL1028829		Regulator for DAVW-1001E & DAVW-1003E waistbelt	1
23	WIL1001726		Blueline Air Supply Hose 3.5m	1
23	WIL1001727		Blueline Air Supply Hose 7.5m	1
23	WIL1004716		Blueline Air Supply Hose 10m	1

DeVilbiss® is a Registered Trademark of ITW Finishing. Reference to OEM part numbers is for ease of use only.

### Honeywell Airvisor 2 MV - Chemical Kit

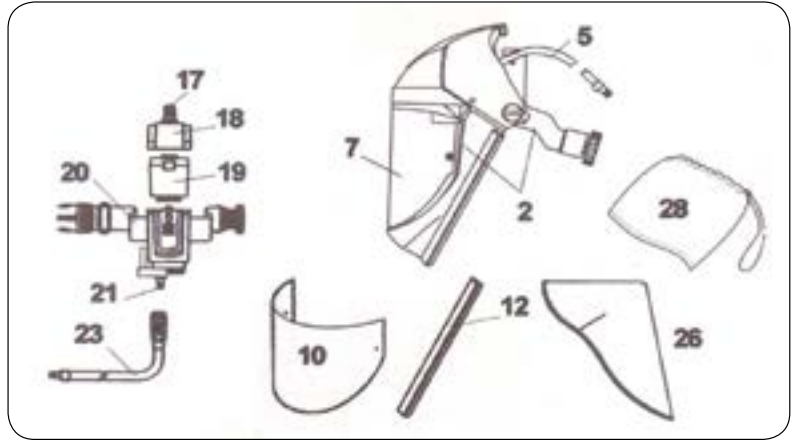

### Honeywell

- **Complete supplied air chemical kit (DMAK-0023E) containing:**

- Acetate chemical resistant visor
  - Fabric facesal cassette
  - 2 disposable visor covers
  - Head/neck cover
  - Waistbelt complete (DAVW-1003E) with integral low flow warning device
  - Storage bag
- Disposable visor covers to maintain optimum levels of vision. The anti-static coating minimises the attraction of dust from the working environment.
  - Silicone-free, thereby eliminating the risk of damage to the paint finish from poor adhesion and retention
  - Contains an internal carbon filter to remove any odours from the factory airline system and ensure pleasant working conditions
  - Specifically for use where the operator must (or prefers to) use separate air hoses to supply the respirator and the auxilliary air tool or spraygun. In this case the waistbelt unit ensures that the airflow to the visor is consistent, irrespective of pressure fluctuations in the factory airline system, therefore ensuring that sufficient air reaches the user.
  - Suitable for use in the chemical industry, handling & production of chemicals and by-products, automotive & aerospace industries where single hose operations are not appropriate, furniture manufacturing industry and the general chemical industry where the respirator is intended for use without any auxilliary air tool or spraygun connected to it.
  - Approved to EN14594 Class 4A with an Assigned Protection Factor (APF) of 40 (*must be used with approved Blueline hoses to maintain CE certification*)

Item No.	Code	DeVilbiss® Equivalent	Description	Pack
-	WIL1013939		Airvisor 2 MV DMAK-0023E Chemical Kit	1
-	WIL1013981		Replacement headpiece with acetate visor (DMAK-0071E)	1
5	WIL1028825		Replacement air supply tube, diffuser & connector	1
7	WIL1001775	MPV-478-K5	Replacement acetate visor (DTVS-1504/5)	5
7	WIL1001774		Replacement polycarbonate visor (DTVS-1503/5)	1
10	WIL100778	MPV-44-K10	Spare MV visor covers (DTVS-1507/10)	10
10	WIL1001779	MPV-44-K50	Spare MV visor covers (DTVS-1508/50)	50
12	WIL1013994		Spare fabric facesal cassette (DTVS-1510/5)	5
26	WIL1001676	MPV-24-K5	Spare fabric head cover (DAVS-1408/5)	5
19	WIL1001672	MPV-22	Carbon cartridge for all waistbelts (DAVS-1404)	1
18	WIL1028829		Regulator for DAVW-1001E & DAVW-1003E waistbelt	1
23	WIL1001726		Blueline Air Supply Hose 3.5m	1
23	WIL1001727		Blueline Air Supply Hose 7.5m	1
23	WIL1004716		Blueline Air Supply Hose 10m	1

DeVilbiss® is a Registered Trademark of ITW Finishing. Reference to OEM part numbers is for ease of use only.

### Honeywell Airvisor 2 - Industrial Kit



**Honeywell**

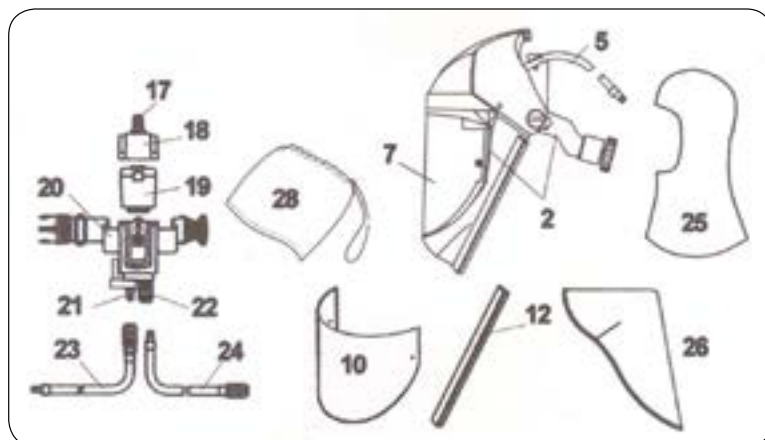

• **Complete supplied air spray painting kit (DAVK-0004E) containing:**

- Polycarbonate impact resistant visor
- Integral foam faced seal
- 2 disposable visor covers
- Head/neck cover
- Waistbelt complete (DAVW-1003E) with integral low flow warning device
- Storage bag

• Disposable visor covers to maintain optimum levels of vision. The anti-static coating minimises the attraction of dust from the working environment.

• Silicone-free, thereby eliminating the risk of damage to the paint finish from poor adhesion and retention

• Contains an internal carbon filter to remove any odours from the factory airline system and ensure pleasant working conditions

• Specifically for use where the operator must (or prefers to) use separate air hoses to supply the respirator and the auxilliary air tool or spraygun. In this case the waistbelt unit ensures that the airflow to the visor is consistent, irrespective of pressure fluctuations in the factory airline system, therefore ensuring that sufficient air reaches the user.

• Suitable for use in industry where single hose operations are not appropriate and/or where the respirator is intended for use without any auxilliary air tool or spraygun connected to it.

• Approved to EN14594 Class 4A with an Assigned Protection Factor (APF) of 40 (*must be used with approved Blueline hoses to maintain CE certification*)

Item No.	Code	DeVilbiss® Equivalent	Description	Pack
-	WIL1013935		Airvisor 2 MV DAVK-0021E Industrial Kit	1
-	WIL1013937		Replacement headpiece with polycarbonate visor (DAVK-0052E)	1
2	WIL1028821		Replacement browguard and frame	1
5	WIL1028825		Airsupply tube, diffuser and connector	1
7	WIL1028827		Polycarbonate visor with foam face skirt	1
10	WIL1001732		Disposable visor cover (DAF-9220/10)	10
10	WIL1001731		Disposable visor cover (DAF-9220/50)	50
25	WIL1001733		Disposable fabric balaclava (DAF-9257/5)	5
26	WIL1001676		Fabric Head Cover (DAVS-1408/5)	5
28	WIL1001738		White Fabric Carrying Bag (DAF-8083)	1
-	WIL1001716		Disposable Chemical Hood (DAF-0705)	1
-	WIL1001799		Comfort pad - Front of Headband (DTVR-CP)	1

DeVilbiss® is a Registered Trademark of ITW Finishing. Reference to OEM part numbers is for ease of use only.



### 3M Versaflo Respiratory Protective Systems

The 3M™ Versaflo™ Respiratory Protective Systems are designed as modular systems where parts can be mixed and matched as needs and preferences change.

For example:

If a user of a 3M™ Versaflo™ TR-300 Turbo and 3M™ Versaflo™ S-533 Hood now requires impact protection for their head, they can simply replace the hood with a helmet.

If a process changes introducing a hazard that cannot be filtered, the system may be converted from powered air to supplied air by replacing the turbo unit with a 3M™ Versaflo™ V-500 Regulator.

This versatility allows users to adapt to changes in hazards, work practices and their personal preference.



#### 3M™ Versaflo™ S-Series Headtops



#### 3M™ Versaflo™ M-Series Headtops



#### 3M™ Welding Headtops

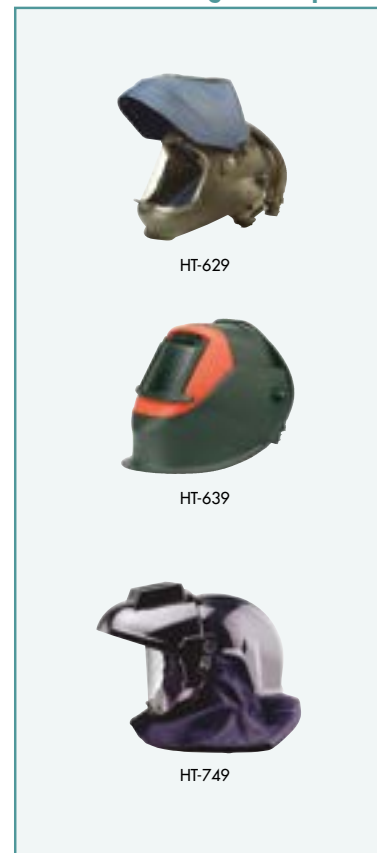

#### 3M™ Breathing tubes

#### Air filtering



#### Non-filtering supplied air



### 3M Versaflo Headtops

The modular range of 3M™ Powered and Supplied Air Respirators lets you choose how you want your respirator built, with the flexibility to change in the future.

The three series of hoods, visors, helmets and welding visors provide a broad selection of headtop designs that are suitable for use in many different industry applications.

#### 3M™ Versaflo™ S-Series Hoods

##### **Lightweight Protection**

A range of head and upper-body coverage hoods, the S-Series includes exceptionally light headcovers and hoods providing class 3 respiratory protection with the Versaflo and Jupiter turbos and modular supplied air belt units.



#### 3M™ 600 Series Welding Visors & Helmets

##### **Welding Applications and Impact Protection**

A range of 3 welding visors designed to increase the levels of welder comfort and productivity.



#### 3M™ Versaflo™ M-100 Series

##### **Faceshields - Respiratory, eye & face protection**

Two options for different applications:  
M-106: general purpose faceseal for dusts, spraying & chemical processing  
M-107: flame resistant faceseal for applications with hot particles



#### 3M™ Versaflo™ M-300 Series

##### **Helmets Respiratory, eye, face & head protection**

Two options for different applications:  
M-306: general purpose faceseal for construction, chemical applications and heavy industries  
M-307: flame resistant faceseal for applications with hot particles



#### 3M™ Versaflo™ M-400 Series

##### **Helmets Respiratory, eye, face & head protection**

Two options for different applications:  
M-406: general purpose shroud for construction, demolition and heavy industries  
M-407: flame resistant shroud for applications with hot particles

### 3M S-757 Premium Maintainable Hood

Combine with the Versaflo TR-300 or the Versaflo V-500E for a complete spray painting kit

Specifically designed to help capture paint overspray, minimising the potential for paint to flake off the wearer and onto the work piece. The fabric also has an internal film barrier to help prevent paint contact with skin or clothes



- Offers head, face, neck and shoulder coverage as well as eye and face protection to EN166
- The head harness and air ducting can be re-used, just replace the soiled hood fabric
- Meets the highest respiratory performance requirements (TH3) when used with the Versaflo TR-300
- Assigned Protection Factor of 40 when used in conjunction with the Versaflo TR-300 or V-500E

Code	Description	Pack
3MS-757	S-757 Hood	1
3MS-707-10	Replacement hood with inner shroud for use with S-757 head suspension	10

- The rigid ducting of the head harness provides a consistent air path
- Features an externally-adjustable airflow control allowing the wearer to modify the airflow distribution in order to suit personal comfort needs



### 3M Jupiter Powered Air Respirator

The Jupiter Powered Air Respirator is comfortable, easy-to-use and provides protection against particulates, gases or vapours, or against a combination of these contaminants depending on the type of filters used.



- Modern, ergonomic design
- Suitable for shower decontamination
- High comfort decontamination belt
- Electronic audible and visual alarm in case of low battery and/or low air flow
- "Intrinsically Safe" (IS) kit available for use in potentially explosive atmospheres
- Approved to EN12941 class TH2 or TH3 dependent on headtop
- Assigned Protection Factor (APF) of 40 with 3M™ Versaflo™ S-Series & M-400 Headtops, APF of 20 with all others

Code	Description	Pack
RTUJUPITER	Jupiter Powered Air Respirator	1

# ▶▶ Safety & PPE

## Powered & Supplied Air Systems

### 3M Versaflo TR-300 Powered Air Respirator

**Combine with the S-757 hood for a complete spray painting kit**

Powered air turbo unit using a battery powered fan and motor to draw contaminated air through a filter. The filter captures certain contaminants and clean air is fed to the wearer

Replaces the Dustmaster



- Extremely slim and lightweight for outstanding comfort
- Highly efficient filter captures hazardous dust, mist and fume <sup>(1)</sup>
- Features an intelligent lithium battery which quickly charges & includes useful charge indicator
- Electronic audible and visual alarm in case of low battery and/or low airflow
- Approved to EN12941 TH3 with an APF<sup>(2)</sup> of 40 when used with the S-757 hood
- Sold as a kit containing:
  - Turbo Unit TR-302E
  - Particulate Filter TR-3710E
  - Pre-filter TR-3600
  - Standard Belt TR-325
  - High Capacity Battery TR-332
  - Battery charger kit (UK) TR-341UK
  - Self-adjusting Breathing Tube BT-30

Code	Description	Pack
3MTR-315UK	Versaflo TR-315UK Powered Air Starter Kit	1

*Also available to buy in separate components*



<sup>(1)</sup> Nuisance level gases & vapours filters available on order

<sup>(2)</sup> Assigned Protection Factor

### 3M Versaflo V-500E Supplied Air Regulator

**Combine with the S-757 hood & the components shown in the table below for a complete spray painting kit**

Supplied air regulator using breathable quality air from a compressor via a tube. The compressed air is regulated to a gentle flow and fed to the wearer



- Offers protection against dust, mist, fume gas vapours and combination hazards
- Ensures smooth airflow, optimum safety and comfort with easy airflow adjustment
- Low-pressure warning whistle
- Replaceable charcoal filter
- Spray gun or compressed air tool port
- Approved to EN14594 3A with an APF\* of 40 when used with the S-757 hood



Code	Product Image	Description	Pack
3MV-500		Versaflo V-500E Supplied Air Regulator	1
R530-12-53P3		Belt Unit Coupling CEJN '342' - plug, 1/4" BSP male	1
R308-00-31P		Standard Duty Hose CAST 30m	1
R530-12-81P3		CAST Hose Unit Coupling CEJN '342' - socket & plug, 3/8" BSP female	1
3MBT-30		Self-Adjusting Breathing Tube	1

### 3M Aura 9300+ Series

#### NEW Embossed and Sculpted Top Panel

- Helps reduce fogging of eyewear and provide a wide field of vision
- Curved, low profile design conforms well to facial contours
- Improves compatibility with eyewear

#### NEW Low Breathing Resistance Filter Technology

- Combines effective filter performance whilst lowering resistance to breathing
- Improves breathing ease and comfort

#### 3M Cool Flow™ Valve

- Effectively removes heat build up resulting in a cooler and more comfortable wear
- Removes exhaled air and minimises the risk of misting eyewear

#### NEW Innovative Chin Tab

- Improves ease of donning and adjustment to help achieve a comfortable fit
- Hygienic individual packaging helps protect from contamination
- Ingenious 3-Panel design fits a wide range of face shapes



**3M**

Code	Description	Pack
3M9310+	Aura™ 9300+ - unvalved - FFP1	10
3M9312+	Aura™ 9300+ - valved - FFP1	10
3M9320+	Aura™ 9300+ - unvalved - FFP2	10
3M9322+	Aura™ 9300+ - valved - FFP2	10
3M9332+	Aura™ 9300+ - valved - FFP3	10

### 3M 8800 Series

#### Robust Shell and Cup Design

- Robust and durable design provides multi-shift capability and a more secure feel

#### 3M™ Cool Flow™ Valve

- Effective removal of heat and moisture build-up provides a cooler and more comfortable wear
- Removes exhaled air and minimises the risk of misting eyewear

#### Adjustable Braided Headbands

- Ensures a more secure feel and provides comfort to face, head and neck

#### Soft Inner Face Seal Ring

- Improves face seal
- Increases wearer comfort
- Can be hygienically cleaned if used for longer than one shift (3M™ 105 Face Seal Cleaner)



**3M**

Code	Description	Pack
3M8825	8800 series - valved - FFP2	10
3M8835S/M	8800 series - valved - FFP3 - S/M	10
3M8835M/L	8800 series - valved - FFP3 - M/L	10

# ▶▶ Safety & PPE

## Respirators - Disposable

### 3M 8000 Series



**3M**

- Traditional convex shape with nose clip and twin strap design
- Reliable, effective protection against fine particles
- Durable, collapse-resistant inner shell

#### 3M™ Cool Flow™ Valve

- Effective removal of heat and moisture build-up provides a cooler and more comfortable wear
- Removes exhaled air and minimises the risk of misting eyewear. Valved and unvalved options

Code	Description	Pack
3M8710E	8000 Series - unvalved - FFP1	20
3M8810	8000 Series - unvalved - FFP2	20
3M8812	8000 Series - valved - FFP1	10
3M8822	8000 Series - valved - FFP2	10

### 3M 9000 Series Speciality



**3M**

#### Robust Shell and Cup Design

- Conforms well to most face shapes and sizes
- Maintains its shape well during use
- Collapse-resistant

#### 3M™ Cool Flow™ Valve

- Effective removal of heat and moisture build-up provides a cooler and more comfortable wear
- Removes exhaled air and minimises the risk of misting eyewear
- Carbon Layer Provides protection against nuisance level organic vapours

Code	Description	Pack
3M9922	9000 Series - valved - FFP2 organic vapour	10

### 3M Welding Respirators



**3M**

- Flame retardant material minimises the effect of welding splatter

#### 3M™ Cool Flow™ Valve

- Effective removal of heat and moisture build-up provides a cooler and more comfortable wear
- Removes exhaled air and minimises the misting of eyewear
- Carbon Layer provides protection against ozone gas and relief from nuisance level odours

Code	Description	Pack
3M9925	Premium Welding Respirator	10
3M9928	Premium Welding Respirator	10

### 3M K112



FFP2  
APF: 10

**3M**



EN149

Suitable for  
car body  
preparation

- Offers simple cost effective protection against moderate levels of fine dusts and water-based mists
- Flat fold design for easy storage
- Diamond-shaped front allows the respirator to maintain its shape in hot and humid conditions
- Exhalation valve for improved comfort in hot and humid environments
- Assigned Protection Factor of 10

Code	Description	Pack
3MK112	K112 FFP2 Valved Value Respirator	10

### Honeywell 5311



FFP3  
APF: 20

**Honeywell**



EN149

Suitable for  
car body  
preparation

- Offers simple cost effective protection against toxic dusts, fumes and water-based mists
- Features a pre-shaped nose-bridge and an exhalation valve
- Lightweight (18g) to reduce wearers' fatigue
- Latex, silicone and PVC free
- Assigned Protection Factor of 20

Code	Description	Pack
WIL1015635	5311 FFP3 Valved Value Respirator	10

### Honeywell Valuair



**Honeywell**

- Silicone free
- Made of robust yet comfortable thermoplastic elastomer
- Four-strap stable monobloc harness for optimised wearer tolerance
- Click-fit cartridge fastening system for ultimate safety
- To be used only with T-series filters (sold separately)

Code	Description	Pack
WIL1001573	Valuair Half-Mask Medium 109g (79900500)	10
WIL1001574	Valuair Half-Mask Large 113g (79900501)	10
WIL1001620	T411 A1P3 Organic Vapour & Particulate Filter	3 pairs
WIL1001583	T41 A2P3 Organic Vapour & Particulate Filter	3 pairs

#### Gas & Vapour Protection explained

EN 14387, the European standard for gas filters, classifies gases and vapours into the following groups, each of which are designated a standard colour coding.

**A** - Organic vapours (boiling point >65°C ie. xylene and toluene)

**B** - Inorganic vapours ie. chlorine and bromine

**E** - Acid gases ie. sulphuric acid

**K** - Ammonia and its derivatives

**AX** - Organic vapours (boiling point <65°C ie, acetone and bromoethane)

1 after the letter denotes Class 1 - 2 after the letter denotes Class 2 - Class 2 has higher gas capacity than Class 1

Depending on the filter you select, your 3M respirator can protect against particulates, gases and vapours or a combination of the two. To select the most appropriate filter for a particular chemical or hazard, please call the 3M Health & Safety helpline on 0870 60 800 60 (UK) or 1 800 320500 (ROI).

### 3M 4000 Series Maintenance Free Respirators

Shown 3M™4251



- 3M 4000 Series Semi-Usable Respirators incorporate a unique design with integral filters
- Exempt from the maintenance requirements of the COSHH regulations if disposed of within the month
- Low profile styling for better peripheral vision
- Soft, non-allergenic material with textured face seal
- Central position for effective removal of heat and moisture build up within face piece
- Adjustable head cradle and neck straps ensures a stable secure fit
- Resealable bag provides convenient and clean storage
- Overspray guard for 4000 series respirators (shown below)
- Simply fits over the particulate filters and acts as a "spray-mist" pre-filter

Below Overspray Guard



**3M**

EN405



Code	Description	Pack
3M4251	4251/6941 A1P2R D Organic Vapour & Particulate Respirator	1
3M4255	4255/6942 A2P3R D Organic Vapour & Particulate Respirator	1
3M4277	4277 ABE1P3RD Organic Vapour/Inorganic + Acid Gas/Particulate Respirator	1
3M4279	4279 ABEK1P3RD Organic Vapour/Inorganic + Acid Gas/Ammonia/Particulate Respirator	1
3M400	400 Overspray Guard for 4000 Series Respirators	10

### 3M 7500 Series Reusable Half Mask

3M 7500 series reusable half masks have set a new standard. The 3M™ Cool Flow™ Exhalation Valve reduces breathing resistance, helping to minimise heat build-up in the mask and increasing your comfort.

All masks have the 3M Bayonet Attachment System offering a broad range of twin lightweight filters to protect against gases, vapours and particulates depending on your individual needs and can also be used with 3M™ Supplied-Air Systems



- Balanced, secure fit
- Reduced pressure and tension points
- Drop down feature for added convenience during breaks
- Fits well with 3M Head and Eye protection
- Soft silicone material for comfort and durability
- Easier breathing
- Less heat and moisture build-up

**3M**

EN140



Code	Description	Pack
3M7501	7500 Reusable Half-Mask - Small	1
3M7502	7500 Reusable Half-Mask - Medium	1
3M7503	7500 Reusable Half-Mask - Large	1



### 3M 6000 Series Reusable Half Masks



**3M**

- 3M6000 Series reusable masks are economical, low-maintenance, simple to handle and extremely lightweight
- Available in three sizes - small, medium & large
- More simplicity for easy handling
- Flexible system (gas/vapour and/or particulate filters plus Supplied-Air option)

Code	Description	Pack
3M6100S	6000 Reusable Half-Mask - Small	1
3M6200M	6000 Reusable Half-Mask - Medium	1
3M6300L	6000 Reusable Half-Mask - Large	1

Filters for  
6000 & 7500 Series

Code	Description	Pack
3M6051	6051/6911 A1 Gas/Vapour Filter	8
3M6055	6055/6915 A2 Gas/Vapour Filter	8
3M2125	2125 P2R Particulate Filter	20
3M2135	2135 P3R Particulate Filter	20
3M5935	5935 P3R Particulate Pre-Filter	20
<i>Particulate Pre-Filter to be used with 501 Retainer</i>		
3M501	501 Filter Retainer	2
<i>501 Retainer to clamp pre-filters on to gas &amp; vapour filters</i>		

EN140



### 3M 6000 Full Face Masks

3M 6000 Series Full Face Mask is one of the lightest, most well balanced masks available with long wearing comfort and easy fit



**3M**

EN136

- Soft, hypo-allergenic elastomeric face piece
- Extremely lightweight (410 grams)
- Broad field of vision
- Polycarbonate lens, scratch and impact resistant to EN166:B

#### 3M™ Cool Flow™ Valve

- Helps reduce heat build-up inside the respirator
- Humid exhaled air escapes efficiently through the valve
- Centre position and innovative design effectively manages the removal of exhaled air

- Twin filter design gives a more balanced fit by avoiding a heavy single filter at the front
- Swept back filter positioning for unobstructed field of vision
- Large range of cost-effective filters
- Unique 3M Bayonet Filter attachment system for a safe and secure fit

Code	Description	Pack
3M6900S	3M6000 Full Face Mask	1

# ▶▶ Safety & PPE

## Mechanical Hand Protection - General Purpose

### Honeywell Dexgrip Light



**Honeywell**



- For handling for abrasive & slippery objects
- Knitted cotton glove/polyamide blue
- The latex coating is light & very flexible to give excellent dexterity

Code	Size	Pack
PER20-941-50-9	9	10
PER20-941-50-10	10	10

### Honeywell Split Rigger Brown



**Honeywell**



- For use in heavy handling of sharp metal parts in oily or greasy environments
- Cow slip leather, split leather palm, canvas lining
- Elasticated on the back
- Canvas cuff of 70mm

Code	Size	Pack
PER20-000-93-10	10	10

### Honeywell Polytril™ Top



**Honeywell**



- For use in general handling in wet & oily conditions
- Knitted polyamide liner with oil/liquid repellent nitrile
- Fully coated with knit wrist

Code	Size	Pack
PER22-322-36-9	9	10
PER22-322-36-10	10	10

### Honeywell Polytril™ Black



**Honeywell**



- For handling of abrasive parts in a greasy & oily environment
- Black knitted polyamide gloves
- Black oil proof nitrile coating on palm and fingertips

Code	Size	Pack
PER22-322-21-9	9	10
PER22-322-21-10	10	10

### Honeywell Perfect Poly Black



**Honeywell**



EN388  
2 1 4 1



EN420

- Handling in dry environments & requiring excellent dexterity
- Black polyamide with grey polyurethane coating at the palm and fingertips
- Silicone-free

Code	Size	Pack
PER24-002-51-9	9	10
PER24-002-51-10	10	10

### Weldas Working



**WELDAS®**



EN388  
2 1 4 3



EN420

- For use in general handling offering protection from mechanical hazards
- Cotton lined glove
- Safety coloured
- 7.5cm cuff

Code	Size	Pack
WEL10-2209L	L	10

### Weldas Driving



**WELDAS®**



EN388  
2 1 4 2



EN420

- Versatile & comfortable protection
- Fingertip sensitive
- Soft top grain palm & side slit back cowhide

Code	Size	Pack
WEL10-2336L	L	10

### Futuris Canadian Riggers



**FUTURIS®**



EN420  
Minimal Risk only

- General work gloves
- Elasticated cotton fabric back
- Pasted cuff
- Length 25cm

Code	Size	Pack
060233	L	10

# ►► Safety & PPE

## Mechanical Hand Protection - Cut Protection

### Futuris Furniture Hide Riggers



- For use in general handling
- Assorted colour leather
- Elasticated cotton fabric back
- Leather reinforced palm
- Length 25cm

**FUTURIS**



Minimal Risk only

Code	Size	Pack
060232	L	10

### Futuris Red Rust Riggers



- General work gloves
- Red cow split leather palm
- White elasticated cotton fabric back
- 7cm rubberised cuff
- Length 25cm

**FUTURIS**



Minimal Risk only

Code	Size	Pack
060262	L	10

### Honeywell Aracut Grip



- For general handling of slippery parts with cutting risks
- 100% KEVLAR® knitted glove
- PVC polka dot pattern at the palm & back
- Good grip and dexterity

**Honeywell**



Code	Size	Pack
PER20-320-83-9	9	10
PER20-320-83-10	10	10

### Honeywell Dynaglass Latex



- Handling of heavy, sharp parts with cutting edges
- DYNEEMA® glass/polyamide glove
- Latex coating at palm and fingertips

**Honeywell**



Code	Size	Pack
PER22-321-12-09	9	10
PER22-321-12-10	10	10

### Honeywell Green Welding Gauntlets



**Honeywell**

Heavy handling, multi-purpose & multi-welding type glove

- Prevalent in ARC Welding
- Split leather; KEVLAR® seams
- Reinforced palm, fully lined interior

Code	Size	Pack
PER20-000-42-9	9	10
PER20-000-42-10	10	10

### Honeywell Blue Welding Gauntlets



**Honeywell**

For use in welding & heavy-handling

- Palm and back in cowhide split leather
- Heat resistant
- Length 34cm

Code	Size	Pack
PER20-000-44-9	9	10
PER20-000-44-10	10	10

### Honeywell TIG Welding Gauntlets



**Honeywell**



- For use in TIG Welding
- Five finger grain leather glove
- Grain goat leather palm and back
- 15cm cuff in split leather

Code	Size	Pack
PER20-128-04-9	9	10
PER20-128-04-10	10	10

### Honeywell MIG Fit



**Honeywell**



- For use in ARC & MIG Welding
- KEVLAR® Aluminised fabric back
- Fully lined in cotton fleece
- Cowhide split leather treated for heat resistance

Code	Size	Pack
PER20-586-91-10	10	10
PER20-596-91-11	11	10

### Weldas Softouch Top Grain TIG

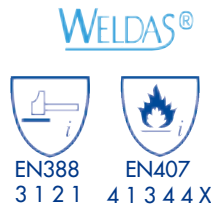

- For use in TIG Welding
- Top grain reverse pigskin
- Reinforced thumb
- KEVLAR® 3x
- Length 35cm



Code	Size	Pack
WEL10-1003L	L	10

### Weldas Softouch Top Grain Goatskin and L/W Goatskin



- For use in TIG Welding
- Grain lightweight goatskin
- Split cowhide cuff
- KEVLAR® 3x
- Length 35cm



Code	Size	Pack
WEL10-1007L	L	10
WEL10-1009L	L (L/W)	10

### Weldas Bucktan Shoulder Reinforced Thumb

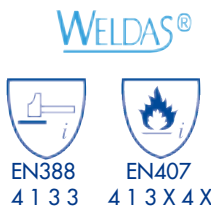

- For general welding
- COMFOflex® lining
- Air cushioned
- KEVLAR® 4x + 5x
- Length 35cm / 46cm



Code	Size	Pack
WEL10-2000L	L	10

### Weldas Blue Shoulder Cowhide

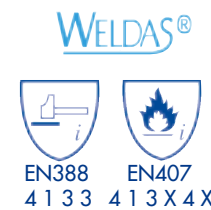

- Multi-purpose, multi-welding type glove
- COMFOflex® lining
- Blue shoulder split cowhide
- KEVLAR® 3x
- Length 35cm



Code	Size	Pack
WEL10-2087L	L	10

### Weldas Aluminised Back

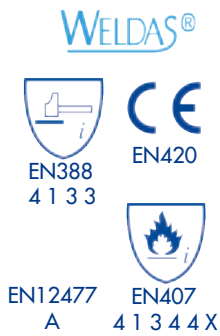

- Use when you need to reflect radiant heat
- COMFOflex® lining
- Split deerskin with aluminized back
- KEVLAR® 4x

Code	Size	Pack
WEL10-2385L	L	5

### Weldas Straight Reinforced Thumb



- For use in handling of MIG guns
- Straight with reinforced thumb
- Cotton lined glove
- KEVLAR® 3x
- Length 35cm / 46cm

Code	Size	Pack
WEL10-2392L RF/Thumb	L	10
WEL10-2392LH RF/Thumb Single Left Hand Only	L	10

### Weldas High Heat Aluminium Handshield



- For use in areas of high heat
- Reflective Aluminized handshield
- Split cowhide leather and sewn KEVLAR® thread
- 15cm x 20cm L

Code	Size	Pack
WEL44-3006	PAIR	10



## Full Speedglas range available!



**Speedglas™**

### Futuris Goatskin Leather Glove



- For use in general work requiring dexterity and sensitivity
- Goatskin leather glove
- 16cm cow split leather cuff
- Wing thumb
- Length 37cm

Code	Size	Pack
060231	L	10

### Futuris Green Superior Gauntlet



- For use in heavy handling
- Split leather green gauntlet
- Cotton fleece lining
- Wing thumb
- Length 35cm

Code	Size	Pack
060236S	L	10

### Futuris Red Welders Gauntlet



- For use in welding applications. Cat 2.
- Split leather red gauntlet
- Cotton fleece lining
- Wing thumb
- Length 35cm

Code	Size	Pack
060249	L	10

### Futuris Gauntlet Reinforced Palm



- For use in welding applications. Cat 2.
- Reinforced palm, thumb & forefinger
- KEVLAR thread for added heat and cut resistant

Code	Size	Pack
FUTGAUNTREIN	11	10



### Honeywell Winter Fit



**Honeywell**



EN420



EN511  
1 2 X



EN388  
3 2 2 3

- For outdoor & indoor work in cold & wet environments
- Docker type glove
- Water-repellent insert
- Full Thinsulate® lined insert

Code	Size	Pack
PER20-000-98-9	9	10

### Honeywell Deerfit Lux



**Honeywell**



EN420



EN511  
1 2 X



EN388  
2 X 1 X

- For outdoor & indoor work in cold & wet environments
- Water-repellent suede leather glove with Thinsulate® liner for protection against cold temperatures

Code	Size	Pack
PER20-016-10-10	10	10

### Honeywell Velvet Shock



**Honeywell**



EN420



EN388  
2 1 2 2

- For use with pneumatic hammer tools in a wet and greasy environment
- Anti-shock and anti-vibration cowhide leather
- Water-repellent grain palm
- Latex wrist

Code	Size	Pack
PER20-491-32-9	9	10
PER20-491-32-10	10	10

### Honeywell Cryogenic



**Honeywell**



EN420



EN511  
2 2 X



EN388  
3 2 2 2

- For use in handling & transport of liquid gas
- Dual insulation, special cryogenics
- Tested to - 170°C

Code	Size	Pack
PER20-586-85-10	10	10

### Honeywell Dexpure™ 800-21



**Honeywell**



- For light short-term work requiring a clean environment & dexterity
- DEXPURE™ 800-21
- Powdered Latex
- Natural colour
- Box of 100 gloves

Code	Size	Pack
PER45-800-21-09	9	100
PER45-800-21-10	10	100

### Honeywell Dexpure™ 800-81



**Honeywell**



- For light short-term work requiring a clean environment & dexterity
- DEXPURE™ 800-81
- Non-powdered Latex
- Blue in colour
- Box of 100 gloves

Code	Size	Pack
PER45-800-81-09	9	100
PER45-800-81-10	10	100
PER45-800-81-11	11	100

### Honeywell Powercoat™ 948-31 Nitraf



**Honeywell**



- High performance chemical protection
- POWERCOAT™ 948-31
- Nitrile unlined
- Cotton flock interior
- Patterned finish

Code	Size	Pack
PER20-948-31-9	9	10
PER20-948-31-10	10	10

### Honeywell Dexpure™ 800-01



**Honeywell**





- For light short-term work requiring a clean environment & dexterity
- DEXPURE™ 800-01
- Powdered vinyl
- Natural colour
- Box of 100

Code	Size	Pack
PER45-800-01-09	9	100
PER45-800-01-10	10	100

### Hand Protection Standards

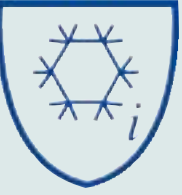
 <b>EN 388</b> <b>Mechanical Hazards</b>	1	2	3	4	5
	A. Abrasion resistance - in number of cycles	>100	>500	>2000	>8000
B. Cutting resistance - (slicing) - index	> 1,2	>2,5	>5,0	>10,0	>20,0
C. Tear resistance - in newtons	>10	>25	>50	>75	-
D. Perforation resistance - in newtons	>20	>60	>100	>150	-
X. Not tested for this hazard					

 <b>EN 511</b> <b>Protection in Cold Temperatures</b>	1	2	3	4	5
	A. Resistance to conductive cold - thermal insulation in m <sup>2</sup> °C/W	≥ 0,10	≥ 0,15	≥ 0,22	≥ 0,30
B. Resistance to contact (cold) - thermal resistance in m <sup>2</sup> °C/W	≥ 0,025	≥ 0,050	≥ 0,100	≥ 0,150	-
C. Water permeability - Level 1 Watertight/minimum 30mm					
X. Not tested for this hazard					

 <b>EN 407</b> <b>Heat and/or Fire</b>	1	2	3	4	5
	A. Behaviour and /or Fire - Length of fire persistence to flame	≥ 20"	≥ 10"	≥ 3"	≥ 2"
B. Resistance to contact heat - > 15 seconds	100 °C	250 °C	350 °C	500 °C	-
C. Resistance to convective heat - heat transmission	≥ 4	≥ 7	≥ 10	>18	-
D. Resistance to radiant heat - heat transmission	≥ 4	≥ 30	≥ 90	>150	-
E. Resistance to small metal splashes - no. of drops needed for metal liquid to obtain a rise in temperature of 40 °C	≥ 5	≥ 15	≥ 25	>35	-
F. Resistance to molten metal splashes - weight (in grammes) of molten iron needed to cause a superficial burn	≥ 30	≥ 60	≥ 120	>200	-

 <b>EN 374</b> <b>Chemical Hazards</b>	EN 374-3 List of Chemicals			<p>A pictogram can be placed on the glove if it has undergone a chemical resistance test (air leak test). Regardless of the value of the tests carried out on protective glove, they are conducted in a laboratory under conditions coming as close as possible to real conditions of use. As soon as the results are obtained from approved laboratories, the manufacturer will provide the following information for each glove and each chemical used: A permeation index (from 0 to 6) that represents the time it takes for a molecule of a chemical to go through the glove. Due to a large number of chemicals involved and the complexity of the test, a complete list of results can not be provided.</p>
	LETTER CODE	CHEMICALS	NUMBER CAE	
A	Methanol	67-56-1	Primary alcohol	
B	Acetone	67-64-1	Ketone	
C	Acetonitrile	75-05-8	Nitrile	
D	Methyl Chloride	75-09-2	Chlorinated Hydrocarbon	
E	Carbon Disulphur	75-15-0	Organic compound containing sulphur	
F	Toloul	108-88-3	Aromatic hydrocarbon	
G	Diethylamine	109-89-7	Amine	
H	Tetrahydrofurane	109-99-9	Heterocyclic Ether	
I	Ethyl acetate	141-78-6	Ester	
J	N-Heptane	142-85-5	Saturated hydrocarbon	
K	Caustic soda 40%	1310-73-2	Inorganic base	
L	Sulphuric acid 96%	7664-93-9	Inorganic mineral acid	

### Glossary of Glove Terms

**Cuff:** The part of the glove extending beyond the palm that covers the wrist and part of the forearm.

**Gauntlet:** A very long cuff to protect the forearm.

**Grain:** The side of the leather that had the hair, i.e. the outside. Full grain has the original surface, whereas corrected grain has been abraded to make the leather smoother and more uniform.

**Gunn Cut:** A glove style with seams at the base of the fingers. The seams between the fingers are on the back of the glove.

**Split:** When a thick piece of leather is split into two thinner pieces, the top piece will have grain (Top Grain) and the bottom piece will be suede on both sides. The bottom piece is the split.

# ▶ Safety & PPE

## Ear Protection - Disposable Earplugs

### Ear Protection Safety Standards

#### EXCESSIVE DECIBELS ARE HARMFUL TO YOUR HEALTH

We are born with about 20,000 hair cells in each ear. Noise above 80 decibels can destroy these cells and gradually cause *irreversible* damage and noise induced hearing loss. To minimise the risk of harm from excessive decibels, ensure that you choose the hearing protection that is best suited to your noise exposure levels.



Certifies only that the product and its manufacture has met the basic safety requirements under directive 89/686/EEC. The product must therefore be checked to ensure it has certification in the EN352 standard for its required use.

**EN352/1** Head band (Ear Defenders)

**EN352/2** Earplugs

**EN352/3** Headbands mounted on earphones (helmet ear defenders)

**dB** Decibel

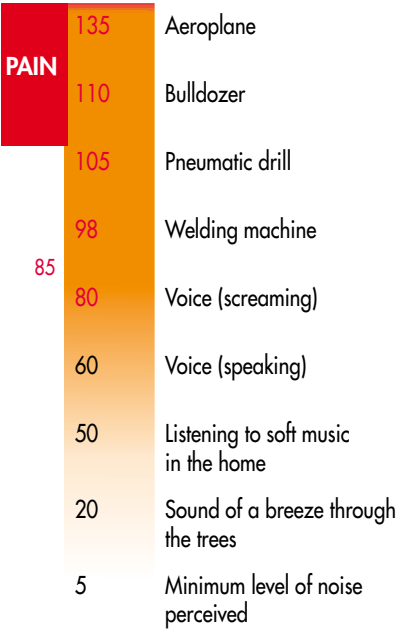

Employer Standards	Constant Noise	Peak Noise
Hearing Protection must be worn	85 dB	137 dB
Hearing protection must be made available to employee	80 dB	135 dB

*European Directive 2003/10/EC published on the Official Journal of the European Union*

Products without legitimate certification may damage your health irreversibly.

### Howard Leight LaserLite Earplugs

Foam



- Vibrant colours makes protection visible
- Self-adjusting foam expands to fit virtually every wearer
- Contoured T-shape for easy insertion and wear



by Honeywell



**EN352/2**

SNR=35 H=34 M=32 L=31								
Frequency Hz	63	125	250	500	1000	2000	4000	8000
Mean Value dB	33.4	34.1	35.5	37.6	34.9	35.7	42.5	44.1
Standard Deviation dB	4.6	4.7	4.6	4.1	5.0	2.8	2.9	4.2
Assumed Protection dB	28.8	29.4	30.9	33.5	29.9	32.9	39.6	39.9

Code	Description	Pack
HOW3301105	Uncorded - individual packs	200
HOW1013047	Uncorded - Refill - 200 pairs	1
HOW3301271	Uncorded - Refill - 500 pairs	1
HOW3301106	Corded - 100 pairs	10

### Howard Leight Max Earplugs

Foam



- World's most used polyurethane earplug
- Bell shape delivers maximum in-ear comfort
- Smooth, soil resistant skin prevents dirt build up



by Honeywell



**EN352/2**

SNR=37 H=36 M=35 L=34								
Frequency Hz	63	125	250	500	1000	2000	4000	8000
Mean Value dB	34.6	37.1	37.4	38.8	38.2	37.9	47.3	44.8
Standard Deviation dB	3.0	4.5	4.3	3.7	3.5	4.0	3.5	7.2
Assumed Protection dB	31.6	32.6	33.1	35.1	34.7	33.9	43.8	37.6

Code	Description	Pack
HOW3301161	Uncorded - 200 pairs	10
HOW1013046	Uncorded - Refill	1
HOW3301130	Corded 100 pairs	10

### Howard Leight 303 L Earplugs



HOWARD LEIGHT  
by Honeywell



#### Earplugs

- Smooth tapered shape for easy insertion and removal
- Soft polyurethane foam plug adjusts comfortably in the ear
- Smooth outer surface for better hygiene

#### Dispenser

- Can be mounted to the wall or set on a table-top
- Fully transparent so it can be refilled before empty
- Handy catch basin to prevent earplug spillages
- Dispenser parts are 100% reusable

	SNR=33 H=32 M=29 L=29							
Frequency Hz	63	125	250	500	1000	2000	4000	8000
Mean Value dB	28.4	37.3	37.9	39.1	36.0	34.6	42.5	46.4
Standard Deviation dB	6.4	9.0	9.2	9.7	7.9	4.6	4.9	4.7
Assumed Protection dB	22.0	28.3	28.7	29.4	28.1	30.0	37.6	41.8

Code	Description	Pack
BIL1005073	Uncorded 303L - 200 pairs	10
BIL1006186	Uncorded 303L NST - 400pairs	10
BIL1006202	Dispenser	1

### 3M E.A.R Classic Earplugs



- World's most popular roll down ear plugs
- Soft energy-absorbing foam
- Reusable pillow pack to keep ear plugs clean
- Humidity absorption-resistant to help reduce movement & shifting problems

	SNR=28 H=30 M=24 L=22							
Frequency Hz	63	125	250	500	1000	2000	4000	8000
Mean Value dB	22.3	23.3	24.6	26.9	27.4	34.1	41.6	49.4
Standard Deviation dB	5.4	5.3	3.6	5.4	4.8	3.1	3.5	6.4
Assumed Protection dB	16.9	18.1	20.9	21.5	22.6	30.9	38.1	34

Code	Description	Pack
3MEPP-01-002	Uncorded - Box 250	1

### 3M 1100 Earplugs



- Soft, smooth tapered foam offering maximum comfort
- Hypo-allergenic and dirt resistant
- 3M1311 soft, replacement plug for 3M1310 banded ear plugs

	SNR=37 H=37 M=34 L=31							
Frequency Hz	63	125	250	500	1000	2000	4000	8000
Mean Value dB	30.0	33.1	36.3	38.4	38.7	39.7	48.3	44.4
Standard Deviation dB	3.9	5.0	7.4	6.2	5.6	4.3	4.5	4.4
Assumed Protection dB	26.1	28.1	28.9	32.2	33.1	35.4	43.8	40.0

Code	Description	Pack
3M1100	Uncorded - Box 200	1
3M1110	Corded - Box 100	1
3M1100R	Uncorded - Dispenser Refill	500
3M1310	Banded Ear Plugs	10
3M1311	Replacement plugs for 1310	20

# ► Safety & PPE

## Ear Protection - Reusable Earplugs

### Howard Leight SmartFit® Earplugs



- Advanced material using body heat to adapt to the individual shape of each wearer's ear canal
- Delivers superior comfort and an individual fit
- HearPack® storage case; unique detachable cord system



SNR=30 H=32 M=27 L=23								
Frequency Hz	63	125	250	500	1000	2000	4000	8000
Mean Value dB	30.9	31.4	28.8	32.5	33.8	5.6	39.3	41.9
Standard Deviation dB	6.2	7.3	8.9	8.1	7.3	4.3	6.0	5.0
Assumed Protection dB	24.7	24.1	19.9	24.4	26.5	31.3	33.3	36.9

Code	Description	Pack
HOW1011239	Corded - 50 pairs	1

### Howard Leight Quiet® Earplugs

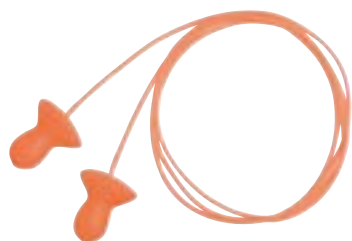

- Patented "no-roll" design is easy to handle & fit
- Contoured shape comfortably matches contour of the ear canal
- Built-in insertion stem



SNR=28 H=29 M=25 L=23								
Frequency Hz	63	125	250	500	1000	2000	4000	8000
Mean Value dB	26.1	29.0	38.8	29.1	29.5	33.1	43.3	44.5
Standard Deviation dB	6.1	6.9	6.4	7.2	5.1	5.3	6.9	3.4
Assumed Protection dB	20.0	22.1	2.4	21.9	24.4	27.8	36.4	41.1

Code	Description	Pack
HOW3301172	Corded - 100 pairs	1

### Howard Leight PerCap Banded Earplugs

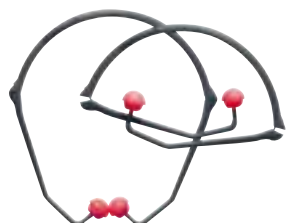

- Semi-aural protection; super soft pods rest outside the ear canal opening
- Multiple position wear provides flexibility in wear
- Compact, folding design easy to store in pocket
- Ideal for workers who are exposed to intermittent noise



SNR=24 H=27 M=20 L=18								
Frequency Hz	63	125	250	500	1000	2000	4000	8000
Mean Value dB	21.4	22.5	21.5	19.0	22.6	30.3	35.7	38.8
Standard Deviation dB	4.8	3.5	3.6	2.9	2.7	3.1	4.2	4.3
Assumed Protection dB	16.6	19.0	17.9	16.1	19.9	27.2	31.5	34.5

Code	Description	Pack
HOW1005952	PerCap	10

### 3M E.A.R ClearEAR Earplugs



- Designed to be discreetly worn as virtually invisible when fitted
- Made from transparent polymer
- Comfortable and reusable
- Can be washed & stored in case provided

SNR=20 H=25 M=17 L=10								
Frequency Hz	63	125	250	500	1000	2000	4000	8000
Mean Value dB	7.2	9.0	11.9	17.6	23.9	28.9	32.1	35.8
Standard Deviation dB	5.1	4.5	3.9	3.6	3.1	3.6	7.1	4.2
Assumed Protection dB	2.1	4.5	8.0	14.0	20.8	25.3	25.0	31.6

Code	Description	Pack
3MPHARMA	Uncorded	20

### Futuris Ear Defenders



**FUTURIS**™

- Economy Ear Muff
- CE EN352-1, SNR:27dB
- Lightweight and comfortable

CE

EN352/1

Code	Description	Pack
FUTEARMUFF	Headband	1

### Futuris Folding Ear Defenders



**FUTURIS**™

- Economy folding ear muffs
- CE EN352-1, SNR:29 dB
- Light-weight, heavy duty hearing protection
- Foldable

CE

EN352/1

Code	Description	Pack
FUTFOLDEARMUFF	Folding Headband	1

### Howard Leight Mach 1 Headband



**HOWARD LEIGHT**  
by Honeywell

CE

EN352/1

- Economical design providing adequate protection at a low cost
- Extremely lightweight construction
- Dielectric construction suitable for all workplaces

	SNR=23 H=29 M=20 L=13							
Frequency Hz	63	125	250	500	1000	2000	4000	8000
Mean Value dB	14.4	13.3	11.7	17.6	31.8	30.9	34.7	31.4
Standard Deviation dB	3.8	2.9	1.8	2.4	2.9	2.8	2.4	4.9
Assumed Protection dB	10.6	10.4	9.9	15.2	28.9	28.1	32.3	26.5

Code	Description	Pack
HOW100421	Mach 1 Headband	1

### Howard Leight Lightning LON Neckband



**HOWARD LEIGHT**  
by Honeywell

CE

EN352/1

- Includes elastic headband strap for better positioning
- Ultraslim, lightweight ear cups for extra comfort
- Sleek anatomic behind-the-head design

	SNR=22 H=24 M=19 L=14							
Frequency Hz	125	250	500	1000	2000	4000	8000	
Mean Value dB	10.7	17.2	19.9	22.0	26.6	35.6	39.9	
Standard Deviation dB	4.3	4.1	1.8	3.5	4.4	3.1	3.0	
Assumed Protection dB	6.4	13.0	18.1	18.4	22.1	32.5	36.9	

Code	Description	Pack
HOW1013460	Lightning LON Neckband	1

### 3M Peltor Optime I - Headband & Neckband



EN352/1



- Ideal for moderate industrial noise
- Versatile protection, very lightweight, high comfort
- Low profile ear defender with generous inner depth making it easy to combine with other equipment
- Optimum seal with a sealing rings filled with liquid & foam

	SNR=27 H=32 M=25 L=15							
Frequency Hz	63	125	250	500	1000	2000	4000	8000
Mean Value dB	14.1	11.6	18.7	27.5	32.9	33.6	36.1	35.8
Standard Deviation dB	4.0	4.3	3.6	2.5	2.7	3.4	3.0	3.8
Assumed Protection dB	10.1	7.3	15.1	25.0	30.1	30.2	33.2	32.0

Code	Description	Pack
3MH510A-401-GU	Headband	1
3MH510-403-GU	Neckband	1

### 3M Peltor Optime II - Headband



EN352/1



- Developed for environments with substantial industrial noise
- Sealing rings filled with a unique combination of liquid & foam
- Optimum seal with low contact pressure & snug comfort
- Ventilation channels & hygienic foil

	SNR= 31 H=34 M=29 L=20							
Frequency Hz	63	125	250	500	1000	2000	4000	8000
Mean Value dB	16.2	14.6	20.2	32.5	39.3	36.4	34.4	40.2
Standard Deviation dB	1.9	1.6	2.5	2.3	2.1	2.4	4.0	2.3
Assumed Protection dB	14.3	13.0	17.7	30.2	37.2	34.0	30.4	37.9

Code	Description	Pack
3MH520A407GQ	Headband	1



### 3M Peltor Optime II - Neckband & Folding Headband



CE  
EN352/1



- Developed for environments with substantial industrial noise
- Sealing Rings filled with a unique combination of liquid & foam
- Optimum seal with low contact pressure & snug comfort
- Ventilation channels & hygienic foil

SNR=31H=34 M=29 L=20								
Frequency Hz	63	125	250	500	1000	2000	4000	8000
Mean Value dB	15.9	14.7	20.4	32.3	39.6	36.2	35.4	40.2
Standard Deviation dB	2.1	1.8	2.6	2.5	2.2	2.4	4.2	2.4
Assumed Protection dB	13.8	12.9	17.8	29.8	37.4	33.8	31.2	37.8

Code	Description	Pack
3MH520B408GQ	Neckband	1
3MH520F409GQ	Folding Headband	1

### 3M Peltor Optime III - Headband & Neckband



CE  
EN352/1



- Developed for use in extremely noisy environments
- Superior protection with double casing technology that minimises resonance
- Broad sealing rings filled with soft plastic foam for "best fit" and low contact pressure

SNR=35 H=40 M=32 L=23								
Frequency Hz	63	125	250	500	1000	2000	4000	8000
Mean Value dB	20.9	17.5	24.5	34.5	41.4	39.5	47.3	42.0
Standard Deviation dB	3.3	2.3	2.7	2.0	2.2	2.0	4.4	2.8
Assumed Protection dB	17.6	15.2	21.8	32.5	39.2	37.5	42.9	39.2

Code	Description	Pack
3MH540A411SV	Headband	1
3MH540B412SV	Neckband	1

# ► Safety & PPE

## Ear Protection - Electronic Ear Defenders

### 3M Peltor SportTac Electric Hunting Headband



- Specially designed for hunters and marksmen
- Unique digital sound circuit eliminates the sharp sound clip typical on most level dependent hearing protectors
- Audio input for external radio & mobile phone, battery life span c.600 hours
- Shell/cup covers available for use with Peltor Sporttac Headset



EN352/1

	SNR=26 H=29 M=23 L=16							
Frequency Hz	125	250	500	1000	2000	4000	8000	
Mean Value dB	21.1	17.9	27	26.8	30.5	38.3	36.4	
Standard Deviation dB	4.3	3.1	3.8	3	3	3.7	5.4	
Assumed Protection dB	7.8	14.8	23.2	23.8	27.5	34.6	31	

Code	Description	Pack
3MHMT16H210F-RD	Black & Red Headband	1
3MHMT16H210F-GN	Orange & Green Headband	1

Code	Description	Pack
3MH210100478-SV	Black Shell Covers	1
3MH210100478-GN	Green Shell Covers	1
3MH210100478-OR	Orange Shell Covers	1
3MH210100478-RD	Red Shell Covers	1
3MH210100478-VI	White Shell Covers	1

### 3M Peltor Pro-Tac II Hunting Headband

shown here in green



- Active - volume function keeps you in touch with surroundings whilst protecting your ears from harmful noise and impulse sounds like gunshots
- Battery life span. c.270 hours
- High-attenuating shells, Push To Talk (PTT) button on shell
- Audio input for external radio & mobile phone

	SNR=32 H=31 M=29 L=24							
Frequency Hz	125	250	500	1000	2000	4000	8000	
Mean Value dB	19.7	25.4	31	34.6	32.2	38.7	42.1	
Standard Deviation dB	3.4	2.5	3.4	1.8	3.6	3.8	3.6	
Assumed Protection dB	16.3	22.9	27.6	32.8	28.6	34.9	38.5	

Code	Description	Pack
3MHMT15H74A2-SV	Black Headband	1



EN352/1

### Howard Leight Impact Sport Electronic Folding Headband



EN352/1



- Blocks Impact Noise from gun shots and heavy impact noise machines
- Amplifies ambient sound to avoid isolation
- Directionally placed stereo microphones to provide natural hearing
- Air Flow Control Technology™ to deliver optimal attenuation across all frequencies

	SNR=25 H27 M=22 L=18							
Frequency Hz	63	125	250	500	1000	2000	4000	8000
Mean Value dB	15.1	15.7	19.1	22.9	27.0	24.4	38.4	40.9
Standard Deviation dB	4.5	3.0	3.1	2.9	2.3	3.3	3.0	3.4
Assumed Protection dB	10.7	12.7	15.9	20.0	24.7	21.1	35.4	37.5

Code	Description	Pack
HOW1013530	Folding Headband	1

### Howard Leight SYNC Stereo Headband

for use with personal audio devices



EN352/1

- Protection at home and in most industrial environments
- SYNC's Volume Management Technology™ for consistent hearing protection
- "Plug in and go" - volume and power control through your MP3, mobile phone or other personal audio device
- D-J inspired sound quality
- Audio input for external radio & mobile phone
- Battery life span c.600 hours

	SNR=31 H32 M=28 L=23							
Frequency Hz	63	125	250	500	1000	2000	4000	8000
Mean Value dB	19.2	21.2	23.1	28.1	31.7	34.1	38.5	39.3
Standard Deviation dB	3.0	3.4	2.4	2.4	3.1	3.1	2.4	3.7
Assumed Protection dB	16.2	17.8	20.7	25.7	28.6	31.0	36.1	35.6

Code	Description	Pack
HOW1030111	SYNC Stereo Headband	1

### Honeywell A800



**Honeywell**

- Affordable sporty style
- Slim profile fits smaller faces
- 9-base polycarbonate abrasion resistant lens
- For work requiring 180° field of vision

Code	Description	Pack
PUL1015370	Clear Lens	10
PUL1015368	TSR Grey Lens	10



EN166

EN170

EN172

### Honeywell Op-Tema



**Honeywell**

- Lightweight with built-in moulded brow bar
- 6-base polycarbonate abrasion resistant lens
- Adjustable nosepiece, temple length & lens angle
- Supplied with Flexicord retainer for added security

Code	Description	Pack
PUL1000016	Black Frame - Clear Lens	10
PUL1000018	Blue Frame - Clear Lens	10
PUL1000017	Black Frame - TSR Grey Lens	10



EN166

EN170

EN172

### Honeywell Protégé



**Honeywell**

- Expandable wrap-around brow
- Floating lens design for increased flexibility & fit
- Soft nosepiece & temple tip pads
- Suitable for all different face sizes
- I/O Silver lens for Indoor/Outdoor use, only 1 pair instead of 2 (clear & smoke)

Code	Description	Pack
PUL1015366	Clear Lens	10
PUL1015363	TSR Grey Lens	10
PUL1015689	I/O Silver Lens	10



EN166

EN170

EN172

### Honeywell Metalite



**Honeywell**

- Fashionable, exceptionally comfortable to wear for long periods
- Metal frame, sunglasses style
- Lightweight design & advanced comfort
- Flexible temples & soft nose bridge

Code	Description	Pack
PUL1014290	Clear Lens	10
PUL1014293	TSR Grey Lens	10
PUL1014295	Gold Mirror Lens	10



EN166

EN170

EN172

### Honeywell Millennia



**Honeywell**

- Popular with users in most industries
- Sensitive Tension Design for a balanced & comfortable fit
- Parallel Vision Control for greater visual comfort
- Supplied with Flexicord retainer for added security

Code	Description	Pack
PUL1000001	Clear Lens	10
PUL1006405	IR 3 Lens	10
PUL1006406	IR 5 Lens	10



EN166

EN169

EN170

EN171

### Honeywell XC



**Honeywell**

- X-tra Coverage, X-tra Comfort & X-tra Control
- Provides total wrap around coverage with exceptional peripheral vision
- Extra flexible frame, easily replaceable lenses
- Ultra-soft two-shot material

Code	Description	Pack
PUL1010950	Clear Lens	10



EN175

EN166

EN169

EN170

EN171

# ▶▶ Safety & PPE

## Eye Protection - Spectacles

### 3M Tora



**3M**

- 9D curved lens for excellent peripheral vision & protection
- Anti-scratch & anti-fog coated
- Slim nose bridge & flat temples for improved fit with other PPE
- Stylish design, Perfect fit

Code	Description	Pack
3M71501-00001CP	Clear Lens incl. spec cord	10



EN166

EN170

### 3M 2840 Series



**3M**

- Fully adjustable temple length (3 positions)
- Soft inner padding on temple
- Inclinable lens enabling optimal personal fit
- Designed with user comfort & convenience in mind
- Light gold mirror lens for Indoor/Outdoor use, only 1 pair instead of 2 (clear & smoke)

Code	Description	Pack
3M2840	Clear Lens - Anti Fog	20
3M2844	Light Gold Mirror Lens	20
3M2845	IR 5 Lens - Anti-Fog	20



EN166

EN169

EN172

EN170

EN171

### 3M Solus



**3M**

- Optimal field of vision & coverage of the eyes
- Soft inner padding on temple
- Low profile design for improved fit with other PPE
- Stylish & lightweight dual lens spectacles

Code	Description	Pack
3M71505-00001CP	Clear Lens	10
3M71505-00006CP	Red Mirror Lens incl. microfibre pouch	10



EN166

EN170

EN172

### 3M Metaliks Sport



- Adjustable in height & width nosepiece for perfect fitting
- Soft rubber tipped temples for extra comfort
- Strongly curved lens for superior eye coverage & optimal field of vision

Code	Description	Pack
3M71461-00001CP	Clear Lens - Anti-Fog	10
3M71461-00003CP	Blue Mirror Lens	10



### 3M Fuel



- Ventilated nose bridge & temples to reduce fogging
- Temples with anti-torsion system for a head-hugging fit
- Impact, torsion & heat resistant
- Designed to be worn at work, at home or during outdoor leisure activities

Code	Description	Pack
3M71502-00003CP	Titanium Red Mirror Lens	10

incl. microfibre pouch



### 3M Fuel X2



- Ultra efficient blend of comfort and style
- Bold grooved styling, rubber over-moulded adjustable temples and adjustable nose-bridge
- Impact, torsion & heat resistant
- Designed to be worn at work, at home or during outdoor leisure activities

Code	Description	Pack
3M71502-00000M	Clear Lens	10
3M71502-00001M	Bronze Lens	10
3M71502-00002M	Red Mirror Lens	10



# ► Safety & PPE

## Eye Protection - Spectacles

### Bollé Contour - Metal Frame



CE

EN166

EN170

EN172

**bollé**  
S A F E T Y

- Unique model offering essential protection, design & comfort with metal frame
- 21g power protects against impact
- Uses Bollé Safety lens expertise
- Solid lightweight design

Code	Description	Pack
BOLCONTMPSI	Clear Lens	10
BOLCONTMPSF	Smoke Lens	10
BOLCONTMESP	ESP Lens	10

### Bollé Contour



CE

EN166

EN170

EN172

**bollé**  
S A F E T Y

- Unique model offering essential protection, design & comfort
- 21g power protects against impact
- Uses Bollé Safety lens expertise
- Solid lightweight design

Code	Description	Pack
BOLCONTIPSI	Clear Lens	10
BOLCONTIPSF	Smoke Lens	10
BOLCONTIESP	ESP Lens	10

### Bollé Silium



CE

EN166

EN170

EN172

**bollé**  
S A F E T Y

- Lean attractive design with maximum protection & UV filtration
- Nickel free, brass frame with electric insulation
- Flexible nose bridge & "flex" temples offer extra comfort

Code	Description	Pack
BOLSILPSI	Clear Lens	10
BOLSILPSF	Smoke Lens	10

### Bollé Tracker 11



CE

EN166

EN170

EN172

**bollé**  
S A F E T Y

- Provides high protection from all mechanical & chemical risks
- Sports style frame with moulded nose piece, side ventilation and inter-changable foam reinforcement
- Ultra - comfortable and technical

Code	Description	Pack
BOLTRACPSI	Clear Lens	10
BOLTRACPSF	Smoke Lens	10
BOLTRACPSJ	Yellow Lens	10



### Futuris Vital



- Economical
- Sleek & lightweight design
- Cord available for added security

Code	Description	Pack
FUTSPEC-CL	Clear Lens	12
FUTSPEC-SH	Smoke Lens	12
FUTSPEC-CORD	Cord Lens	12

CE

FUTURIS

EN166

### Futuris Shade 5 Welding Spectacles



- Moulded nosebridge
- 4 position adjustable arms
- Scratch & impact resistant polycarbonate lens
- EN166 Shade 5

Code	Description	Pack
060118	Shade 5 Lens	12

CE

FUTURIS

EN166

Specifications	
Weight	34g
Arms	Adjustable
Nose Piece	Hard
Optical Clarity	Class 1

### Futuris Over Spectacles



- Clear wrap-around protection
- One piece polycarbonate
- Fit over most designs of prescription spectacles

Code	Description	Pack
060112	Clear Lens	10

CE

FUTURIS

Specifications	
Weight	34g
Arms	Adjustable
Nose Piece	Hard
Optical Clarity	Class 1

### Honeywell V-Maxx



**Honeywell**

- Distortion free peripheral vision
- Anti-fog/scratch - Indirect ventilation
- Rotating strap attachments for easier use with hard hats
- Can be worn over prescription eyewear & half-mask respirators

Code	Description	Pack
PUL1006193	Clear Lens	10
PUL1008111	IR 5 Lens	10



### Honeywell Vistamax



**Honeywell**

- Breathable twin lens system with aluminium condensers for exceptional anti-mist performance
- Front lens = acetate for chemical resistance
- Rear lens = polycarbonate for impact resistance
- Ideal for humid environments

Code	Description	Pack
PUL1002759	Clear Lens - No Vent	1



### Honeywell Flex Seal



**Honeywell**

- The first industrial goggle constructed with a silicone body for an individual perfect fit
- Personally adjustable frame with pivoting clips
- Anti-fog/scratch - Indirect ventilation
- Can be worn over prescription eyewear & half-mask respirators

Code	Description	Pack
PUL1011333	Clear Lens - Fabric Strap	10
PUL1011383	IR 3 Lens - Neoprene Strap	10
PUL1011384	IR 5 Lens - Neoprene Strap	10



### 3M 2890

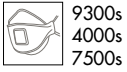

9300s  
4000s  
7500s



**3M**



EN170

EN166

- High performance superior comfort goggles
- Sealed design for protection against liquids, dusts, gases & vapours
- Detachable pivoting ratchet with a narrow fully adjustable headband

Code	Description	Pack
3M2890	Clear Polycarbonate Lens - Indirect Vent	10
3M2890S	Clear Polycarbonate Lens - Sealed	10
3M2890A	Clear Acetate Lens - Indirect Vent	10
3M2890SA	Clear Acetate Lens - Sealed	10

### 3M Modul R



**3M**

#### Half-Visor

- Polycarbonate half-visor with adjustable ventilation system (close or open position)
- Very easy attachment system (attaches to the strap clip)
- Provides complete face protection against liquids, dust & impact
- Can be worn over a dust mask

#### Goggle

- Lightweight low profile goggle providing incredible comfort & protection against impact, dust & chemical splashes
- Anti-scratch & anti-fog coating
- Can be positioned on a helmet

Code	Description	Pack
3M71361-00001CP	Goggle - Indirect Vent	20
3M71361-00003CP	Half Visor	20



EN166

EN170

\*Goggle & visor sold separately

# ► Safety & PPE

## Eye Protection - Goggles

### Futuris LW100

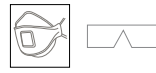

**FUTURIS**

Specifications	
Weight	31g
Arms	B
Nose Piece	Soft
Optical Clarity	Class 1

- Extremely lightweight
- Easily adjustable headband
- Excellent protection against mechanical impacts, flying particles & liquid droplets
- Available in direct & indirect ventilations

Code	Description	Pack
060123	Clear Lens - Indirect Vent	20
060124	Clear Lens - Direct Vent	20

### Futuris Panorama

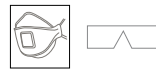

**FUTURIS**

Specifications	
Weight	53g
Arms	B
Nose Piece	Soft
Optical Clarity	Class 1

- Lightweight & flexible gas welding goggle
- Impact resistant plastic lens
- Soft PVC frame which adapts to any face shape

Code	Description	Pack
060125	IR 5 Lens	20

### Futuris 2" Round Cup



Specifications	
Weight	68g
Arms	B
Nose Piece	Soft
Optical Clarity	Class 1

- Suitable for gas welding
- Can be fitted over prescription spectacles

Code	Description	Pack
060121	IR 5 Lens	10
060122	Flip-Up IR 5 Lens	10

**FUTURIS**

EN166



### Futuris Flip Up 4 1/4" x 2"



**FUTURIS**

Specifications	
Weight	68g
Arms	B
Nose Piece	Soft
Optical Clarity	Class 1

- 9D curved lens for excellent peripheral vision & protection
- Anti-scratch & anti-fog coated
- Slim nose bridge & flat temples for improved fit with other PPE
- Stylish design, Perfect fit

Code	Description	Pack
FUT060129	Coloured Lens - 4 1/4" x 2"	10

### Uvex Ultravision



- Sets the benchmark for comfort, field of vision & fit
- Anti-fog & anti-scratch resistant lenses
- Panoramic field of vision
- Indirect ventilation
- Can be worn over most prescription spectacles
- Shade 5 welding goggle has a polycarbonate lens to minimise damage from welding sparks



Code	Description	Pack
UVEX9301-625	Clear Lens - Supravision	4
UVEX9301-045	IR 5	10

**uvex**



### Uvex Ultrasonic



- Lightweight goggle with unrestricted peripheral vision
- Exceptional comfort - even after long periods of wear
- Anti-fog & anti-scratch resistant lenses
- Can be worn over most prescription spectacles



Code	Description	Pack
UVEX9302-645	Orange Frame - Clear Lens	4
UVEX9302-685	Grey Frame - Clear Lens	4

**uvex**

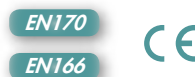

### Honeywell Clearways



- Safe, practical & economical
- Comfortable enough to wear all day (160g)
- Visor 200mm available in acetate & polycarbonate
- Visor & browguard sold separately

**Honeywell**



Code	Description	Pack
PUL1002360	Clear Acetate Visor CV84A	10
PUL1002353	Clear Polycarbonate Visor CV83P	10
PUL1002370	IR5 Acetate Visor CV85/5W	10
PUL1002341	CB20 Browguard - Ratchet	10
PUL1002346	CB14 Browguard - Elastic	10

### Honeywell Bionic



- Extended top of head & chin protection
- Easily replaced visors available in different materials & tints
- Comfortable fit with goggles & respiratory masks
- Locking mechanism for more complete safety
- Incredible adjustability (over 2700 possible wearer positions)
- Extra soft cushioning on all parts of the shield in contact with the head
- Removable breathable headband for easy washing & replacement

**Honeywell**



Code	Description	Pack
PUL1011623	Complete Bionic with Clear Polycarbonate Visor	4
PUL1011933	Complete Bionic with Clear Acetate Visor	4
PUL1011625	Replacement Polycarbonate Visor	10
PUL1011626	Replacement Acetate Visor	10
PUL1011628	Replacement IR3 Visor	10
PUL1011629	Replacement IR5 Visor	10
PUL1015113	Replacement Shell & Headband	4

### Futuris Clear Faceshield



**FUTURIS**™

CE EN166

- Low cost faceshield
- Adjustable headband, provided with a towelling sweatband
- 8" x 12" visor with aluminium bound
- Visor & browguard sold separately

Code	Description	Pack
060511	Clear Visor	50
060512	Browguard	60

### Cleaning Lotion & Tissues



Tissue Dispenser

Towelette Dispenser

**Honeywell**

- Cleaning Lotion is a 500ml spray bottle
- All items alcohol & silicone free
- Tissue Dispenser containing 500 tissues
- Towelette Dispenser containing 100 towelette
- Non abrasive to protect coating

Code	Description	Pack
PUL1011378	500ml Cleaning Lotion	1
PUL1011379	Tissue Dispenser	1
PUL1011332	Towelette Dispenser	1

### Cleaning Station



**uvex**

- Complete lens cleaning station includes:
  - cleaning tissues (450 per box)
  - spray bottle of lens cleaning lotion
  - mirror
  - screws & double sided stickers for wall mounting

Code	Description	Pack
UVEX9990-000	Uvex Complete Cleaning Station	1
UVEX9991-000	Replacement Tissues for Station	1
UVEX9992-000	Replacement Lotion for Station	1

### Microfibre Lens Cleaning Cloth and Pouch



**3M**

#### Lens Cleaning Cloth

- Polyester/polyamide cloth made up of high density micro-filaments
- Washable at 40°C

#### Pouch





























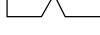

- Soft microfibre pouch with snap clasp for goggle

Code	Description	Pack
3M26-6710-00P	Microfibre Cleaning Cloth	10
3M26-6800-00P	Microfibre Pouch	10

# ▶ Safety & PPE

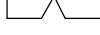

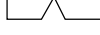
## Eyewear Specifications

### Spectacles









Name	Code	Lens	Coating	Optical Clarity	Impact Protection	Weight	Filter	Applications
A800 Clear	PUL1015370		Anti-Scratch	Class 1	F	22g	UV	Indoor Use
A800 Smoke	PUL1015368		Anti-Scratch	Class 1	F	22g	UV - Solar	Outdoor Use
Op-Tema Clear	PUL1000018/16		Anti-Scratch	Class 1	FT	28g	UV	Indoor Use
Op-Tema Smoke	PUL1000017		Anti-Scratch	Class 1	FT	28g	UV - Solar	Outdoor Use
Protégé Clear	PUL1015366		Anti-Scratch	Class 1	FT	27g	UV	Indoor Use
Protégé Smoke	PUL1015363		Anti-Scratch	Class 1	FT	27g	UV - Solar	Outdoor Use
Protégé I/O	PUL1015689		Anti-Scratch	Class 1	FT	27g	UV, Solar, Glare	Indoor & Outdoor Use
Metalite Clear	PUL1014290		Anti-Scratch	Class 1	F	33g	UV	Indoor Use
Metalite Smoke	PUL1014293		Anti-Scratch	Class 1	F	33g	UV - Solar	Outdoor Use
Metalite Gold Mirror	PUL1014295		Anti-Scratch	Class 1	F	33g	UV, Solar, Glare	Outdoor Use
Millennia Clear	PUL1000001		Anti-Scratch	Class 1	F	32g	UV	Indoor Use
Millennia IR3	PUL1006405		Anti-Scratch	Class 1	F	32g	UV - IR	Brazing, Cutting
Millennia IR5	PUL1006406		Anti-Scratch	Class 1	F	32g	UV - IR	Gas welding, Brazing
XC Clear	PUL1010950		Anti-Scratch	Class 1	F			Indoor Use
Tora Clear	3M71501-00001CP		Anti-Scratch Anti-Fog	Class 1	FT	22g	UV	Indoor Use
2840 Clear	3M2840		Anti-Scratch Anti-Fog	Class 1	FT	26g	UV	Indoor Use
2844 Light Gold	3M2844		Mirror	Class 1	FT	26g	UV, Solar, Glare	Indoor & Outdoor Use
2845 IR5	3M2845		Anti-Scratch Anti-Fog	Class 1	FT	26g	UV - IR	Gas welding, Brazing
Solus Clear	3M71505-00001CP		Anti-Scratch	Class 1	FT	23g	UV	Indoor Use
Solus Red Mirror	3M71505-00006CP		Mirror	Class 1	FT	23g	UV, Solar, Glare	Outdoor Use
Metaliks Sport Clear	3M71461-00001CP		Anti-Scratch Anti-Fog	Class 1	FT	36g	UV	Indoor Use
Metaliks Sport Blue	3M71461-00003CP		Mirror	Class 1	FT	36g	UV, Solar, Glare	Outdoor Use
Fuel Red Mirror	3M71502-00003CP		Mirror	Class 1	FT	-	UV, Solar, Glare	Outdoor Use
Fuel X2 Clear	3M71502-00000M		Anti-Scratch Anti-Fog	Class 1	FT	-	UV	Outdoor Use
Fuel X2 Bronze	3M71502-00001M		Anti-Scratch Anti-Fog	Class 1	FT	-	Solar - Bluelight	Outdoor Use
Fuel X2 Red Mirror	3M71502-00002M		Anti-Scratch Anti-Fog	Class 1	FT	-	Solar - Glare	Outdoor Use
Contour - Clear	BOLCONTIPSI		Anti-Scratch Anti-Fog	Class 1	F	21g	UV	Indoor & Outdoor Use
Contour - Smoke	BOLCONTIPSF		Anti-Scratch Anti-Fog	Class 1	F	21g	Solar Glare	Indoor & Outdoor Use
Contour - ESP	BOLCONTESP		Anti Scratch	Class 1	F	34g	Solar Glare	Indoor & Outdoor Use
Silium - Clear	BOLSILPSI		Anti-Scratch Anti-Fog	Class 1	F	34g	UV	Indoor & Outdoor Use
Silium - Smoke	BOLSILPSF		Anti-Scratch Anti-Fog	Class 1	F	34g	Solar Glare	Indoor & Outdoor Use











### Spectacles

Name	Code	Lens	Coating	Optical Clarity	Impact Protection	Weight	Filter	Applications
Tracker - Clear	BOLTRACPSI		Anti-Scratch Anti-Fog	Class 1	B		UV	Indoor & Outdoor Use
Tracker - Smoke	BOLTRACPSF		Anti-Scratch Anti-Fog	Class 1	B		Solar Glare	Indoor & Outdoor Use
Tracker - Yellow	BOLTRACPSJ		Anti-Scratch Anti-Fog	Class 1	B		Solar Glare	Indoor & Outdoor Use

### Goggles

Name	Code	Lens	Coating	Optical Clarity	Impact Protection	Weight	Filter	Applications
V-Maxx Clear	PUL1006193		Anti-Scratch Anti-Fog	Class 1	B	98g	UV	Indoor Use
V-Maxx IR5	PUL1008111		Anti-Scratch Anti-Fog	Class 1	B	98g	UV - IR	Gas welding, Brazing
Vistamax VNC21	PUL1002759		Anti-Scratch Anti-Fog	Class 1	B	142g	UV	Indoor Use
Flex Seal Clear	PUL1011333		Anti-Scratch Anti-Fog	Class 1	BT	108g	UV	Indoor Use
Flex Seal IR3	PUL1011383		Anti-Scratch Anti-Fog	Class 1	FT	108g	UV - IR	Brazing, Cutting
Flex Seal IR5	PUL1011384		Anti-Scratch Anti-Fog	Class 1	FT	108g	UV - IR	Gas welding, Brazing
2890 Polycarb.	3M2890 & 2890S		Anti-Scratch Anti-Fog	Class 1	BT	-	UV	Indoor Use
2890 Acetate	3M2890A & SA		Anti-Fog	Class 1	FT	-	UV	Indoor Use
Modul R Goggle	3M71361-00001CP		DX	Class 1	BT	-	UV	Indoor Use

### Faceshields

Name	Code	Lens	Coating	Optical Clarity	Impact Protection	Weight	Filter	Applications
Bionic Polycarb.	PUL1011625		None	Class 1	BT	-	UV	Indoor Use
Bionic Acetate	PUL1011626		None	Class 1	FT	-	UV	Indoor Use
Bionic IR3	PUL1011628		None	Class 1	BT	-	UV - IR	Brazing, Cutting
Bionic IR5	PUL1011629		None	Class 1	BT	-	UV - IR	Gas welding, Brazing
Clear Face Screen	060511		None	Class 1	B	-	-	Indoor Use
Clear Face IR5	060515		None	Class 1	F	-	UV - IR	Gas welding, Brazing
Clearways Acetate	PUL1002360		None	Class 1	F	-	UV	Indoor Use
Clearways Polycarb.	PUL1002353		None	Class 1	B	-	UV	Indoor Use
Clearways IR5	PUL1002370		None	Class 1	F	-	UV - IR	Gas welding, Brazing

### Lights Hazards & Protection

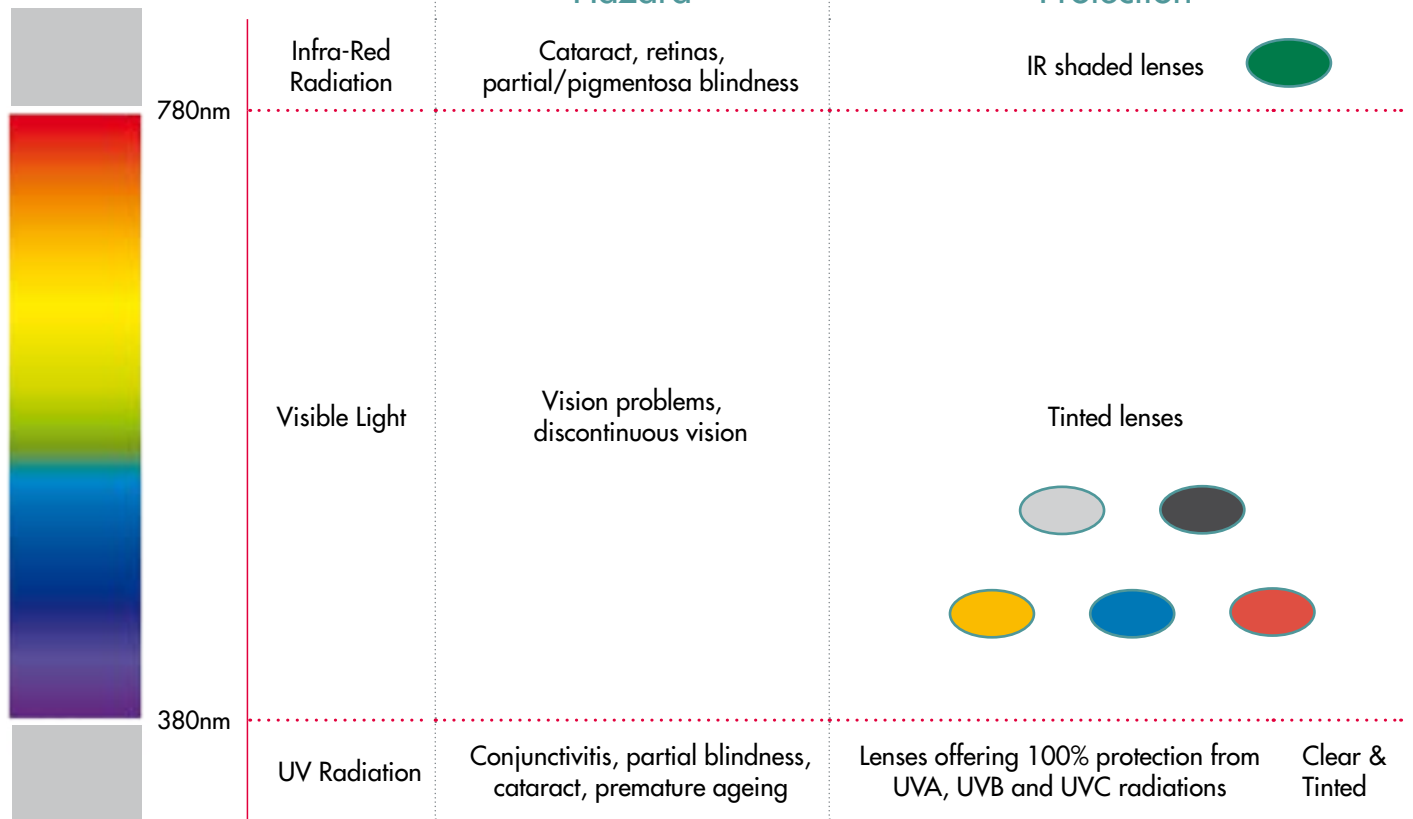

### Lens Colour Guide



**Clear:** For indoor use where eye protection is required against most commonly encountered hazards (i.e.. impact protection). Suitable for industrial manufacturing (metal, chemical, transportation, automotive...).



**I/O - Silver:** For indoor/outdoor use. Ideal for people who constantly move in & out to reduce artificial & sunlight glare. Widely used by fork-lift truck drivers & for indoor/outdoor mechanical work and maintenance.  
*Only 1 pair is required instead of 2 (Clear & Smoke).*



**TSR Grey:** For outdoor use when sunlight & glare can cause eye fatigue. Meets the requirements of Colour Traffic Signal Recognition.



**I.R. 3 & 5:** Protect against radiation resulting from gas welding processes. Suitable for gas welding, brazing, cutting & welder's assistant. NOT suitable for electric arc welding.



**Gold Mirror:** For outdoor use when bright sunlight and glare can cause eye fatigue. The mirror coating keeps the lens clear while reflecting light. Suitable for construction & transport.



**Blue / Red Mirror:** For outdoor use. Suitable for semi conductor fabrication, sodium vapour lighting, yellow lighting. Eliminates glare & eye fatigue in monochromatic yellow lit environments.



### Safety Standards



Certifies only that the product and its manufacture has met the basic safety requirements under directive 89/686/EEC. The product must therefore be checked to ensure it has certification in the EN166 standard for its required use.

**EN166**

Technical Performance Standard: covers the properties of an eye protector such as optical class, mechanical strength & fields of use.

**EN169**

Welding filters

**EN170**

Ultraviolet filters

**EN171**

Infrared filters

**EN172**

Solar protection filters for industrial use.

#### Optical Clarity

**Class 1** Optical class 1 = + 0.06 dioptries (permanent wear)

#### Mechanical Resistance

**B (T)** Impact Grade B = Medium energy impact (120m/s)

**F (T)** Impact Grade F = Low energy impact (45m/s)

T = symbol for protection against impact at extreme temperatures (-5°C / +55°C)

Products without legitimate certification may damage your health irreversibly.

### Glossary of Terms

#### IR Shade:

For welding applications.

IR 1.7: welder's assistant

IR 3: welding, cutting

IR 5: gas welding, brazing, plasma arc welding (up to 0.5 Amps)

IR 7: gas welding, brazing, oxy-acetylene cutting flame, plasma arc welding (up to 2.5 Amps)

#### DX Coating:

A state of the art coating providing protection against mist, scratches, static & chemical attacks.

Only available with 3M Peltor eyewear.

#### Mirror Coating:

A specific sunglare coating providing protection against scratches, UV, sunlight & glare by reflecting harmful light.

### Kromer Caps



- All cotton balloon top, rugged double stitch construction and absorbent, cotton sweat band. Durable & washable
- Individually sized 6-7/8 through 7-7/8, colours supplied at random
- Meticulously constructed and individually inspected in America

Code	Description	Pack
060690	Size 6 7/8 - Style A	10
060691	Size 7 - Style A	10
060692	Size 7 1/8 - Style A	10
060693	Size 7 1/4 - Style A	10
060694	Size 7 3/8 - Style A	10
060695	Size 7 1/2 - Style A	10
060696	Size 7 5/8 - Style A	10
060697	Size 7 3/4 - Style A	10

### Watson Fancy Caps



- Quality welding caps. Comfortable and durable
- Individually sized 7 through 7 5/8, colours supplied at random, reversible
- Designed with the welder in mind

Code	Description	Pack
WAT7	Size 7	10
WAT712	Size 7 1/2	10
WAT714	Size 7 1/4	10
WAT718	Size 7 1/8	10
WAT734	Size 7 3/4	10
WAT738	Size 7 3/8	10
WAT758	Size 7 5/8	10

### Weldas Orange Flame Retardant Hood



- Made of flame retardant fabric
- Velcro closure and velcro to attach to the welding gear
- Certified EN11611

Code	Description	Pack
WEL23-6690	Orange Hood	10

### Weldas Winter Helmet Liner



- Comfortable, warm winter liners for the harshest weather environments
- Soft pliable fabric with multi layering technology to allow sweat vapour to escape whilst keeping the hot & cold weather out
- Flame retardant

Code	Description	Pack
WEL23-7701	Liner Head Protector	10
WEL23-7702	Helmet - Blue - MLD MOD	10
WEL23-7733	Helmet - Blue - MOD SEVER	10

## Futuris Genuine Proban Hood with Cape



- Blue welding hood and cape from the Futuris range.
- Flame retardant.
- PROBAN® treated material.

Code	Description	Pack
060800	Proban Hood	1

## Futuris Flame Retardant Hood with Cape



- Welding hood and cape from the Futuris range
- Flame retardant
- Drawstring option available

Code	Description	Pack
FUTFRHOOD	Hood c/w Cape	1
FUTFRHOODSTRING	Hood c/w Cape & Drawstrings	

## Buff® Professional - Fire Resistant Buff®



- Fire Resistant Buff® is a tubular garment made with DuPont™ Nomex® and XLA™ for greater comfort
- Fireproof and antistatic
- Certified as Personal Protective equipment PPE
- EN340, ENISO 11612-08 and EN1149-5/08

Code	Description	Pack
BUFF68502.00	FR Buff - Desert Tan	1
BUFF68501.00	FR Buff - Forest Green	1
BUFF68500.00	FR Buff - Paris Blue	1
BUFF68503.00	FR Buff - Red	1

## Chrome Leather Accessories



- Comfortable welders skull cap from the popular Futuris range.
- Worn over the head to provide protection from sparks, spatters & heat
- Chrome leather
- Elasticated to ensure "one size fits all"

Code	Description	Pack
060213	Chrome Skull Cap	1

### Portwest- Bizweld™ Flame Retardant Coverall



- Offers complete protection to workers exposed to heat
- Generous fit allows the wearer to work unhindered
- Ample storage space, rule pocket and concealed mobile phone pocket holds equipment securely



EN SO 11612  
A1+A2, B1  
C1,E1,F1



EN ISO 11611  
Class 1  
A1+A2

Code	Description	Pack
PORBIZ1NARM	BIZ1 - Red - Medium - Leg 31"	1
PORBIZ1NARL	BIZ1 - Red - Large - Leg 31"	1
PORBIZ1NARXL	BIZ1 - Red - X Large - Leg 31"	1
PORBIZ1NARXXL	BIZ1 - Red - XX Large - Leg 31"	1
PORBIZ1NATM	BIZ1 - Red - Medium - Leg 33"	1
PORBIZ1NATL	BIZ1 - Red - Large - Leg 33"	1
PORBIZ1NATL	BIZ1 - Red - X Large - Leg 33"	1
PORBIZ1NATXXL	BIZ1 - Red - XX Large - Leg 33"	1

Code	Description	Pack
PORBIZ1ORRM	BIZ1 - Orange - Medium - Leg 31"	1
PORBIZ1ORRL	BIZ1 - Orange - Large - Leg 31"	1
PORBIZ1ORRXL	BIZ1 - Orange - X Large - Leg 31"	1
PORBIZ1ORRXXL	BIZ1 - Orange - XX Large - Leg 31"	1
PORBIZ1ORTM	BIZ1 - Orange - Medium - Leg 33"	1
PORBIZ1ORTL	BIZ1 - Orange - Large - Leg 33"	1
PORBIZ1ORTXL	BIZ1 - Orange - X Large - Leg 33"	1
PORBIZ1ORTXXL	BIZ1 - Orange - XX Large - Leg 33"	1

### Portwest - Bizweld™ Iona Flame Retardant Coverall



- Offers visible protection to the wearer
- Clever design features include flame resistant reflective tape on the shoulders, sleeves and legs
- Ample storage including kneepad pockets and a rule pocket



EN SO 11612  
A1+A2, B1  
C1,E1,F1



EN ISO 11611  
Class 1  
A1+A2

Code	Description	Pack
PORBIZ5NARM	BIZ5 - Navy - Medium - Leg 31"	1
PORBIZ5NARL	BIZ5 - Navy - Large - Leg 31"	1
PORBIZ5NARXL	BIZ5 - Navy - X Large - Leg 31"	1
PORBIZ5NARXXL	BIZ5 - Navy - XX Large - Leg 31"	1
PORBIZ5NATM	BIZ5 - Navy - Medium - Leg 33"	1
PORBIZ5NATL	BIZ5 - Navy - Large - Leg 33"	1
PORBIZ5NATXL	BIZ5 - Navy - X Large - Leg 33"	1
PORBIZ5NATXXL	BIZ5 - Navy - XX Large - Leg 33"	1

Code	Description	Pack
PORBIZ5ORRM	BIZ5 - Orange - Medium - Leg 31"	1
PORBIZ5ORRL	BIZ5 - Orange - Large - Leg 31"	1
PORBIZ5ORRXL	BIZ5 - Orange - X Large - Leg 31"	1
PORBIZ5ORRXXL	BIZ5 - Orange - XX Large - Leg 31"	1
PORBIZ5ORTM	BIZ5 - Orange - Medium - Leg 33"	1
PORBIZ5ORTL	BIZ5 - Orange - Large - Leg 33"	1
PORBIZ5ORTXL	BIZ5 - Orange - X Large - Leg 33"	1
PORBIZ5ORTXXL	BIZ5 - Orange - XX Large - Leg 33"	1

### Weldas Lava Brown Jacket



- Heat & flame resistant leather
- Seams are double lock stitched with high strength, high heat resistant, 5 ply KEVLAR® thread
- All rivets and snaps have electrical insulation for safety
- Leather spatter guard at front panel stops shooting spatter

Code	Description	Pack
WEL44-7300/81	Jacket 81 cm Length - L	1

### Futuris Elite Range - Gold Welding Jacket



- Comfortable hard-wearing welders jacket from the popular Futuris range.
- Protects upper body from sparks, spatter & heat
- Superior quality gold leather
- Available in three sizes - L, XL, XXL

Code	Description	Pack
FUTLE-JAC-L-G	Gold Jacket - Large	1
FUTLE-JAC-XL-G	Gold Jacket - X Large	1
FUTLE-JAC-XXL-G	Gold Jacket - XX Large	1

### Futuris Premium Range - Red Welding Jacket



- Comfortable hard-wearing welders jacket from the popular Futuris range.
- Protects upper body from sparks, spatter & heat
- Premium quality Red leather
- Available in three sizes - L, XL, XXL

Code	Description	Pack
FUTLE-JAC-L-R	Red Jacket - Large	1
FUTLE-JAC-XL-R	Red Jacket - X Large	1
FUTLE-JAC-XXL-R	Red Jacket - XX Large	1

### Futuris - Chrome Welding Jacket



- Comfortable hard-wearing welders jacket from the Futuris range
- Protects upper body from sparks, spatter & heat
- Chrome leather
- Available in four sizes - M, L, XL, XXL

Code	Description	Pack
060242M	Chrome Apron - Medium	1
060242L	Chrome Apron - Large	1
060242XL	Chrome Apron - X Large	1
060242XXL	Chrome Apron - XX Large	1

### Weldas Lava Brown Sleeves



- For arm and shoulder protection
- STEERSO<sup>™</sup>uff leather sleeves have innovative over-the-shoulder hanging system for comfort
- The system consists of a 1" elastic strap, divider & adjustable slider
- Eliminates the discomfort of traditional strapping systems around the neck
- Adjustable cuffs with insulated snaps

Code	Description	Pack
WEL44-7023	Sleeves 58cm (23")	1

### Futuris Elite Range - Gold Sleeves



- 18" superior quality welding sleeves
- Protects clothes and arms from sparks, spatters & heat
- Gold leather
- Elasticated top & cuff

Code	Description	Pack
FUTLE-SLE-G	Gold - 18" Sleeves	1

### Futuris Premium Range - Red Welding Sleeves



- 18" premium quality welding sleeves
- Protects clothes and arms from sparks, spatters & heat
- Red leather
- Elasticated top & cuff

Code	Description	Pack
FUTLE-SLE-R	Red - 18" Sleeves	1

### Futuris - Chrome Welding Sleeves



- Welding sleeves from the popular Futuris range
- Chrome sleeves are available with Leather Shoulder Straps or with Elasticated Top & Cuffs

Code	Description	Pack
060246	Chrome Sleeves - Leather Straps	1
060246E	Chrome Sleeves - 17" - Elasticated	1



### Weldas Lava Brown Bib Apron



- Self-balancing bib apron for front middle body protection
- Designed to allow even weight distribution on the user to reduce fatigue
- The unique self-balancing strap system features a 2.5 cm wide canvas strap, quick release buckle, adjustable slider and divider. This system allows a 32 cm waist adjustment.

Code	Description	Pack
WEL44-7142	Bib Apron 107X60cm (42"X24")	1

### Futuris Elite Range - Gold Welding Apron



- Superior quality welding apron, with leather ties from the popular Futuris range
- Protects the wearer from sparks, spatter & heat
- Gold leather
- Buckle fastenings

Code	Description	Pack
FUTLE-APR-G	Gold Apron	1

### Futuris Premium Range - Red Welding Apron



- Premium quality welding apron, with leather ties from the popular Futuris range
- Protects the wearer from sparks, spatter & heat
- Red leather
- Buckle fastenings

Code	Description	Pack
FUTLE-APR-R	Red Apron	1

### Futuris - Chrome Welding Apron



- Welding apron, with cotton ties or leather ties from the quality Futuris range
- Protects the wearer from sparks, spatter & heat
- Chrome leather
- Buckle fastenings
- 24" x 36"

Code	Description	Pack
060241	Chrome Apron - Cotton ties	1
060268	Chrome Apron - Leather ties	1

### Chrome Leather Welding Trousers



- Comfortable welding trousers from the popular Futuris range
- Chrome leather
- Complete with leather belt
- Available in three sizes, L, XL & XXL

Code	Description	Pack
060244L	Chrome Trousers - Large	1
060244XL	Chrome Trousers - X Large	1
060244XXL	Chrome Trousers - XXL	1

### Chrome Leather Spats



- 12" Welding spats from the popular Futuris range to protect shoes and trousers
- Chrome leather
- Velcro back
- Elasticated heel

Code	Description	Pack
060245	Chrome Spats	1



Weldspares has the widest range of 3M™ and Speedglas™ products outside of the 3M™ network.  
Call us now on 01925 666198 with your requirements.

### Blue Hard Safety Helmet



- Comfortable safety helmet from the popular Futuris range.
- Blue plastic helmet, 4 point mounted head harness

Code	Description	Pack
FUTHARDHATBLUE	Blue Hard Hat	1

### White Hard Safety Helmet



- North white plastic safety helmet
- 4 point mounted harness
- A-59 safe type

Code	Description	Pack
FOC933150	White Hard Hat	1

### Titan 1 - Fall Arrest Kit



TITAN Fall Arrest Kit contains:

- TITAN 1-point harness with rear anchorage
- TITAN B1 - 2M shock absorbing lanyard with 2 screw-gate karabiners
- Kit supplied in practical case for storing and protecting your equipment
- Lightweight, waterproof soft plastic casing
- Quick opening zip, comfortable cloth handle

Code	Size	Pack
TIT1011896	1 Point Harness, 2m Lanyard, 2 Karabiners	1

### Titan C3 - Fall Arrest Kit



TITAN Fall Arrest Kit contains:

- TITAN B - 2M shock absorbing lanyard with an 18mm screwgate karabiner and steel scaffold hook 60mm
- User friendly, cost effective fall protection which meets industry and construction compliance requirements

Code	Size	Pack
TIT1008281	2m Lanyard, Karabiner & S.Hook	1

# ► Safety & PPE

## Disposable Protective Clothing

### 3M 4500 Protective Coverall



**3M**

Designed for light-duty protection against non-hazardous liquids & dusts

- Excellent breathability
- Elasticated hood, cuffs, ankles and waist
- 1-way zip with storm flap



Suitable for light-duty cleaning, warehousing, janitorial

Code	Description	Pack
3M4500-W-size	3M 4500 White Protective Coverall Available in S, M, L, XL and XXL	20

### 3M 4515 Protective Coverall



**3M**

Offers protection against hazardous dusts & limited liquid splash

- Excellent breathability
- Low linting
- Elasticated hood, cuffs, ankles and waist
- 2-way zip with storm flap



Suitable for site preparation, insulation, asbestos inspection & removal

Code	Description	Pack
3M4515-W-size	3M 4515 White Protective Coverall Available in S, M, L, XL and XXL	20

### 3M 4510 Protective Coverall



**3M**

Offers protection against hazardous dusts & limited liquid splash

Cost effective alternative to the 4545 without protection against biohazards

- Good breathability
- Ultra low linting
- Elasticated hood, cuffs, ankles and waist
- 2-way zip with storm flap



Suitable for painting & coating, resins, light industrial cleaning & machine maintenance

Code	Description	Pack
3M4510-W-size	3M 4510 White Protective Coverall Available in S, M, L, XL and XXL	20

### 3M 4545 Protective Coverall



**3M**

Provides a good barrier to hazardous particles & limited liquid splash

Premium version of the 4510 with protection against biohazards

- Elasticated hood, ankles and waist / Knitted cuffs
- 3-panel hood
- 2-way zip with fully sealable storm flap
- Good breathability
- Ultra low linting



Suitable for painting & coating, resins, light industrial cleaning, machine maintenance & cleanrooms

Code	Description	Pack
3M4545-size	3M 4545 Protective Coverall Available in S, M, L, XL and XXL	20

### 3M 4535 Protective Coverall



- Large SMMMS breathable back panel (in blue) to increase wearer comfort
- Microporous PE laminate (in white) designed to offer a good barrier against hazardous particles & limited liquid splash
- Elasticated hood, ankles and waist / Knitted cuffs
- 2-way zip with storm flap
- Excellent breathability
- Low linting



3M

Suitable for painting & coating, resins, light industrial cleaning & machine maintenance

Code	Description	Pack
3M4535-size	3M 4535 Protective Coverall Available in S, M, L, XL and XXL	20

### 3M 4540+ Protective Coverall



- SMMMS back panel (in blue) for breathability
- Microporous PE laminate (in white) designed to offer a good barrier against hazardous particles & limited liquid splash
- Elasticated hood, ankles and waist / Knitted cuffs
- 3-panel hood
- 2-way zip with fully sealable storm flap
- Excellent breathability
- Low linting



3M

Suitable for painting & coating, resins, light industrial cleaning & machine maintenance

Alternative to the 4535 when more protection is required

Code	Description	Pack
3M4540+WB-size	3M 4540+ Protective Coverall Available in S, M, L, XL and XXL	20

### 3M Protective Overhood / Oversleeves / Overshoes



442 Overshoes

3M

- Made from PE laminate material offering a general barrier to non-hazardous substances
- Elasticated ankles

Code	Description	Pack
3M442	3M 442 Overshoes White	300



444 Oversleeves

3M

- Made from PE laminate material offering a general barrier to non-hazardous substances
- 40.5cm/16" protection covering wrist to top of arm
- Elastic finish on top end

Code	Description	Pack
3M444	3M 444 Oversleeves White Elasticated Cuffs	300



446 Overhood

3M

- Made from PE laminate material offering a general barrier to non-hazardous substances
- Anti-static treated fabric
- Drapes over the shoulders offering excellent coverage

Code	Description	Pack
3M446	3M 446 Overhood White	300

### Dry Cool Buff®

Seamless tubular Dry-Cool Buff® is made with Coolmax® Extreme fabric and is ideal for use in warm/sunny climates or during the hottest months of the year

Coolmax® Extreme is engineered with a special four-channel fibre for state-of-the-art moisture management properties which allows the fast absorption and drying of body moisture while giving 95% protection from solar UV rays

Standard Dry-Cool Buff® is available in the designs shown and can incorporate two retro-reflective stripes of 3M Scotchlite™ for enhanced visibility in poor light conditions

- Fast Drying
- 95% Protection from UV rays
- Highly breathable fabric
- Available with 3M Scotchlite™ reflective tape



#### Ways to wear



HEADBAND



BONNET



PIRATE



UNDER-HELMET



BALACLAVA



BUFF16318.00

Dry-Cool  
Orange Fluo



BUFF16002.00

Dry-Cool  
Navy



BUFF16005.00

Dry-Cool  
Black



BUFF16003.00

Dry-Cool  
Yellow Fluo



BUFF16006.00

Dry-Cool  
White



BUFF16313.00

Dry-Cool  
Camu



BUFF101802.00

Dry-Cool  
Digital Arid



BUFF16319.00

Dry-Cool  
Reflective  
Orange Fluo



BUFF16000.00

Dry-Cool  
Reflective  
Navy



BUFF16004.00

Dry-Cool  
Reflective  
Black



BUFF16001.00

Dry-Cool  
Reflective  
Yellow Fluo



BUFF16314.00

Dry-Cool  
Camu-2



BUFF16315.00

Dry-Cool  
Camu Duna



BUFF101801.00

Dry-Cool  
Digital Tropical

## Chefs Collection

The Chefs Collection from Original Buff® is composed of multifunctional headwear made with Coolmax® fabric, ideal for many kitchen and catering tasks

Thanks to its design, the Chefs Collection keeps hair tidy and away from the face and food, and absorbs perspiration. In addition, this product offers a quick drying and odour control with Polygiene® Technology

Available in 6 designs created for hospitality and catering industries: modern, original and innovative

- Keeps hair tidy & away from the face and food
- Absorbs perspiration
- Quick drying
- Odour control with Polygiene Technology



Ways to wear



BUFF16321.00  
Dry-Cool  
Utensils



BUFF16323.00  
Dry-Cool  
Napoli



BUFF16320.00  
Dry-Cool  
Fruits



BUFF16322.00  
Dry-Cool  
Nippon



BUFF16006.00  
Dry-Cool  
White



BUFF16005.00  
Dry-Cool  
Black

### Thermal Buff®

Seamless tubular Thermal Buff® is made with Thermolite®, an excellent insulating fabric manufactured from hollow-core fibres. It also wicks body moisture away from the skin to help maintain body temperature and wearer comfort in cold weather

Thermal Buff® is available in the designs shown and can incorporate two retro-reflective stripes of 3M Scotchlite™ for enhanced visibility in poor light conditions

- Breathable Fabric
- Maintains body temperature in cold weather
- Available with 3M Scotchlite™ reflective tape



Ways to wear



NECKERCHIEF



SCARF



BALACLAVA



MASK



UNDER-HELMET



BUFF16507.00  
Thermal Buff®  
Orange Fluo



BUFF16502.00  
Thermal Buff®  
Navy



BUFF16505.00  
Thermal Buff®  
Black



BUFF16503.00  
Thermal Buff®  
Yellow Fluo



BUFF16506.00  
Thermal Buff®  
White



BUFF16508.00  
Thermal Buff®  
Reflective  
Orange Fluo



BUFF16500.00  
Thermal Buff®  
Reflective  
Navy



BUFF16504.00  
Thermal Buff®  
Reflective  
Black



BUFF16501.00  
Thermal Buff®  
Reflective  
Yellow Fluo



BUFF16802.00  
Thermal Buff®  
Green Forest



### Polar Buff®

Polar Buff® is made from a seamless tube of Thermolite® sewn to a tube of Polartec® fleece fabric. This clever combination helps to combat heat loss and thus maintain body temperature in cold weather

Polar Buff® is available in the designs shown and can incorporate two retro-reflective stripes of 3M Scotchlite™ for enhanced visibility in poor light conditions

- Maintains body temperature in cold weather
- Available with 3M Scotchlite™ reflective tape



Ways to wear



BUFF47003.00  
Polar Buff®  
Yellow Fluo



BUFF47002.00  
Polar Buff®  
Navy



BUFF47005.00  
Polar Buff®  
Black



BUFF47300.00  
Polar Buff®  
Green Forest



BUFF47001.00  
Polar Buff®  
Reflective  
Yellow Fluo



BUFF47000.00  
Polar Buff®  
Reflective  
Navy



BUFF47004.00  
Polar Buff®  
Reflective  
Black



BUFF101828.00  
Polar Buff®  
White

### Windproof Buff®

Windproof Buff® is made from a tube of Windstopper® fabric with a Polartec® lining sewn to a double layer of Thermolite®. This double layer of fabrics traps air between the garment and the wearer's skin which means Windproof Buff® offers the wearer optimum wind protection with insulation

Windproof Buff® is available in the designs shown and can incorporate two retro-reflective stripes of 3M Scotchlite™ for enhanced visibility in poor light conditions

- Maintains body temperature in cold weather
- Protects from wind chill
- Available with 3M Scotchlite™ reflective tape



#### Ways to wear



BUFF68009.00  
Windproof Buff®  
Yellow Fluo



BUFF68008.00  
Windproof Buff®  
Navy



BUFF68011.00  
Windproof Buff®  
Black



BUFF68007.00  
Windproof Buff®  
Reflective  
Yellow Fluo



BUFF68006.00  
Windproof Buff®  
Reflective  
Navy



BUFF68010.00  
Windproof Buff®  
Reflective  
Black

## Fire Resistant Buff®

Fire Resistant Buff® is a tubular garment made with DuPont™ Nomex® and XLA™ for greater comfort. Antistatic and resistant to fire, Fire Resistant Buff® is certified as Personal Protective Equipment (PPE) and protects the wearer under standards EN340, EN ISO 11612-08 and EN1149-5/08.

Fire Resistant Buff® is ideal for electrical, chemical, petrochemical and other industrial workers. It is also suitable for police officers, military personnel and fire fighters who also require protection from heat and flames, other thermal hazards and potentially explosive environments.

- Fireproof and antistatic
- Made of Dupont™ Nomex Fabric
- Certified as Personal Protective equipment PPE
- EN340, ENISO 11612-08 and EN1149-5/08



DuPont™  
**Nomex®**



Ways to wear



BUFF68502.00  
Fire Resistant Buff®  
Desert Tan



BUFF68501.00  
Fire Resistant Buff®  
Forest Green



BUFF68500.00  
Fire Resistant Buff®  
Paris Blue



BUFF68503.00  
Fire Resistant Buff®  
Red

### Visor Buff®

Visor Buff® is a new concept for caps made to be used during the hottest months of the year.

It consists of a 100% neoprene peak sewn to a Dry-Cool Buff® headwear which, thanks to the Coolmax® Extreme fabric, quickly wicks away perspiration while blocking 95% of UV rays and offering excellent breathability.

Visor Buff® is designed for a wide range of outdoor jobs.

- Highly Breathable fabric
- Fast drying
- 95% protection from UV rays



#### Ways to wear



BUFF68700.00  
Visor Buff®  
Black



BUFF68701.00  
Visor Buff®  
Navy



BUFF68703.00  
Visor Buff®  
Orange Fluo



BUFF68702.00  
Visor Buff®  
Yellow Fluo



BUFF68705.00  
Visor Buff®  
Camu



BUFF68706.00  
Visor Buff®  
Camu Duna



BUFF68704.00  
Visor Buff®  
White



Sprays & Pastes

232

Marking

233-234

# Sprays, Pastes & Markers ▶▶

# ► Sprays, Pastes & Markers

## Sprays & Pastes

### Crack Detection / Metal Working Sprays

Used as part of a three-step process for detecting faults in welds, castings, exotic alloys and standard metals. Faults could be cracks, pin holes or welding laps on the metal surface. 400ml aerosols



Code	Description	Pack
070540	Cleaner	1
070541	Penetrant	1
070542	Developer	1

### Leak Detector



Detector spray specially developed to rapidly locate the source of a gas leak by producing a microporous stable foam showing up the smallest leak instantly.

- Suitable for use with most positive pressure gas systems.
- 300ml aerosol



Code	Description	Pack
070514	Leak Detector Spray - 300ml	1

### Anti-Spatter

For use on all forms of welding to prevent the adhesion of spatter. Apply to workpieces, shrouds & nozzles as well as jigs, tools & fixtures. Available in 300ml spray and in water-based 5L and 25L drums.



Code	Description	Pack
070525	Non-flammable Spray 300ml	1
070510	Water-based Drum 5L	1
070517	Water-based Drum 25L	1
070520	Cleanweld Spray 600ml	1

### Polinox Pickling Pastes

Top quality pickling pastes made in EU and free from hydrochloric acid and chlorides. Pickling ensures the corrosion resistance of components made of stainless steel, increasing considerably their service life and usefulness.

- The Polinox-P Rapid pickling paste is a high strength orange pickle paste which quickly and completely removes heavy scale and burning from high alloy materials.
- The Polinox-P Normal pickling paste is a standard white pickle paste which quickly and efficiently removes scale, discolouration and ferritic contamination from seam welds.
- Surface treatment brush included



**POLIGRAT**

Code	Description	Pack
070602	Rapid Pickling Paste 2kg	1
070604	Normal Pickling Paste 2.5kg	1
070750	Brush	1

### Futuris Tip-Dip Paste

- Prevents adhesion of spatter on the welding nozzle, prolonging working life
- Non-flammable, non-toxic & solvent free



Code	Description	Pack
FUT529-646	Tip-Dip Paste	1

### French Chalk / Soapstone



Flat



Square



Soapstone sticks used for temporary marking.

- Available in 100x10x10mm square sticks and 125x12x5mm flat sticks.
- A chalk holder for flat sticks is also available.

Code	Description	Pack
040690	Flat 125x12x5mm	144
040691	Square 100x10x10mm	50
040692	Flat Chalk Holder	1

### Tempilstik

Genuine Tempilstik® - The industry's best-selling temperature indicator for over 70 years.

Inexpensive alternative for surface temperature measurement, Tempilstik® is a simple and easy-to-use surface indicator that delivers reliable and accurate results, with no gauges or calibration required.

Easy-to-use: simply stroke the workpiece during heating. Once the surface reaches the indicator's rated temperature, the Tempilstik® will make a distinct mark by melting at the point of contact, changing appearance from chalky to glossy.

Available in a wide variety of temperatures from 38°C to 1093°C (100°F to 2000°F)

- Reliably accurate - melts within +/- 1% of rated temperature
- Provides strong chalk grip to avoid slippage



Applications:

- Welding and metal fabrication, surface preheating, annealing, stress-relieving, post-weld heat treatment, machine and equipment operations

Code	Description	Pack
TMP.../...	Temperature range 100F to 2000F	10
	Temperature range 38C to 1093C	

### Nissen Paint Markers

- Mark permanently on any surface: rusty, smooth, wet, dry or oily
- Fast-drying lead-free colours
- Mark on metal, wood, plastic, glass, ceramics, rubber, paper, cardboard, textiles...



#### Ball Paint Marker - 1/8"

1/8" precision stainless steel ball. Will write in any position: horizontal, vertical and even overhead. Also available in an unbreakable plastic bottle.



Code	Description
JPN00201	Ball Paint 1/8" White
JPN00204	Ball Paint 1/8" Yellow
JPN00420	Ball Paint Bottle White
JPN00421	Ball Paint Bottle Yellow

#### Solid Paint Marker - Smooth, fast and easy marking

Solid stick of paint which can be conveniently carried in your pocket. Marks even under water. Available in standard (~ 5/16") and jumbo (~ 1/2") versions



Code	Description
JPN00300	Solid White
JPN00301	Solid Yellow
JPN00310	Solid Jumbo White
JPN00311	Solid Jumbo Yellow

#### Feltip Paint Marker - Unique precision valve to accurately meter flow

Dispenses a fast-drying high-gloss enamel paint for permanent marking. 1/8" wide mark. Fine Line version is approximately 0.75mm wide.

The Galvanizer's Feltip Paint Marker dispenses a paint especially formulated for fabricators who have their material galvanized.



Code	Description
JPN00350	Feltip White
JPN00351	Feltip Yellow
JPN00370	Feltip Fine Line White
JPN00371	Feltip Fine Line Yellow
JPN00570	Galvanizer's Feltip White

### Markal Paint Markers

#### B Paintstik® Marker - Marks on any material or surface.

For use on metal, wood, plastic, concrete, rubber, glass, cardboard and paper. Marks on smooth, rough, rusty or dirty surfaces and also through oil and water.

- Real lead-free paint in stick form combining the long-lasting durability of paint with the ease-of-use of a crayon.
- Temperature range: -46°C to +66°C (-50°F to 150°F)

#### P Paintstik® Marker - Dissolves in pickling baths.

For marking steel prior to galvanizing. Marks do not dry and are completely removed in the pickling bath, but will not interfere with the galvanizing process.

- Size: 11/16" x 4-3/4"
- Temperature range: -46°C to +66°C (-50°F to 150°F)

#### B-L Paintstik® Marker - Bleeds through solvent-based paints.

For fabricating structural steel or layout work where the marks are required to bleed through a primer coat covering the marks.

- To prevent bleeding through the finish coat: seal the marked areas with water-based epoxy paint.
- Marks bleed through solvent-based or oil-based paints.
- Temperature range: -46°C to +66°C (-50°F to 150°F)



Code	Description
MKL80220	B Paintstik® White
MKL80221	B Paintstik® Yellow
MKL83420	P Paintstik® White
MKL80725	Bleed-Through Paintstik®





Locking Clamps & Inspection Mirrors

236

Rap-Arounds, Welding Clamps & Pipe Jacks

237

Welding Tables

238

# Welding Tools ▶▶

# Welding Tools

## Locking Clamps & Inspection Mirrors

### Self-Adjusting Locking Clamps & Pliers

Automatic Locking Pliers & Locking Clamps. Automatically locks on any size without adjusting. Jaws to adjust to any size object with one simple one-handed operation. Set and forget pressure control!



C-Clamp



Needle Nose  
Ideal for those hard-to-reach jobs



C-Clamp c/w Swivel Tips



Curved Jaw



Code	Type	Size	Jaw Width	Clamp Depth	Code	Type	Size	Jaw Width
HAN-7CC	C-Clamp	7" - 175mm	0-68mm	55mm	HAN-6CJ	Curved Jaw	6" - 150mm	0-32mm
HAN-11CC	C-Clamp	11" - 275mm	0-90mm	76mm	HAN-10CJ	Curved Jaw	10" - 250mm	0-47mm
HAN-11CCS	C-Clamp c/w Swivel Tips	11" - 275mm	0-90mm	76mm	HAN-7NN	Needle Nose	7" - 175mm	0-51mm

### Inspection Mirrors

Brushed finish stainless steel mirror backs allowing fast and accurate visual inspection of hidden areas with an almost limitless number of positions. Manufactured from tempered spring steel to withstand the stresses of constant repositioning.



OULM8B-2



OULM8E-2T



OULM8C-2



OULM81830

Code	Description	Diam.	Extension Length
OULM8B-2	Oval Pocket Inspection Mirror	25 x 50mm	220mm
OULM8A-2T	Circular Telescopic Inspection Mirror	22mm	114 - 457mm
OULM8E-2T	Circular Telescopic Inspection Mirror	32mm	114 - 470mm
OULM8C-2	Circular Telescopic Inspection Mirror	57mm	254 - 356mm
OULM81830	Pocket Scriber with Magnet	-	138mm

### Rap-Around Pipe Mark



- Welders & Pipe Fitters "Rap-Around" from the popular Futuris range
- An inexpensive tool for marking straight lines around pipes or for use as a straightedge
- Made out of flexible gasket material with good resistance to heat and cold
- Double ruled so both the top and bottom surfaces can be used for layouts - its never upside-down
- Packaged in its own clear plastic tube to protect it between uses
- 12 per case
- BWSRA184HT enables the user to cut the Rap-Around to desired length

Code	Description	Pack
BWSRA160HT	4"X4" High Temp for 3-6" pipe	12
BWSRA170HT	4"X6" High Temp for 3-10" pipe	12
BWSRA177HT	4"X7" High Temp for 4-12" pipe	12
BWSRA179HT	4"X9" High Temp for 6-16" pipe	12
BWSRA184HT	4"XDesired" High Temp for 3-6" pipe	

### Pipe Welding Clamp



- Manufactured from forged steel for increased strength
- Stainless steel roller balls are fitted as standard to the wing bolts
- Wing bolts with stainless steel bearings
- Can be used on stainless steel by fitting the optional stainless steel feet to prevent contamination
- Weight 1.40kg

Code	Description	Pack
800825	JA Clamp Type - 1-3" / 25-75mm	1
800835	JA Clamp Type - 2-5" / 50-125mm	1
800845	JA Clamp Type - 5-9" / 125-225mm	1
800855	JA Clamp Type - 10-14" / 255-355mm	1

NB: Must not be used as a lifting device, as they may result in damage or injury

### Rigid Pipe Jack - c/w V Head



- A cost effective solution for any pipe handling problem
- Constructed from box section for strength and designed with safety features to prevent sudden collapse of the pipe
- Adjustable in height from 27" to 48" with a threaded head for fine adjustment
- Pipe stands are available with a choice of slip-on, or interchangeable head styles for rotation or transferal movement of pipe and plate
- 1000kg capacity - Colour will vary

Code	Description	Pack
800800	JA Clamp Type - 1-3" / 25-75mm	1

### Portable Folding Welding Table



30mm hole on 4 corners  
to hold MIG torches

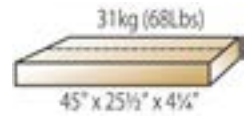

**FUTURIS**

- Portable Folding Welding Table from our popular Futuris range
- Galvanised 14G steel sheet table top
- Table dimensions 40" L X 24" W (100X60cm)
- Foldable leg frame
- Load Capacity 180kg (400lbs)
- 2pc X 6" wheel kit (optional)
- Shipping weight 31Kg (68lbs)

Code	Description	Pack
FUTMTABLE2	MIG Welding Table 180kg	1

### Portable Welding Table



Tab for ground clamp  
and 30mm hole for  
MIG torches



**FUTURIS**

- Portable Welding Table from our popular Futuris range
- Galvanised 14G steel sheet table top
- Table dimensions 36" L X 20" W (90X50cm)
- Slag tray
- Load Capacity 100kg (220lbs)
- 4pc X 2.5" castors (optional)
- Shipping weight 20Kg (44lbs)

Code	Description	Pack
FUTMTABLE4	MIG Welding Table 100kg	1